

# Integra<sup>®</sup> MicroFrance<sup>®</sup>

## ENT Instrumentation Catalog





**Micronance®**



## Warranty

- A. This LIMITED WARRANTY provides assurance for the customer who purchases an Integra Product (hereinafter the “Product”) that should the Product fail to function to Integra’s published specifications during the term of this LIMITED WARRANTY (one year from the date of shipment for new Product), that Integra will at its option either replace, repair, or issue a credit (adjusted to reflect the age of the Product) for the Product or any portion thereof. This LIMITED WARRANTY is extended only to the buyer purchasing the Product directly from Integra or from its affiliate or its authorized distributor or representative.
- B. To qualify for this LIMITED WARRANTY, the following conditions must be met:
- (1) The Product must be used on or before its “Use By” or “Use Before” date, if applicable.
  - (2) The Product must be used in accordance with its labeling and may not be altered or subjected to misuse, abuse, accident or improper handling.
  - (3) Integra must be notified in writing within thirty (30) days following discovery of a defect.
  - (4) The Product must be returned to Integra within thirty (30) days of Integra receiving notice as provided for in (3) above.
  - (5) Upon examination of the Product by Integra, Integra shall have determined that: (i) the Product was not repaired or altered by anyone other than Integra or its authorized representative, (ii) the Product was not operated under conditions other than normal use, and (iii) the prescribed periodic maintenance and services have been performed on the Product.
- C. This LIMITED WARRANTY is limited to its express terms. THIS LIMITED WARRANTY IS IN LIEU OF ALL OTHER WARRANTIES, EXPRESSED OR IMPLIED WHETHER STATUTORY OR OTHERWISE, INCLUDING ANY IMPLIED WARRANTY OF MERCHANTABILITY OR FITNESS FOR A PARTICULAR PURPOSE. In no event shall Integra be liable for any consequential, incidental, prospective or other similar damage resulting from a defect, failure, or malfunction of the Product, whether a claim for such damage is based upon the warranty, contract, negligence or otherwise.
- D. The exclusions and limitations set out above are not intended to, and should not be construed so as to, contravene mandatory provisions of applicable law. Users may benefit from statutory warranty rights under legislation governing the sale of consumer goods. If any part or term of this LIMITED WARRANTY is held by any court of competent jurisdiction to be illegal, unenforceable, or in conflict with applicable law, the validity of the remaining portion of the LIMITED WARRANTY shall not be affected, and all rights and obligations shall be construed and enforced as if this LIMITED WARRANTY did not contain the particular part or term held to be invalid.

## Ordering Procedure

A written purchase order on customer’s form may be requested for purchase of Integra products.

## Acceptance of Order

Orders are accepted upon approval by Integra.

## Returned Goods Policy

Products must be returned in unopened packages with manufacturer’s seals intact to be accepted for replacement or credit unless returned due to a complaint of product defect. Determination of a product defect will be made by Integra. Products will not be accepted for replacement if they have been in the possession of the customer for more than 90 days.

## Repairs and Maintenance

Should your instruments require repair or maintenance, contact Integra for return authorization and address. Instruments returned to Integra for repair must have a statement testifying that each instrument has been thoroughly cleaned and sterilized. Failure to supply evidence of cleaning and disinfection will result in a cleaning charge and delayed processing of your instrument repair.

## Product Information Disclosure

Integra and its subsidiaries ("Integra") and manufacturer exclude all warranties, except Integra's applicable standard warranty whether expressed or implied, including but not limited to, any implied warranties of merchantability or fitness for a particular purpose. Neither Integra nor manufacturer shall be liable for any incidental or consequential loss, damage, or expense, directly or indirectly arising from use of these products. Neither Integra nor manufacturer assume nor authorize any person to assume for them any other or additional liability or responsibility in connection with these products.

## Care and Handling/IFU

For Care and Handling information and Instructions for Use, please visit [www.integralife.com/microfrance](http://www.integralife.com/microfrance)



Product complies with the requirements of directive 93/42/EEC



Integra LifeSciences Services France  
Immeuble Séquoia 2  
97 allée Alexandre Borodine  
Parc Technologique de la Porte des Alpes  
69800 Saint Priest ■ France  
+33 (0) 4 37 47 59 10



Integra MicroFrance SAS  
Le Pavillon, 03160  
Saint-Aubin-le-Monial ■ France



Integra York PA, Inc.  
589 Davies Drive  
York, PA 17402 ■ USA

Tolerances in product specifications, due to the hand craftsmanship of the instruments, are subject to minor variations in dimensions and finishes.

©2016 Integra LifeSciences Corporation.  
All Rights Reserved.

# Table of Contents

## Integra® ENT Instrumentation

Otology Instruments .....	5
Nasal and Sinus Instruments .....	63
General Throat Instruments .....	119
Laryngeal Instruments .....	131
Plastic Surgery Instruments.....	141
General Instruments.....	163

## Integra® MicroFrance®

General Instrumentation.....	173
General Throat Instruments .....	193
Head and Neck Instrumentation.....	207
Laryngeal Instrumentation .....	211
Maxillofacial Instruments .....	245
Otology Instrumentation .....	251
Plastic Surgery Instrumentation .....	307
Sinus Instrumentation.....	337

## Indices

Numerical Index .....	386
Alphabetical Index .....	404



INTEGRA<sup>®</sup>  
LIMIT UNCERTAINTY



Integra<sup>®</sup>  
ENT Instrumentation  
Otology Instruments



### Buck Ear Currettes, Angled, Sharp

Overall length 165mm (6½")

Catalog #	Description
3724001	1.0mm, Size 00
3724002	1.5mm, Size 0
3724003	2.0mm, Size 1
3724004	2.5mm, Size 2
3724005	3.0mm, Size 3



### Buck Ear Currettes, Straight, Sharp

Overall length 165mm (6½")

Catalog #	Description
3724006	1.0mm, Size 00
3724007	1.5mm, Size 0
3724009	2.5mm, Size 2



### Buck Ear Currettes, Angled, Blunt

Overall length 165mm (6½")

Catalog #	Description
3724011	1.0mm, Size 00
3724012	1.5mm, Size 0
3724013	2.0mm, Size 1
3724014	2.5mm, Size 2
3724015	3.0mm, Size 3



### Buck Ear Currettes, Straight, Blunt

Overall length 165mm (6½")

Catalog #	Description
3724016	1.0mm, Size 00
3724017	1.5mm, Size 0
3724018	2.0mm, Size 1
3724019	2.5mm, Size 2
3724020	3.0mm, Size 3



**Lempert Endural Curette**

Overall length 203mm (8")

Catalog #	Description
3724043	1.5 x 3.0mm Cup
3724044	2.0 x 3.5mm Cup
3724045	2.5 x 4.0mm Cup
3724046	3.0 x 4.5mm Cup
3724047	3.5 x 5.0mm Cup



**Shapleigh Ear Curette**

Overall length 152mm (6")

Catalog #	Description
3724022	Size 2, 2.0mm, Serrated



**Sprague Ear Curette**

Overall length 178mm (7")

Catalog #	Description
3724023	Small, 2.0mm Loop
3724024	Large, 3.0mm Loop



**Periosteal ENT Elevator**

Overall length 193mm (7½")

Catalog #	Description
3724059	6.5mm, Curved, Heavy



**Lempert Elevator**

Overall length 184mm (7¼")

Catalog #	Description
3724060	7.0mm, Curved



**Dean Periosteotome**

Catalog #	Description
3724065	Overall length 158mm (6¼")





**Alligator Forceps, Very Fine, Panther**

Working length 80mm (3 1/8")

Catalog #	Description
3721023	3.0mm, Serrated Jaws
3721024	4.0mm, Serrated Jaws



**Alligator Forceps, Miniature**

Working length 80mm (3 1/8")

Catalog #	Description
3721028	4.5mm, Smooth Jaws



**Alligator Forceps, Very Fine**

Working length 80mm (3 1/8")

Catalog #	Description
3721036	0.9 x 4.0mm, Straight, Serrated
3721025	0.9 x 6.0mm, Straight, Serrated



**Bellucci Alligator Forceps, Delicate**

Working length 87mm (3 3/8")

Catalog #	Description
3721014	8.0mm, Straight, Serrated



**Corgill-Hartman Ear Forceps**

Working length 85mm (3<sup>3</sup>/<sub>8</sub>" )

Catalog #	Description
3724265	1.7 x 3.0mm, Straight, Serrated



**Duckbill Ear Forceps**

Working length 87mm (3<sup>3</sup>/<sub>8</sub>" )

Catalog #	Description
3721004	2.0 x 8.0mm, Straight, Flat Serrated



**Ear Cup Forceps, Delicate**

Working length 75mm (3" )

Catalog #	Description
3721041	0.75mm Cups

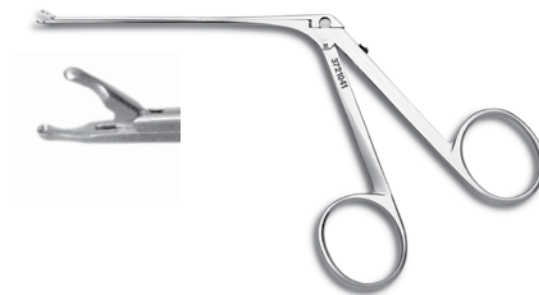

**Ear Cup Forceps, Extra Long**

Working length 135mm (5<sup>3</sup>/<sub>8</sub>" )

Catalog #	Description
3721042	1.0mm, Straight
3721043	1.0mm, Curved Left
3721044	1.0mm, Curved Right



3721042



**Ear Forceps, Angled, Very Fine**

Working length 82mm (3¼")

Catalog #	Description
3721030	4.0mm, 45° Angled Up, Serrated



**Ear Forceps, Very Fine**

Working length 82mm (3¼")

Catalog #	Description
3721032	0.9 x 2.0mm, Oblong Cups



**Greven Ear Forceps**

Working length 75mm (3")

Catalog #	Description
3721029	1.4mm, Serrated Tip



**Hartman Ear Forceps**

Working length 64mm (2½")

Catalog #	Description
3721000	1.5 x 6.0mm, Straight, Serrated



**Hartman-Herzfeld Ear Forceps**

Working length 87mm (3<sup>3</sup>/<sub>8</sub>" )

Catalog #	Description
3724266	2.0mm Cups
3721006	3.0mm Cups
3721007	2.0mm Up-Biting Cups

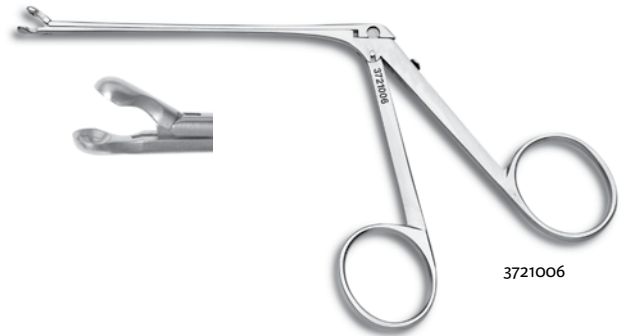

3721006

**Hough Crura Nipper Forceps, Very Fine**

Working length 82mm (3<sup>1</sup>/<sub>4</sub>" )

Catalog #	Description
3721012	45° Angled Right
3721013	45° Angled Left



3721013

**House Alligator Crimping Forceps**

Working length 87mm (3<sup>3</sup>/<sub>8</sub>" )

Catalog #	Description
3721018	8.0mm, Straight, Serrated, Fine

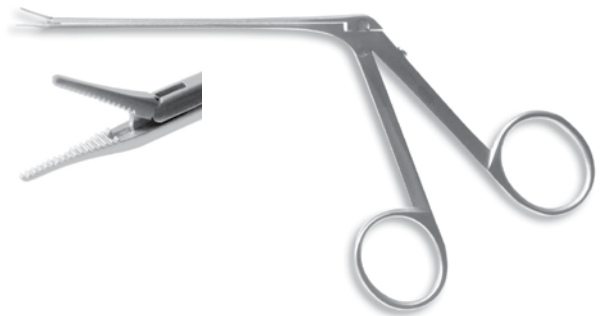

**House Cup Forceps**

Working length 82mm (3<sup>1</sup>/<sub>4</sub>" )

Catalog #	Description
3721021	0.9mm Cups, 25° Angled Right
3721022	0.9mm Cups, 25° Angled Left



3721021



### House Miniature Forceps

Working length 78mm (3 1/8")

Catalog #	Description
3721026	4.5mm, Serrated, Delicate
3721027	3.0mm, Serrated, Extra Delicate



3721026

### House Strut Forceps

Working length 82mm (3 1/4")

Catalog #	Description
3721020	6.0mm, Smooth, Fine



### House-Wullstein Miniature Cup Forceps

Working length 82mm (3 1/4"), Oval Cups

Catalog #	Description
3721037	0.6 x 1.2mm, Straight
3721038	0.6 x 1.2mm, Angled Left
3721039	0.6 x 1.2mm, Angled Right
3721040	0.6 x 1.2mm, Angled Up



3721037

### Juers Crimper Forceps, Very Fine

Working length 82mm (3 1/4")

Catalog #	Description
3724269	3.0mm, Offset Left, Serrated
3724370	3.0mm, Offset Right, Serrated



3724370

**KOS Crimping Forceps**

Working length 80mm (3 1/8")

Catalog #	Description
3721016	3.5mm, Very Fine



**McGee Malleus Crimping Forceps**

Working length 82mm (3 1/4")

Catalog #	Description
3721009	3.5mm, Straight
3721008	4.5mm, 30° Angled Down



**Noyes Ear Dressing Forceps**

Working length 87mm (3 3/8")

Catalog #	Description
3721002	8.0mm, Straight, Serrated

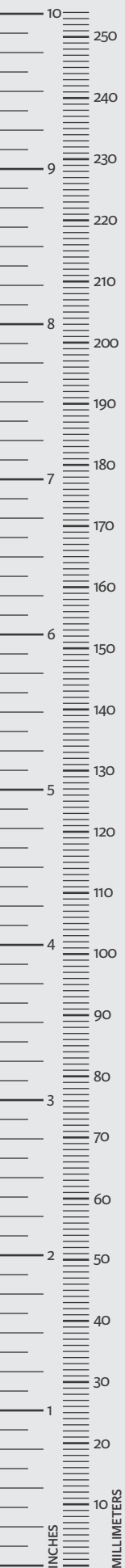

**Schuknecht Wire Crimping Forceps**

Working length 80mm (3 1/8")

Catalog #	Description
3721015	6.0mm Jaws



**Struempel Ear Forceps, Fine**

Working length 87mm (3 3/8")

Catalog #	Description
3721005	2.5 x 5.0mm, Fenestrated Jaws

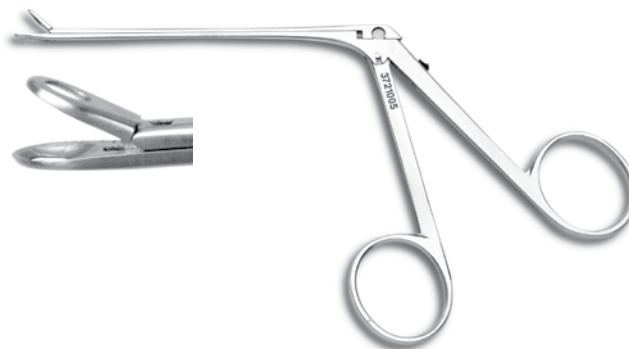

**Tobey Ear Forceps**

Working length 61mm (2 3/8")

Catalog #	Description
3721001	2.0 x 4.0mm, Delicate

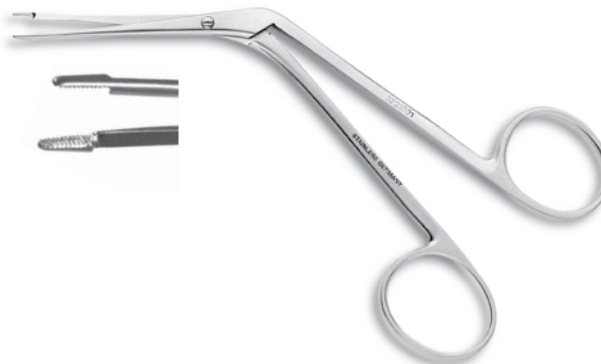

### Sheehy Ossicle Holding Clamp

Overall length 118mm (4<sup>5</sup>/<sub>8</sub>"

Catalog #	Description
3721059	4.0mm Jaws, 1.5mm Groove



### Derlacki Ossicle Holding Clamp

Overall length 124mm (4<sup>7</sup>/<sub>8</sub>"

Catalog #	Description
3721060	1.5 x 5.0mm, Vertical Groove 1.5 x 2.0mm, Horizontal Groove

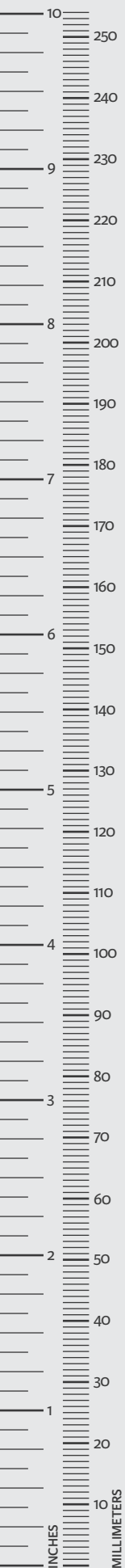
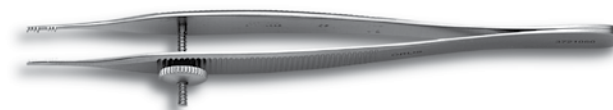



### Allport Incus Hook

Overall length 166mm (6½")

Catalog #	Description
3724307	5.5mm, 90° Angled



### Gross Ear Hook and Spoon

Overall length 125mm (4¾"), Double-Ended

Catalog #	Description
3724026	3.0 x 7.5mm Spoon, 1.5 x 3.0mm 90° Hook



### Day Ear Hook

Overall length 145mm (5¾")

Catalog #	Description
3724027	2.5mm, X-Small
3724028	3.0mm, Small
3724029	3.5mm, Large



### Lillie Ear Hook

Overall length 170mm (6¾")

Catalog #	Description
3724030	1mm Ball Tip



**E/Z Chuck Blade Handle  
TPE and Hardcoat Aluminum**

For use with Micro Otologic Knife Blades  
Holds Flat or Round Style Blades



Catalog #	Description
1352321	Overall length 105mm (4 1/4"), 6.3mm Diameter

**LiteTouch Uni-Handle  
Black Hardcoat Aluminum**

For use with Micro Otologic Knife Blades  
Holds Round Style Blades



Catalog #	Description
1352325	Overall length 117mm (4 5/8")

**Ear Knife Blade, Single-Use (Disposable)**

Catalog #	Description
1458230*	Micro ENT Blade, 4.0mm Up-Cutting. 5/Box
1458231*	Micro ENT Blade, 4.0mm Down-Cutting. 5/Box
1458232*	Micro ENT Blade, 4.0mm Straight-Cutting. 5/Box
1458233*	Micro ENT Blade, Spear Angled-Cutting. 5/Box
1458234*	Micro ENT Blade, Spear Straight-Cutting. 5/Box
1458275	Myringotomy Blade, Narrow 71N, 5/Box
1458276	Myringotomy Blade, Spear 71S, 5/Box

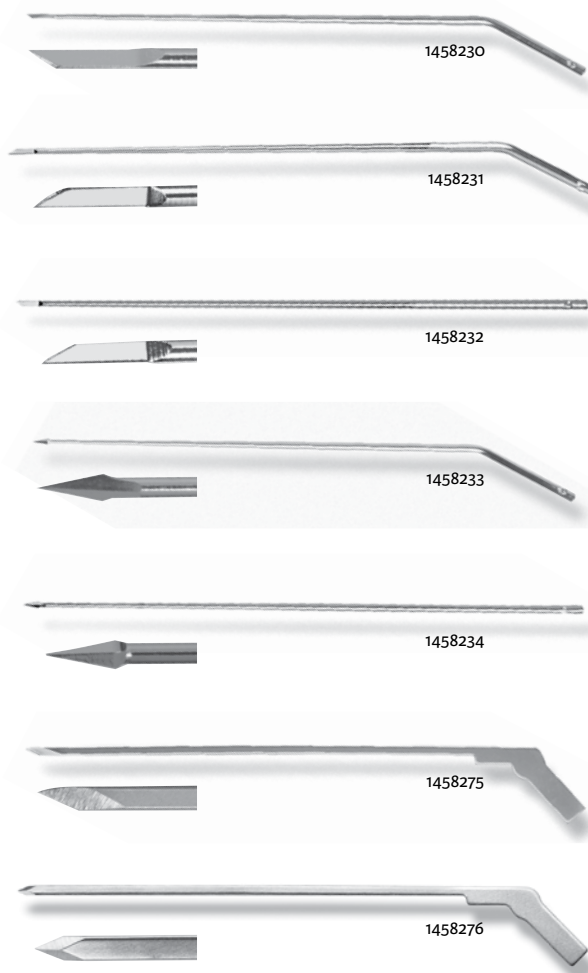

\*For use with 1352325, LiteTouch Uni-Handle only

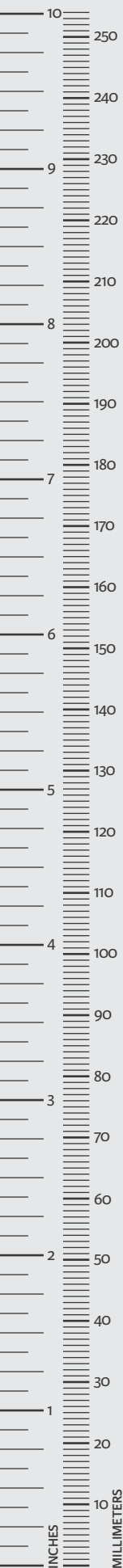

**Miringotomy Knife Blade (Disposable)**

Catalog #	Description
1411000	Spear Tip, 10/Pkg
1411050	Lancet Tip, 10/Pkg



**Miringotomy Knife**

Overall length 165mm (6½")

Catalog #	Description
3724282	8.0mm, Straight



**Royce Ear Knife, Angled**

Working length 86mm (3⅜")

Catalog #	Description
3724281	8.0mm, Down-Cutting



**Royce Ear Knife, Bayonet**

Overall length 190mm (7½")

Catalog #	Description
3724376	7.0mm, Up-Cutting
3724279	8.0mm, Down-Cutting



## LOOPS

### Billeau Ear Loop

Overall length 160mm (6¼")

Catalog #	Description
3724055	2.0mm, Small Oval Loop
3724056	3.0mm, Medium Oval Loop
3724057	4.0mm, Large Oval Loop



### House Billeau Ear Loop

Overall length 163mm (6½")

Catalog #	Description
3724058	3.5mm, Oval Loop



## NEEDLES

### Needle, Sharp Point

Catalog #	Description
3722164	Overall length 167mm (6½")



**Heiss Automatic Skin Retractor**

Overall length 102mm (4"), Cross-Action

Catalog #	Description
3724252	4 x 4 Sharp Prongs



**Bellucci-Wullstein Retractor**

Overall length 110mm (4 3/8")

Catalog #	Description
3724069	2-Blunt Prongs Right, Solid Blade Left
3724070	2-Blunt Prongs Left, Solid Blade Right



3724070

**J. House Vascular Strip Retractor**

Overall length 165mm (6 1/2")

Catalog #	Description
1352247	3-Blunt Prongs Right, 7 Pin Blade Left
1352248	3-Blunt Prongs Left, 7 Pin Blade Right



1352247

**Paparella-Weitlaner Retractor**

Overall length 140mm (5 1/2")

Catalog #	Description
3724068	2 x 2 Semi-Sharp Prongs



### Perkins Retractor

Overall length 130mm (5 1/8")

Catalog #	Description
3724066	3-Blunt Prongs Right, Solid Blade Left
3724067	3-Blunt Prongs Left, Solid Blade Right



3724066

### Schuknecht-Weitlaner Retractor

Overall length 130mm (5 1/8")

Catalog #	Description
3724072	3 x 3 Sharp Prongs



### Weitlaner Retractor

Overall length 130mm (5 1/8")

Catalog #	Description
3724332	Mastoid Retractor, 128.0mm (5")
3724333	Mastoid Retractor, 160.0mm (6 1/4")
3724240	2 x 3 Sharp Prongs, 108.0mm (4 1/4")
3724241	2 x 3 Blunt Prongs, 108.0mm (4 1/4")
3724242	3 x 4 Sharp Prongs, 135.0mm (5 3/8")
3724243	3 x 4 Blunt Prongs, 135.0mm (5 3/8")
3724244	3 x 4 Sharp Prongs, 170.0mm (6 3/4")
3724245	3 x 4 Blunt Prongs, 170.0mm (6 3/4")
3724247	3 x 4 Sharp Prongs, 205.0mm (8")



3724240

### Wullstein-Weitlaner Retractor

Overall length 132mm (5 1/4")

Catalog #	Description
3724071	3 x 3 Sharp Prongs, 108mm (4 1/4")
3724073	3 x 3 Semi-Sharp Prongs, 108mm (4 1/4")



3724071

**Beyer Rongeur**

Overall length 180mm (7"), Single-Action

Catalog #	Description
3712008	16.0mm, Curved



**Mini Friedman Rongeur**

Overall length 140mm (5½"), Single-Action

Catalog #	Description
3712200	1.2 x 6.0mm, Straight
3712201	1.5 x 6.0mm, Curved



3712200

**Kerrison Mastoid Rongeur**

Working length 100mm (3¾")

Catalog #	Description
3724074	No. 0, 3.5mm Bite
3712015	No. 1, 4.0mm Bite
3712016	No. 2, 4.5mm Bite
3712017	No. 3, 5.0mm Bite



3712015

**Lempert Rongeur, Heavy Pattern**

Overall length 190mm (7½"), Single-Action

Catalog #	Description
3712002	3.5 x 9.0mm, Straight
3712003	3.5 x 9.0mm, Curved



**Ruskin Rongeur**

Overall length 182mm (7"), Double-Action

Catalog #	Description
3712210	5.0mm, Straight
3712211	5.0mm, Curved





**Bellucci Scissors, Miniature, Fine**

Working length 87mm (3<sup>3</sup>/<sub>8</sub>" )

Catalog #	Description
3723001	8.0mm, Straight
3724309	8.0mm, Curved Left
3724310	8.0mm, Curved Right



**Bellucci Scissors, Very Fine**

Working length 82mm (3<sup>1</sup>/<sub>4</sub>" )

Catalog #	Description
3723008	4.5mm, Straight



**Bellucci Scissors, Micro, Black Finish**

Working length 80mm (3<sup>1</sup>/<sub>8</sub>" )

Catalog #	Description
3724312	3.0mm, Straight



**Fisch Crura Scissors**

Working length 75mm (3" )

Catalog #	Description
3723005	Angled Left
3723006	Angled Right



### House-Bellucci Alligator Scissors, Delicate

Working length 76mm (3")

Catalog #	Description
3724083	5.0mm, Straight
3724084	5.0mm, Curved Left
3724085	5.0mm, Curved Right
3724311	5.0mm, Angled Up 60°



### House-Dieters Malleus Nipper

Working length 82mm (3¼")

Catalog #	Description
3721045	0.9 x 2.0mm, Delicate
3721046	0.9 x 1.7mm, Extra Delicate



### Boucheron Specula, Round

Catalog #	Description
3724450**	Set of 8

*Set includes:*

3724093	Size 1, 3.0mm
3724094	Size 2, 3.5mm
3724095	Size 3, 4.5mm
3724096	Size 4, 5.0mm
3724097	Size 5, 5.5mm
3724098	Size 6, 6.5mm
3724099	Size 7, 7.5mm
3724100	Size 8, 9.0mm

\*\*Not for sale outside US

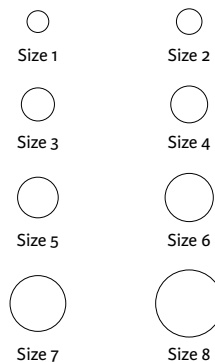

### Farrior Specula, Round

Catalog #	Description
3724460**	Set of 7

*Set includes:*

3724101	Size 1, 5.0mm
3724102	Size 2, 6.0mm
3724103	Size 3, 7.0mm
3724104	Size 4, 8.0mm
3724105	Size 5, 9.0mm
3724106	Size 6, 10.0mm
3724107	Size 7, 10.5mm

\*\*Not for sale outside US

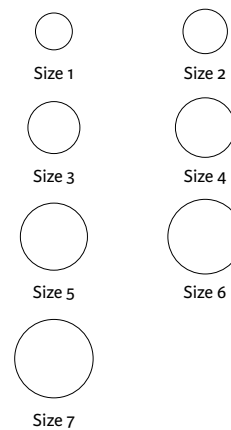

### Farrior Specula, Oval

Catalog #	Description
3724470**	Set of 7

*Set includes:*

3724108	Size 1, 4.5 x 5.5mm
3724109	Size 2, 5.5 x 6.5mm
3724110	Size 3, 6.5 x 7.5mm
3724111	Size 4, 7.5 x 8.5mm
3724112	Size 5, 8.0 x 10.0mm
3724113	Size 6, 9.0 x 11.0mm
3724114	Size 7, 10.0 x 12.0mm

\*\*Not for sale outside US



3724108

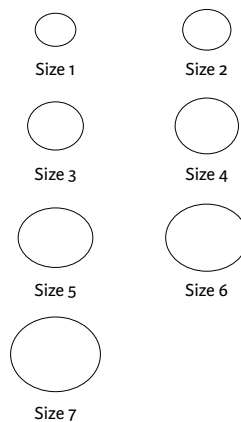

### Farrior Specula, Oval Oblique

Catalog #	Description
3724490**	Set of 7

*Set includes:*

3724122	Size 1, 5.0 x 6.0mm
3724123	Size 2, 6.0 x 7.0mm
3724124	Size 3, 7.0 x 8.0mm
3724125	Size 4, 8.0 x 10.0mm
3724126	Size 5, 9.0 x 11.0mm
3724127	Size 6, 10.0 x 12.0mm
3724128	Size 7, 11.0 x 13.0mm

\*\*Not for sale outside US



3724123

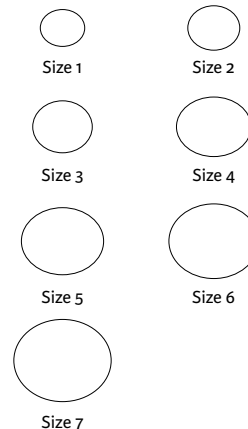

### Gruber Specula, Round

Catalog #	Description
3724152**	Set of 3

*Set includes:*

3724153	Size 1, 3.0mm
3724154	Size 2, 4.0mm
3724155	Size 3, 5.0mm

3724157 2.6mm, Infant

\*\*Not for sale outside US



3724157



### Gruber Specula, Oval

Catalog #	Description
3724158**	Set of 3

Set includes:

3724159	Size 1, 2.4 x 3.2mm
3724160	Size 2, 3.2 x 4.7mm
3724161	Size 3, 4.0 x 5.5mm

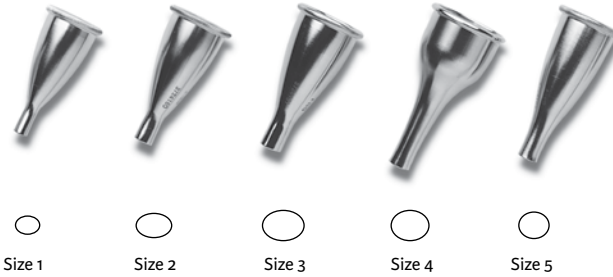

3724162	Size 4, 4.0 x 5.0mm
3724163	Size 5, 3.5 x 4.0mm

\*\*Not for sale outside US

### Hartman Specula, Round

Catalog #	Description
3724140**	Set of 4

Set includes:

3724141	Size 1, 4.0mm
3724142	Size 2, 5.0mm
3724143	Size 3, 6.0mm
3724144	Size 4, 7.0mm



3724150	2.5mm, Infant
---------	---------------

\*\*Not for sale outside US

### Hartman Specula, Oval

Catalog #	Description
3724149**	Set of 4

Set includes:

3724145	Size 1, 4.5 x 5.0mm
3724146	Size 2, 5.5 x 6.0mm
3724147	Size 3, 6.5 x 7.0mm
3724148	Size 4, 7.5 x 8.0mm



3724151	2.5 x 3.5mm, Infant
---------	---------------------

\*\*Not for sale outside US

### Toynee Speculum, Round

Catalog #	Description
3724138	2.0mm, Infant



### Ear Specula, Oval Oblique, Black Finish

Catalog #	Description
3724400**	Set of 11

*Set includes:*

3724401	Size 1, 3.0 x 4.0mm
3724402	Size 2, 3.5 x 4.5mm
3724403	Size 3, 4.0 x 5.0mm
3724404	Size 4, 4.5 x 5.5mm
3724405	Size 5, 5.0 x 6.0mm
3724406	Size 6, 5.5 x 6.5mm
3724407	Size 7, 6.0 x 7.0mm
3724408	Size 8, 6.5 x 7.5mm
3724409	Size 9, 7.0 x 8.0mm
3724410	Size 10, 7.5 x 8.5mm
3724411	Size 11, 8.0 x 9.0mm



3724407

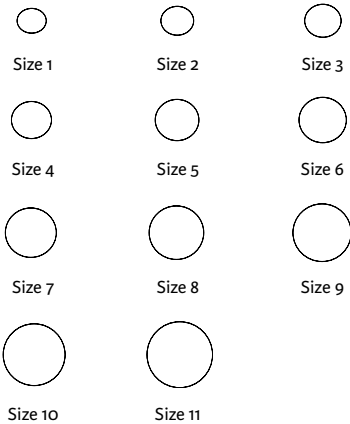

\*\*Not for sale outside US

### Universal Speculum Holder

Hands-free speculum holder

Designed to hold specula of varying sizes (speculum not included)

Holder stem fits into operating table sliding bar clamp

Completely adjustable and flexible until locked in semi-rigid position

Catalog #	Description
1362279**	Universal Speculum Holder Set

*Set includes:*

1362275	Universal Flexible Arm, 206mm (8 1/8")
1352282	Table Bracket Blade
1352277	Quik-Lock Speculum Mount

\*\*Not for sale outside US



1362279

### Shea Speculum Holder

Catalog #	Description
3724316	270.0mm Normal, 340.0mm Fully Extended



### Worktable Set

Set consist of 1352285, 1352286 and 1352287

Catalog #	Description
1352020**	

\*\*Not for sale outside US

### Hubbard Worktable W/Bracket

Catalog #	Description
1352285	6" L x 3 1/2" W x 1/2" D



### Worktable Piston Trimming Gauge

Catalog #	Description
1352286	Gauge Calibrated in .25mm Increments

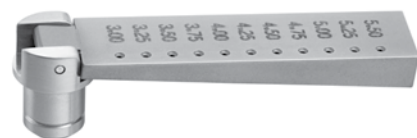

### Worktable Ossicle Holding Clamp

Catalog #	Description
1352287	Ossicle Holding Clamp



### Suction Handle W/Bypass Control (Disposable)

For use with Luer-Tipped Suction Needle

Catalog #	Description
1358270	6.3mm Suction Handle, 105mm (4 1/8"), 10/Pkg



### MicroLite Suction Needles (Disposable)

Includes plastic luer adapter without bypass

Suction handle with bypass (1358270) may be used

Malleable

Catalog #	Description
1359254	14 Gauge, Red, 10/Pkg
1359256	16 Gauge, Yellow, 10/Pkg
1359258	18 Gauge, Black, 10/Pkg
1359260	20 Gauge, Green, 10/Pkg
1359262	22 Gauge, Clear, 10/Pkg
1359264	24 Gauge, Blue, 10/Pkg



1359262

### Barnes Suction Tube

Catalog #	Description
3724183	4 French, 120mm (4 3/4")
3724184	5 French, 120mm (4 3/4")
3724185	6 French, 120mm (4 3/4")
3724188	9 French, 170mm (6 3/4")



3724185

### Baron Suction Tube

Working length 75mm (3")

Catalog #	Description
3724172	3 French
3724173	5 French
3724175	7 French



3724175



### Bellucci Suction Tube

Working length 70mm (2¾")

Catalog #	Description
3724189	Complete with 3 Tips, 18, 20, 22GA
3724190	18 Gauge Tip Only
3724191	20 Gauge Tip Only
3724193	22 Gauge Tip Only
3724194	24 Gauge Tip Only
3724196	Suction Cannula Only, 155.0mm (6")



### Brackman Suction Tube

Catalog #	Description
3724186	5 French, 80mm (3¼")
3724187	7 French, 70mm (2¾")



### Ferguson-Frazier Suction Tube, Angled

Working length 150mm (5⅞")

Catalog #	Description
3714259	6 French
3714260	7 French
3714261	8 French
3714262	9 French
3714263	10 French
3714264	12 French
3714265	14 French



### Ferguson-Frazier Suction Tube, Strong Angle

Working length 102mm (4")

Catalog #	Description
3714250	5 French
3714251	6 French
3714252	7 French
3714253	8 French
3714254	9 French
3714255	10 French
3714256	11 French
3714257	12 French
3714258	14 French
3714000S	Replacement Stylet, 6 French



### Frazier Suction Tube

Working length 102mm (4")

Catalog #	Description
3714000	6 French
3714001	7 French
3714002	8 French
3714003	9 French
3714004	10 French
3714005	11 French
3714006	12 French
3714007	14 French
3714000S	Replacement Stylet, 6 French



3714002

### Guilford-Wright Suction Tube

Overall length 98mm (3 7/8")

Catalog #	Description
3724213	20 Gauge, 0.90 O.D.
3724214	22 Gauge, 0.70 O.D.
3724215	24 Gauge, 0.50 O.D.



3724214

### House Cutoff Suction Adapter

Catalog #	Description
3724216	Overall length 54mm (2 1/8")



### House Suction Irrigator

Catalog #	Description
3724217	2.0 x 2.5mm French, 90.0mm (3½")
3724218	2.5 x 4.0mm French, 70.0mm (2¾")
3724219	2.5 x 4.0mm French, 90.0mm (3½")
3724220	4.0 x 5.0mm French, 70.0mm (2¾")
3724221	4.0 x 5.0mm French, 90.0mm (3½")
3724222	5.0 x 7.0mm French, 90.0mm (3½")
3724223	6.0 x 8.0mm French, 90.0mm (3½")
3724224	7.0 x 10.0mm French, 90.0mm (3½")
3724225	8.0 x 12.0mm French, 90.0mm (3½")
3724226	12.0 x 14.0mm French, 90.0mm (3½")



3724224

### House-Baron Suction Tube

Catalog #	Description
3724177	3 French, 100.0mm (3⅞")
3724178	5 French, 100.0mm (3⅞")
3724179	7 French, 100.0mm (3⅞")
3724181	5 French, 110.0mm (4⅜")
3724182	7 French, 110.0mm (4⅜")



3724182

### Kahn-Frazier Suction Tube

Working length 140mm (5½"), Malleable

Catalog #	Description
3714049	No. 1, 10 French
3714050	No. 2, 9 French



3714050

### McGee Suction Tube

Working length 70mm (2¾")

Catalog #	Description
3724420	22 Gauge, 0.70mm O.D.
3724421	24 Gauge, 0.60mm O.D.
3724422	26 Gauge, 0.50mm O.D.



3724420

### Rosen Suction Tube

Working length 60mm (2<sup>3</sup>/<sub>8</sub>" )

Catalog #	Description
3724199	14 Gauge, 2.0mm O.D.
3724200	15 Gauge, 1.8mm O.D.
3724201	16 Gauge, 1.5mm O.D.
3724203	18 Gauge, 1.2mm O.D.
3724205	20 Gauge, 0.9mm O.D.
3724206	22 Gauge, 0.7mm O.D.
3724207	24 Gauge, 0.6mm O.D.



3724203

### Schuknecht Suction Tube

Working length 73mm (2<sup>7</sup>/<sub>8</sub>" )

Catalog #	Description
3724209	20 Gauge, 0.9mm O.D.
3724210	22 Gauge, 0.7mm O.D.
3724211	24 Gauge, 0.55mm O.D.



3724211



### Myringotomy Instrument Set

Choose a blade handle 1352321 or 1352325 and blades to complete the set (sold separately)

Catalog #	Description
3754010**	Myringotomy Instrument Set of 11

*Set includes:*

- 3721026 House Mini Forceps, 4.5mm, Delicate Serrated Jaws
- 3724013 Buck Ear Curette, Angled, Dull, Size 1, 2.0mm
- 3724055 Billeau Ear Loop, Small, 2.0mm Loop
- 3722058 Barbara Pick, Straight Point, Malleable Shaft
- 3724401 Ear Speculum, Oval Oblique, Size 1, 3.0 x 4.0mm, Black
- 3724403 Ear Speculum, Oval Oblique, Size 3, 4.0 x 5.0mm, Black
- 3724405 Ear Speculum, Oval Oblique, Size 5, 5.0 x 6.0mm, Black
- 3724172 Baron Suction Tube, 75mm Working length, 3FR
- 3724173 Baron Suction Tube, 75mm Working length, 5FR
- 3724175 Baron Suction Tube, 75mm Working length, 7FR
- MCEN136SC Instrument Tray, 285mm L x 175mm W x 50mm D (11¼" L x 7" W x 2" D)

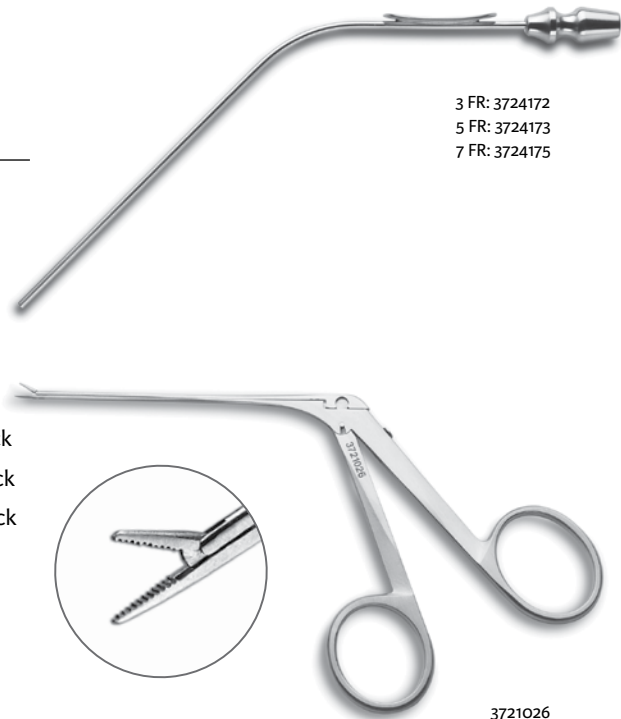

3 FR: 3724172  
5 FR: 3724173  
7 FR: 3724175

3721026

\*\*Not for sale outside US



3724013



3724055



3722058



3724401	3724403	3724405
3 x 4mm	4 x 5mm	5 x 6mm

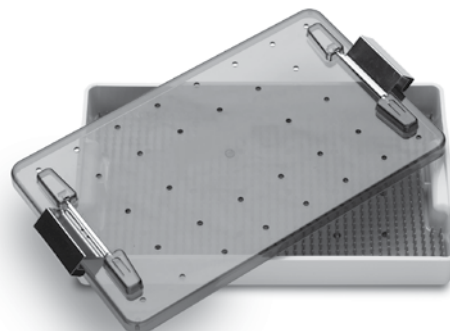

MCEN136SC

**AUSTIN INSTRUMENTS**

**Austin Duckbill Knife Elevator**

Overall length 165mm (6½")



Catalog #	Description
3724283	2.0mm, Curved Tip

**Austin Knife Elevator**

Overall length 164mm (6½")



Catalog #	Description
3724284	2.0mm, 90° Right Angle

**Austin Attic Dissector**

Overall length 158mm (6¼")



Catalog #	Description
3722000	5.0mm, Flat Tip, 90° Right Angle

**Austin Excavator**

Overall length 164mm (6½")



Catalog #	Description
3722001	0.75mm, Angled Left
3722002	0.75mm, Angled Right

3722002

**Austin Needle Pick**

Overall length 163mm (6½")



Catalog #	Description
3722003	Slightly Curved

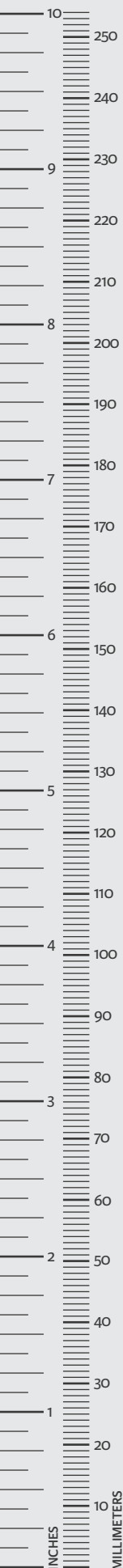

**AUSTIN INSTRUMENTS**

**Austin Pick**

Overall length 162mm (6½")



Catalog #	Description
3722004	1.0mm, Sharp, Angled 25°
3722005	1.0mm, Sharp, Angled 45°
3722006	1.0mm, Sharp, Angled 90°

3722005

**Austin Sickle Knife**

Overall length 160mm (6¼")



Catalog #	Description
3722008	3.0mm, Curved Blade

**Austin Chisel**

Overall length 165mm (6½")



Catalog #	Description
3722009	0.6mm, Straight

**Austin Footplate Elevator**

Overall length 160mm (6¼")



Catalog #	Description
3722010	0.4mm, 90° Right Angled

**Austin Footplate Hook**

Overall length 162mm (6½")



Catalog #	Description
3722011	0.33mm, 90° Right Angled
3722012	0.50mm, 90° Right Angled

3722011

**Austin Strut Caliper**

Overall length 163mm (6½")



Catalog #	Description
3722013	3.5mm, 4.0mm Groove, 5.0mm From Tip

## GUILFORD-WRIGHT INSTRUMENTS

### Guilford-Wright Duckbill Elevator

Overall length 155mm (6")



3722014

Catalog #	Description
3722014	3.0mm, Curved
3722015	2.0mm, Curved

### Guilford-Wright Drum Elevator

Overall length 165mm (6½")



Catalog #	Description
3722016	2.0 x 15.0mm, Angled 15°

### Guilford-Wright Footplate Pick

Overall length 165mm (6½")



3722020

Catalog #	Description
3722020	0.5mm, Angled 45°
3722021	0.5mm, Angled 90°

### Guilford-Wright Flap Knife

Overall length 165.0mm (6½")



Catalog #	Description
3722022	2.0 x 5.0mm Blade

### Guilford-Wright Sickle Knife

Overall length 155mm (6")



Catalog #	Description
3722023	5.0mm, Double-Edge, Curved

### Guilford-Wright Stapes Pick

Overall length 160mm (6¼")



Catalog #	Description
3722024	1.0mm, Blunt, 90° Right Angled



**HOUGH INSTRUMENTS**

**Hough Whirlybird Knife**

Overall length 155mm (6 1/8")



Catalog #	Description
3722026	No. 00, 1.0 x 5.0mm, Strong Curve, Right
3722027	No. 0, 1.0 x 5.0mm, Strong Curve, Left
3722028	No. 1, 0.75 x 5.0mm, Light Curve, Right
3722029	No. 2, 0.75 x 5.0mm, Light Curve, Left

**Hough Needle**

Overall length 165mm (6 1/2")



Catalog #	Description
3724285	Straight, Sharp Tip

**Hough Stapedectomy Pick**

Overall length 165mm (6 1/2")



Catalog #	Description
3724287	0.33mm, Angled 45°
3722030	0.33mm, Angled 90°

**Hough Footplate Pick**

Overall length 160mm (6 1/4")



Catalog #	Description
3724289	Slight Curve, Fine

**Hough Excavator**

Overall length 150mm (5 7/8")



Catalog #	Description
3724290	0.5mm Tip, Angled 45°
3724291	0.5mm Tip, Angled 90°

## HOUGH INSTRUMENTS

### Hough Curette

Overall length 145mm (5¾")

Catalog #	Description
3724292	2.5mm x 3.0mm, Serrated Cup, Angled 35°



### Hough Knife, "Small Weapon"

Overall length 165mm (6½")

Catalog #	Description
3722031	2.0mm Blade, Angled 45°



### Hough Drum Scraper

Overall length 150mm (5⅞"), Angled Shaft 15°

Catalog #	Description
3722032	1.0mm Point, Angled 45° 2.5mm Tip, Angled 60°



### Hough Pick

Overall length 165mm (6½")

Catalog #	Description
3722035	0.6mm Tip, Angled 90°



### Hough Stapedial Footplate Auger

Overall length 148mm (5⅞"), 15mm Fluted length

Catalog #	Description
3722033	0.8mm Diameter Drill
3722034	0.6mm Diameter Drill



3722033

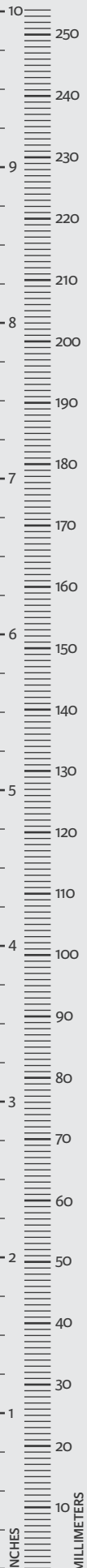

**Hough-Saunders Stapes Hoe**

Overall length 165mm (6½")

Catalog #	Description
3722103	1.0mm, 90° Right Angled



**HOUSE INSTRUMENTS**

**House Barbara Pick**

Overall length 155mm (6"), Malleable

Catalog #	Description
3722058	Straight Point



**House Currettes**

Overall length 178mm (7"), Double-Ended

Catalog #	Description
3722049	1.1 x 1.3mm, Light Angle
3722050	1.1 x 1.3mm, Strong Angle
3722051	2.2 x 2.5mm, Light Angle
3722052	2.2 x 2.5mm, Strong Angle



3722051

**House Crabtree Dissector Pick**

Overall length 165mm (6½")

Catalog #	Description
3722071	0.5 x 2.5mm, Large, Angled 90°
3722072	0.5 x 1.5mm, Small, Angled 90°



3722071

### House Elevator “Gimmick”

Overall length 160mm (6¼")

Catalog #	Description
3722048	1.0 x 12.0mm, Angled 15°



### House Footplate Chisel

Overall length 165mm (6½")

Catalog #	Description
3722073	0.6mm, Straight



### House Hook

Overall length 160mm (6¼"), Angled Shaft 15°

Catalog #	Description
3722069	1.0mm, Blunt Tip, Angled Left 90°
3722070	1.0mm, Blunt Tip, Angled Right 90°



### House Excavator

Overall length 160mm (6¼")

Catalog #	Description
3722065	0.33mm, Blunt Tip, Angled 90°



### House Incudostapedial Joint Knife

Overall length 155mm (6"), Malleable

Catalog #	Description
3722041	0.75mm, Angled 60°, 150mm (5⅞")
3722042	0.5 x 1.5mm, Angled 20°, 170mm (6¾")



### House Lancet Knife “#2 Knife”

Overall length 152mm (6")

Catalog #	Description
3722037	2.0 x 3.0mm, Tapered, Angled 45°

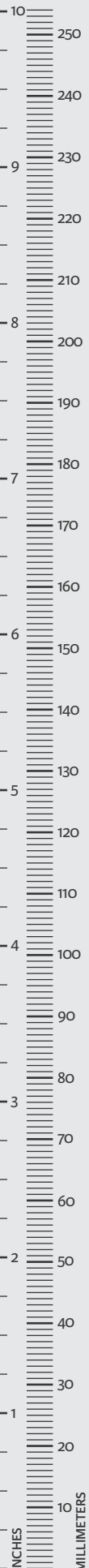

## HOUSE INSTRUMENTS

---

### House Strut Calipers

Overall length 165mm (6½"), Malleable Shaft

Catalog #	Description
3722077	3.5 mm from Marker to Tip
3722078	4.0 mm from Marker to Tip
3722079	4.5 mm from Marker to Tip
3722080	5.0 mm from Marker to Tip



### House Middle Ear Mirror

Overall length 160mm (6¼")

Catalog #	Description
3722076	2.5mm, Angled 45°



### House Myringotomy Knife

Overall length 158mm (6¼")

Catalog #	Description
3722043	0.6mm, Straight



### House Needle

Overall length 155mm (6")

Catalog #	Description
3722054	Sharp, Strong Short Curve
3722055	Sharp, Light Curve
3722056	Blunt, Light Curve
3722057	Semi-Sharp, Strong Curve



## HOUSE INSTRUMENTS

### House Oval Window Pick

Overall length 160mm (6¼"), Fine Shaft

Catalog #	Description
3722059	0.33mm Point, Angled 30°
3722060	0.33mm Point, Angled 90°
3722061	0.66mm Point, Angled 90°
3722063	0.66mm Point, Angled 30°



### House Pick

Overall length 160mm (6¼"), Heavy Shaft

Catalog #	Description
3722066	1.0mm, 90° Right Angled
3722067	1.5mm, 90° Right Angled
3722068	3.0mm, 90° Right Angled



### House Separator

Overall length 165mm (6½"), Bayonet

Catalog #	Description
3722046	1.5mm, Curved Blade
3722047	1.25mm, Curved Blade



### House Sheehy Knife Curette

Overall length 165mm (6½")

Catalog #	Description
3722038	2.0mm, Semi-Sharp Blade, "Small Weapon"
3722039	2.5mm, Semi-Sharp Blade, "Large Weapon"



### House Sickle Knife "Number One Knife"

Overall length 165mm (6½")

Catalog #	Description
3722036	7.5mm Curved Blade

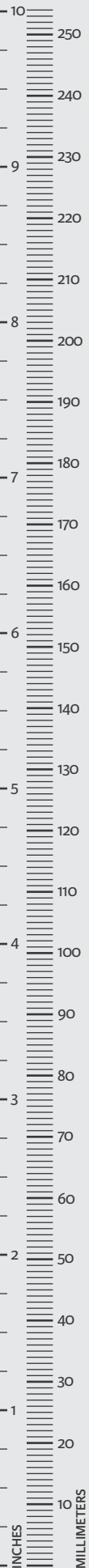

**HOUSE INSTRUMENTS**

**House Stapes Curette**

Overall length 153mm (6"), Double-Ended

Catalog #	Description
3722053	2.25 x 3.3mm and 2.0 x 2.8mm, Oval Cups



**House Strut Pick**

Overall length 160mm (6 1/4"), Medium Shaft

Catalog #	Description
3722062	0.50mm, 90° Right Angled
3722064	0.70mm, 90° Right Angled



**House Tympanoplasty Knife**

Overall length 165mm (6 1/2")

Catalog #	Description
3722040	7.0mm Curved Blade



**House Wire Strut Guide**

Overall length 165mm (6 1/2")

Catalog #	Description
3722075	0.6mm, Notched Tip



**JORDAN INSTRUMENTS**

**Jordan Stapedectomy Knife**

Overall length 165mm (6 1/2")

Catalog #	Description
3724293	2.0mm x 3.0mm, Tapered Blade, Angled 45°



## JORDAN INSTRUMENTS

### Jordan Needle

Working length 60mm (2<sup>7</sup>/<sub>8</sub>" ), Bayonet

Catalog #	Description
3724294	Heavy, Sharp



## KOS INSTRUMENTS

### KOS Needle

Working length 85mm (3<sup>3</sup>/<sub>8</sub>" ), Bayonet

Catalog #	Description
3724296	Sharp, Straight



## McCABE INSTRUMENTS

### McCabe Culbertson Canal Knife

Overall length 162mm (6<sup>1</sup>/<sub>2</sub>" )

Catalog #	Description
3722082	1.5 x 2.0mm Blade, Angled 45°



### McCabe Canal Knife

Overall length 165mm (6<sup>1</sup>/<sub>2</sub>" ), Sharp Blade

Catalog #	Description
3722083	2.0mm, Angled 45°
3722084	2.5mm, Angled 45°



### McCabe Flap Knife Dissector

Overall length 184mm (7<sup>1</sup>/<sub>4</sub>" ), Double-Ended

Catalog #	Description
3722085	2.0 x 3.0mm, Angled 25° and 45°





**McCABE INSTRUMENTS**

**McCabe Perforation Rasp**

Overall length 165mm (6½")

Catalog #	Description
3722086	4.0mm Blade, Angled 45°
3722087	4.0mm Blade, Angled 120°



**McCabe Facial Nerve Dissecting Forceps**

Overall length 140mm (5½")

Catalog #	Description
3722089	14.0mm Smooth Jaws, Angled 45°



**McGEE INSTRUMENTS**

**McGee Footplate Pick**

Overall length 162mm (6½"), Angled Shaft 15°

Catalog #	Description
3722090	1.0mm, Angled Up 90°
3722091	1.0mm, Angled Down 90°



**McGee Oval Window Rasp**

Overall length 162mm (6½"), Angled Shaft 15°

Catalog #	Description
3722092	0.4mm Diameter
3722093	0.7mm Diameter



**McHUGH INSTRUMENTS**

**McHugh Flap Knife**

Overall length 165mm (6½")

Catalog #	Description
3722088	3.0mm Round Blade



**PAPARELLA INSTRUMENTS**

**Paparella Duckbill Elevator**

Overall length 165mm (6½")

Catalog #	Description
3722115	3.5mm, Slight Curve, Sharp Blade



**Paparella Fenestrometer**

Overall length 165mm (6½")

Catalog #	Description
3722109	2.0 x 4.0mm Scale, 0.5mm Increments



**Paparella Fine Needle**

Overall length 165mm (6½")

Catalog #	Description
3722101	Sharp



**Paparella Heavy Needle**

Overall length 160mm (6¼")

Catalog #	Description
3722102	Sharp



**Paparella Incudostapedial Joint Knife**

Catalog #	Description
3722100	0.5 x 1.5mm, Angled 20°, 165mm (6½")

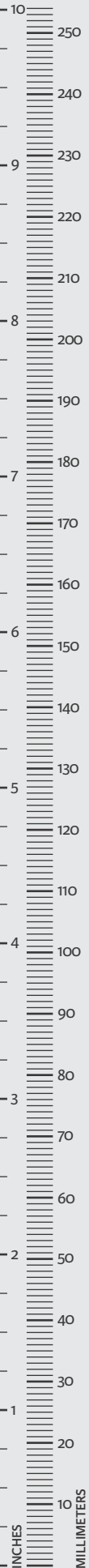

**PAPARELLA INSTRUMENTS**

**Paparella “Whirlybird” Pick**

Overall length 165mm (6½")

Catalog #	Description
3722113	1.0 x 4.0mm Blade, Right
3722114	1.0 x 4.0mm Blade, Left



**Paparella-Saunders Hook**

Overall length 165mm (6½"), Malleable Shaft

Catalog #	Description
3722106	#3, 0.75mm Hook, 90° Right Angled



**Paparella-Saunders Window Rasp and Marker**

Overall length 165mm (6½"), Malleable Shaft

Catalog #	Description
3722107	Marked at 4.0, 4.5, and 5.0mm



**Paparella Sickle Knife**

Overall length 165mm (6½")

Catalog #	Description
3722110	5.0mm Blade, Straight
3722111	5.0mm Blade, Curved Right
3722112	5.0mm Blade, Curved Left



## ROSEN INSTRUMENTS

### Rosen Pick

Overall length 160mm (6¼")

Catalog #	Description
3722117	3.0mm, Curved
3722118	1.5mm, Angled 45°



## SCHUKNECHT INSTRUMENTS

### Schuknecht Roller Knife

Overall length 155mm (6"), 15° Angled Shaft

Catalog #	Description
3722122	3.0mm, In-Line
3722123	3.0mm, 90° Right Angled



### Schuknecht Footplate Hook

Overall length 165mm (6½"), 15° Angled Shaft

Catalog #	Description
3722124	0.4mm Tip, Angled Up
3722125	0.7mm Tip, Angled Up
3722126	0.4mm Tip, Angled Down
3722127	0.7mm Tip, Angled Down



**SCHUKNECHT INSTRUMENTS**

**Schuknecht Whirlybird Excavator**

Overall length 165mm (6½"), Angled Shaft 15°

Catalog #	Description
3722128	0.75mm, Curved Left
3722129	0.75mm, Curved Right



**Schuknecht Hook**

Overall length 165mm (6½"), Angled Shaft 15°

Catalog #	Description
3722130	1.0mm Tip, 90° Right Angle
3722131	2.0mm Tip, 90° Right Angle



**Schuknecht Needle**

Overall length 165mm (6½"), Angled Shaft 15°

Catalog #	Description
3722132	Straight Tip



**Schuknecht Spatula**

Overall length 165mm (6½"), Angled Shaft 15°

Catalog #	Description
3722133	1.0mm Round Tip



**Schuknecht Sickle Knife**

Overall length 165mm (6½"), Angled Shaft 15°

Catalog #	Description
3722134	7.0mm Blade



## SHEA INSTRUMENTS

### Shea Incision Knife

Overall length 167mm (6½")

Catalog #	Description
3724305	1.5mm, Tapers to 0.25mm, Angled 45°



### Shea Curette

Overall length 142mm (5⅝")

Catalog #	Description
3722140	2.0mm Round Cup



### Shea Fenestration Hook

Overall length 165mm (6½")

Catalog #	Description
3722160	1.0mm Hook, Angled 45°



### Shea Oblique Hook

Overall length 165mm (6½")

Catalog #	Description
3722141	1.0mm, Blunt Hook, 90° Right Angled



### Shea Footplate Hook

Overall length 165mm (6½")

Catalog #	Description
3722142	1.0mm, 90° Right Angled



**TABB INSTRUMENTS**

---

**Tabb Prosthesis Placement Hook**

Overall length 165mm (6½")

Catalog #	Description
3722145	0.5mm Hook, Slightly Angled



**Tabb Long Backhanded Elevator**

Overall length 165mm (6½")

Catalog #	Description
3722147	1.5 x 2.0mm, Tapered, Angled 45°



## MISCELLANEOUS INSTRUMENTS

### Derlacki Mobilizer

Overall length 158mm (6¼"), Angled Tip 45°

Catalog #	Description
3722136	1.0mm, Round End Serrated



### Derlacki Chisel

Overall length 165mm (6½")

Catalog #	Description
3722154	0.5mm, Straight
3722155	0.5mm, Angled 10°



### Ghandi Knife

Overall length 165mm (6½")

Catalog #	Description
3722159	4.0mm, Curved, Delicate



### Harrison Knife

Overall length 159mm (6¼")

Catalog #	Description
3722158	1.8mm Blade, Angled 45°





### Myringoplasty Knife

Overall length 163mm (6½"), Double-Ended

Catalog #	Description
3722149	2.0mm Blades, Angled 90° and 120°
3722150	2.0mm Blades, Angled 90° and 115°
3722151	2.0mm Blades, Angled 25° and 45°



### Pick Knife

Overall length 165mm (6½")

Catalog #	Description
3722163	3.0mm, Sharp



### Flap Knife

Overall length 155mm (6"), Double-Ended

Catalog #	Description
3722152	2.0 x 4.0mm, Angled 45°, 3.0 x 4.0mm, Angled 20°



### Ear Syringe, Metal

Removable Shield and Tips

Catalog #	Description
3724318	50cc (1.5oz.)
3724395	100cc (3oz.)



### Ear Syringe Tip

Overall length 36mm (1 3/8")

Catalog #	Description
3724320	Bulbus Tip



### Goode T-Tube Forceps

Overall length 87mm (3 3/8")

Catalog #	Description
1316005	1.25 I.D. x 5.5mm Jaw



### House Cutting Block

Autoclavable

Catalog #	Description
3724064	78mm L x 37mm W x 8mm D (3 1/8" L x 1 1/2" W x 3/8" D)



### Cartilage and Fascia Press

Catalog #	Description
CP814-2	30.0 x 49mm
CP814-3	Key for Press



CP814-2

### House Gelfoam® Press

Catalog #	Description
3724062	16.0 x 12.0mm Plates, 191mm (7½")
3724063	16.0 x 12.0mm Plates, 135mm (5¾")



3724062

### Sheehy Fascia Press

Overall length 191mm (7½")

Catalog #	Description
3724061	23 x 31mm Plates



### Hartmann Tuning Forks

Catalog #	Description
3724231	C128, with Weights
3724232	C256, with Weights
3724233	C512, without Weights
3724234	C1024, without Weights
3724235	C2048, without Weights



3724231



3724234

### Otology Tray Set

3717025 features

Aluminum pick tray with silicone brackets holds up to 32 picks

Designed to fit inside aluminum Otology Tray, 3717026

Can be inverted to stand upright for easy identification and access

Each placeholder is numbered for identification

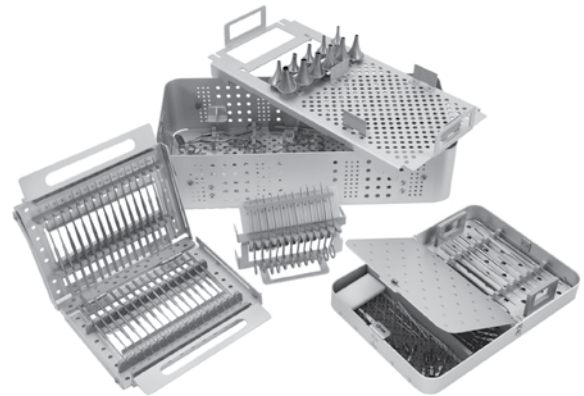

3717026 features

Multi-level, modular aluminum tray

Fits the House Otology Instrument Set and accommodates ear specula, forceps, retractors, suction, and curettes

Aluminum pick tray (3717025) fits inside this tray



3717025

Catalog #	Description
3717025	Pick Tray, 24.8cm L x 22.1cm W x 4.5cm D (9¾" L x 8¾" W x 1¾" D)

3717026	Ear Tray, 52.7cm L x 25.4cm W x 18.2cm D (20¾" L x 10" W x 7¼" D)
---------	--



3717026

### Three-Level Tray

Three-level modular tray includes silicone mats. Accommodates approximately 50 instruments, including nasal specula, mallets, osteotomes, forceps, and retractors

Catalog #	Description
3717011	52.8cm L x 25cm W x 12.3cm D (20¾" L x 9¾" W x 4⅞" D)



3717011

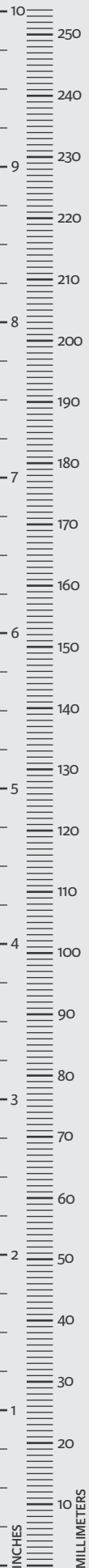

### Pick Tray

Plastic clamshell tray with silicone brackets holds up to 16 picks

Each placeholder is numbered for rapid identification

Catalog #	Description
3717022	Holds 16 Instruments, 21cm L x 12.3cm W x 3.6cm D (8¼" L x 4⅞" W x 1⅜" D)

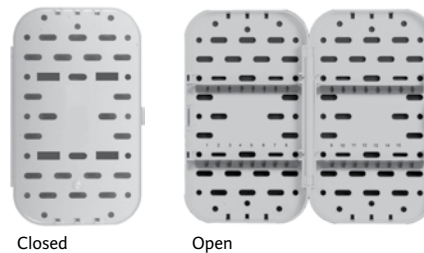

### Plastic Otology Tray

Both upper insert and base include silicone mats

Two 3717022 pick trays will fit inside base

Includes 6 silicone straps, 12 snap-in posts, and a post removal tool to stabilize ring-handled instruments

Catalog #	Description
MCOHoSC	54.6cm L x 25.9cm W x 12cm D (21½" L x 10¼" W x 4¾" D)

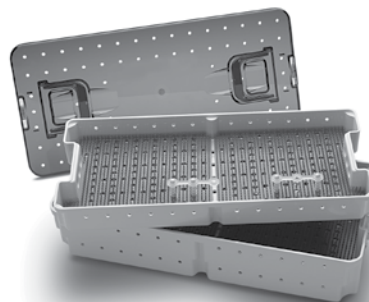

### Two-Level Tray

Both upper insert and base include silicone mats

One 3717022 pick tray will fit inside base

Deep enough to accommodate nasal specula, ear specula, or retractors

Large enough for a Myringotomy Set, Tonsil and Adenoid Set, or Lateral Skull Base Set

Catalog #	Description
MCOS1oSC	38.5cm L x 25.6cm W x 12.8cm D (15¼" L x 10" W x 5" D)

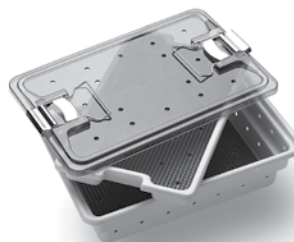



INTEGRA<sup>®</sup>  
LIMIT UNCERTAINTY



Integra<sup>®</sup>  
ENT Instrumentation  
Nasal and Sinus Instruments



### Farrell Applicator

Overall length 140mm (5½")

Catalog #	Description
3714008	1.4 x 20.0mm, Roughened End
3714009	1.2 x 20.0mm, Triangular End



### Lathbury Applicator

Overall length 140mm (5½")

Catalog #	Description
3714010	1.2 x 20.0mm, Roughened End
3714011	1.0 x 15.0mm, Triangular End





### Ballenger V-Shaped Chisel

Overall length 150mm (5<sup>7</sup>/<sub>8</sub>" )

Catalog #	Description
3714055	2.0mm
3714056	4.0mm
3714057	6.0mm
3714058	8.0mm



### Converse Guarded Chisel

Overall length 195mm (7<sup>3</sup>/<sub>4</sub>" )

Catalog #	Description
3714087	6.0mm, Curved Right
3714088	6.0mm, Curved Left



### Cottle Chisel

Overall length 185mm (7<sup>1</sup>/<sub>4</sub>" )  
Depth Markings at 20, 30, 40 and 50mm

Catalog #	Description
3714086	6.0mm, Curved



### Freer Chisel

Overall length 160mm (6<sup>1</sup>/<sub>4</sub>" )

Catalog #	Description
3714053	4.0mm, Straight



### Metzenbaum Chisel

Overall length 148mm (5<sup>7</sup>/<sub>8</sub>" )

Catalog #	Description
3714320	5.0mm Cutting Edge



**Antrum Curette**

Overall length 196mm (7¾")

Catalog #	Description
3714223	2.5 x 6.0mm, Oblong Cup



**Antrum Curette**

Overall length 195mm (7¾")

Catalog #	Description
3714224	4.0 x 10.0mm, Oblong Cup



**Antrum Curette**

Overall length 193mm (7½")

Catalog #	Description
3714222	5.0mm Round Cup



**Antrum Curette**

Overall length 193mm (7½")

Catalog #	Description
3714221	7.0 x 10.0mm, Oblong Cup



**Antrum Curette**

Overall length 193mm (7½")

Catalog #	Description
3714225	8.0 x 11.0mm, Oblong Cup



**Antrum Curette**

Overall length 195mm (7¾")

Catalog #	Description
3714226	9.0 x 13.0mm, Oblong Cup



### Coakley Sinus Curette, Backward

Overall length 191mm ( 7½")

Catalog #	Description
3714228	7.9 x 8.2mm, Oval Tip, Angled 45°



### Coakley Sinus Curette, Forward

Overall length 190mm ( 7½")

Catalog #	Description
3714227	7.9 x 8.2mm, Oval Tip, Angled 45°
3714317	5.6 x 7.2mm, Oval Tip, Angled 45°



3714227

### Coakley Antrum Currettes

Overall length 180mm (7"), Round Knurled Handle

Catalog #	Description
3714311	Large, 5.4 x 8.6mm, Angled 45°
3714313	Large, 4.75 x 8.0mm, Angled 110°
3714314	Small, 4.3 x 6.5mm, Angled 45°
3714315	Small, 4.3 x 6.5mm, Angled 50°
3714316	Small, 4.9 x 4.3mm, Triangle Tip, Angled 30°



3714315



### Frontal Sinus Curette

Oblong Cups

Catalog #	Description
3714703	2.5 x 6.0mm, Straight, 198mm (7¾")
3714229	2.5 x 6.0mm, Angled 45°, 192mm (7½")
3714284	3.5 x 7.75mm, Angled 75°, 187mm (7¼")
3714230	2.5 x 6.0mm, Angled 90°, 187mm (7¼")
3714285	3.5 x 7.75mm, Angled 100°, 187mm (7¼")



3714229

**Ball Elevator**

Overall length 190mm (7½"), Double-Ended

Catalog #	Description
3714118	2.5mm Ball Tips



**Boies Nasal Fracture Elevator**

Overall length 197mm (7¾")

Catalog #	Description
3714381	9.0mm, Wide Blade



**Cottle Septum Elevator**

Overall length 217mm (8½"), Double-Ended

Catalog #	Description
3714127	3.0 and 4.0mm Ends, Graduated 10.0mm Increments



**Cottle Skin Elevator**

Overall length 195mm (7¾")

Catalog #	Description
3714126	8.0mm, Curved Blade



**Dingman Periosteal Elevator**

Overall length 180mm (7"), Double-Ended

Catalog #	Description
3714660	6.0mm Curved-Up, 4.0mm Curved-Down



**Freer Septum Elevator**

Double-Ended

Catalog #	Description
3714038	4.5mm, Square Handle, 180mm (7")
3714039	6.5mm, Round Handle, 200mm (7¾")
3714372	4.5mm, Round Handle, 180mm (7")



3714038

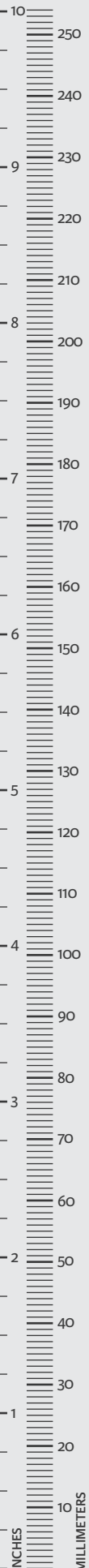

**Gillies Zygoma Elevator**

Overall length 229mm (9")



Catalog #	Description
3714379	7.5mm x 36.0mm Angled 10°

**Goldman Displacer Septum Elevator**

Overall length 200mm (7¾")



Catalog #	Description
3714382	6.0mm, Tapered Heavy Blade

**Gorney Septum Suction Elevator**

Overall length 220mm (8¾")



Catalog #	Description
3714383	3.0mm, Curved Tip

3714383 (shown with stylette)

**House Elevator**

Overall length 170mm (6¾")



Catalog #	Description
3714114	2.0mm, Narrow, Straight

**Joseph Periosteal Elevator**

Overall length 170mm (6¾")



Catalog #	Description
3714125	5.0mm, Curved Tapered Tip

**Lempert Elevator**

Overall length 160mm (6¼")



Catalog #	Description
3714115	2.0mm, Slightly Curved
3714116	3.0mm, Slightly Curved

3714115

### McCullough Elevator

Overall length 190mm (7½"), Double-Ended

Catalog #	Description
3714117	2.2mm, Semi-Sharp Round Blade, 2.5mm, Elevator Blade



### McKenty Periosteal Elevator

Overall length 147mm (5¾")

Catalog #	Description
3714123	4.0mm



### Pennington Elevator

Overall length 210mm (8¼"), Double-Ended

Catalog #	Description
3714119	6.0 x 12.8mm Blades



### Pierce Elevator

Overall length 210mm (8¼"), Double-Ended

Catalog #	Description
3714121	5.5mm Blades



### Woodson Elevator

Overall length 203mm (8"), Double-Ended

Catalog #	Description
3714040	2.4mm Angled 10° and 4.0mm Angled 30°



### Zygomatic Arch Elevator

Overall length 250mm (8¾")

Catalog #	Description
3747006	5.0 x 20.0mm, Curved Tip

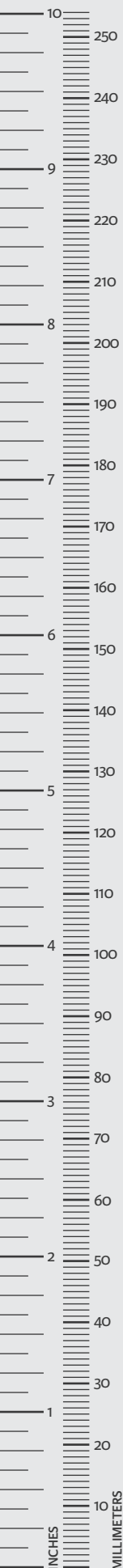

### Asch Septum Straightening Forceps

Overall length 225mm (8¾")

Catalog #	Description
3711028	5.5mm, Flat Blades, Angled 25°



### Biopsy and Grasping Forceps

Working length 90mm (3½"),  
Double-Action

Catalog #	Description
3711059	3.0 x 6.0mm Cups, Straight
3711129	3.0 x 6.0mm Cups, Angled 70°
3711130	3.0 x 6.0mm Cups, Angled 110°



### Biopsy and Grasping Forceps, Long

Working length 130mm (5⅛"),  
Double-Action

Catalog #	Description
3711049	3.0mm Cup, 70° Horizontal Shaft
3711050	3.0mm Cup, 110° Horizontal Shaft
3711055	4.0mm Cup, 70° Horizontal Shaft
3711056	4.0mm Cup, 110° Horizontal Shaft
3711051	3.0mm Cup, 110° Vertical Shaft
3711052	4.0mm Cup, 110° Vertical Shaft
3711053	3.0mm Cup, 70° Vertical Shaft
3711054	4.0mm Cup, 70° Vertical Shaft



### Blakesley Septum Forceps

Working length 115mm (4½")

Catalog #	Description
3711108	6.6 x 14.0mm, Straight, Serrated



### Blakesley Forceps, Thru-Cut

Working length 115mm (4½")

Catalog #	Description
3711079	2.0mm, Straight Jaw
3711080	2.5mm, Straight Jaw
3711081	3.0mm, Straight Jaw
3711084	2.0mm, Angled Up 45°
3711085	2.5mm, Angled Up 45°
3711086	3.0mm, Angled Up 45°
3711140	2.5mm, Angled Right
3711141	2.5mm, Angled Left



### Bruening Septum Forceps

Working length 110mm (4¾")

Catalog #	Description
3711110	7.5 x 9.0mm Fenestrated Jaws



### Cupped Sinus Forceps

Working length 115mm (4½")

Catalog #	Description
3711067	3.5mm Cups





### Giraffe Frontal Sinus Recess Forceps

Working length 130mm (5 1/8"), Double-Action

Catalog #	Description
3711060	2.0mm, 45° Vertical Jaws
3711061	2.0mm, 45° Horizontal Jaws
3711062	2.0mm, 90° Horizontal Jaws
3711063	2.0mm, 90° Vertical Jaws
3711064	3.0mm, 45° Vertical Jaws
3711065	3.0mm, 45° Horizontal Jaws



### Giraffe Frontal Sinus Recess Forceps, Thru-Cut

Working length 130mm (5 1/8"), Double-Action

Catalog #	Description
3712300	2.0mm, 110° Horizontal Jaws, Serrated
3712301	2.0mm, 110° Vertical Jaws, Serrated
3712310	2.0mm, 45° Vertical Jaws
3712311	2.0mm, 45° Horizontal Jaws
3712312	2.0mm, 90° Vertical Jaws
3712313	2.0mm, 90° Horizontal Jaws
3712314	3.0mm, 45° Vertical Jaws
3712315	3.0mm, 45° Horizontal Jaws

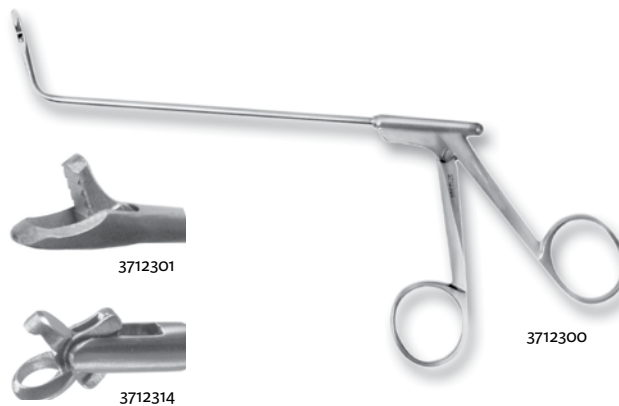

### Gruenwald Clean-Bite Forceps

Working length 130mm (5 1/8")

Catalog #	Description
3711082	Size oo, 2.0mm, Straight, Serrated
3711083	Size o, 2.5mm, Straight, Serrated
3711088	Size oo, 2.0mm, 45° Up, Serrated
3711089	Size o, 2.5mm, 45° Up, Serrated



### Gruenwald-Jansen Bayonet Forceps

Overall length 213mm (8½")

Catalog #	Description
3711100	20.0mm, Serrated Tip



### Gruenwald Nasal Bayonet Forceps

Overall length 203mm (8")

Catalog #	Description
3711007	2.0 x 18.0mm, Serrated Tip



### Gruenwald Nasal Forceps, Thru-Cut

Working length 115mm (4½")

Catalog #	Description
3711010	Size 1, 3.0 x 10.0mm
3711011	Size 2, 3.5 x 11.3mm
3711012	Size 3, 4.0 x 12.0mm



### Gruenwald Nasal Forceps, Modified Jaws

Working length 115mm (4½"), Thru-Cut Jaws

Catalog #	Description
3711013	3.5 x 10.5mm



**Heuwieser Antrum Grasping Forceps**

Working length 130mm (5 1/8")

Catalog #	Description
3711071	3.5mm, Curved Down 90°, Opens Back to 120°



**Hildyard Post-Nasal Biopsy Forceps**

Working length 120mm (4 3/4")

Catalog #	Description
3711066	3.5mm Cups



**Jansen-Middleton Septum Forceps**

Catalog #	Description
3711025	5.0 x 12.5mm, Spoon, 95mm (3 3/4")
3711026	4.6 x 15.0mm, Large, 105mm (4 1/8")
3711027	3.6 x 15.0mm, Small, 100mm (3 7/8")



**Lewis Septum Forceps**

Working length 115mm (4 1/2")

Catalog #	Description
3711022	11.5mm Grooved Jaws, Opens Left



### Lucae Nasal Dressing Bayonet Forceps

Catalog #	Description
3711002	1.25 x 16.5mm, 140mm (5½")
3711004	1.25 x 15.0mm, 140mm (5½")
3711005	2.0 x 17.5mm, 165mm (6½")



### Noyes Nasal Dressing Forceps

Overall length 165mm (6½")

Catalog #	Description
3711006	2.0 x 15.5mm



### MeroPack Insertion Forceps

Overall length 203mm (8"), Bayonet

Catalog #	Description
9511007	2.0 x 18.0mm, Smooth Tips



### Pear-Shaped Cupped Jaw Forceps

Working length 130mm (5⅛")

Catalog #	Description
3711068	6.0mm, Angled 45° Up, Horizontal Jaws
3711069	6.0mm, Angled 80° Up, Horizontal Jaws



### Punch Biopsy Forceps, Thru-Cut

Working length 130mm (5⅛")

Catalog #	Description
3711057	2.0mm, Angled Up 70°, Top Jaw Serrated

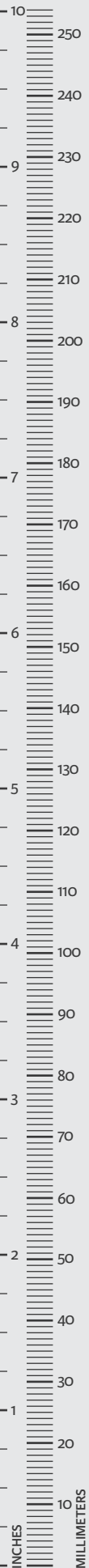

### Skinner Maxillary Biopsy Forceps

Working length 130mm (5 1/8"), Double-Action

Catalog #	Description
3711127	3.0mm Cups, Angled Down 70°, Vertical
3711128	3.0mm Cups, Angled Down 110°, Horizontal



3711128

### Strüempel Pediatric Forceps

Working length 105mm (4 1/8")

Catalog #	Description
3711035	2.4mm, Straight
3711036	2.4mm, Angled Up 45°
3711037	2.4mm, Angled Up 90°



3711036

### Strüempel-Voss Forceps

Working length 115mm (4 1/2")

Catalog #	Description
3711113	3.0mm, Straight
3711114	3.0mm, Angled Up 45°
3711115	3.0mm, Angled Up 90°



3711113

### Stryucken Turbinate Forceps

Working length 115mm (4 1/2")

Catalog #	Description
3711009	1.0 x 16.0mm, Serrated Jaws



### Takahashi Nasal Forceps

Working length 115mm (4½")

Catalog #	Description
3711109	2.5 x 12.0mm, Angled Up 30°
3711020	2.5 x 8.0mm, Straight
3711021	4.0 x 9.0mm, Straight



### Takahashi Nasal Forceps

Working length 178mm (7")

Catalog #	Description
3711017	2.0 x 10.0mm, Straight (Cushing)
3711018	3.0 x 10.0mm, Straight (Love-Greunwald)
3711019	4.0 x 10.0mm, Straight (Spurling)

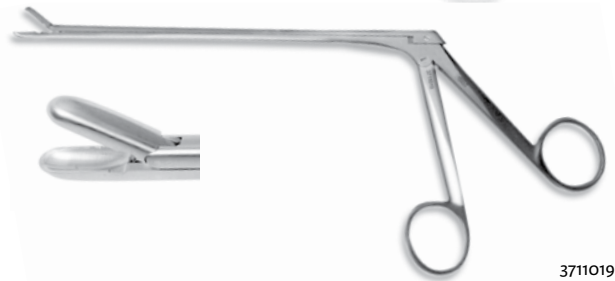

### Walsham Septum Straightening Forceps

Overall length 230mm (9")

Catalog #	Description
3711029	7.0 x 33.0mm, Straight, Narrow Blades



**Weil Nasal Forceps**

Working length 115mm (4½")

Catalog #	Description
3711014	5.0 x 8.5mm, Angled Up 45°



**Watson Williams Nasal Polyp Forceps**

Working length 115mm (4½")

Catalog #	Description
3711008	No. 1: 6.5 x 8.0mm, Straight Jaws
3711105	No. 2: 9.5 x 13.0mm, Straight Jaws



**Weil-Blakesley Sinus Forceps**

Working length 115mm (4½")

Catalog #	Description
3711038	Size oo, 3.0mm, Straight
3711043	Size o, 3.5mm, Straight
3711044	Size 1, 4.0mm, Straight
3711045	Size 2, 5.0mm, Straight
3711118	Size 3, 6.0mm, Straight



**Weil-Blakesley Sinus Forceps**

Working length 115mm (4½")

Catalog #	Description
3711039	Size oo, 3.0mm, Angled Up 45°
3711040	Size o, 3.5mm, Angled Up 45°
3711041	Size 1, 4.0mm, Angled Up 45°
3711042	Size 2, 5.0mm, Angled Up 45°
3711119	Size 3, 6.0mm, Angled Up 45°





### Weil-Blakesley Sinus Forceps

Working length 115mm (4½")

Catalog #	Description
3711047	Size 0, 3.5mm, Angled Up 90°
3711048	Size 1, 4.0mm, Angled Up 90°
3711046	Size 2, 5.0mm, Angled Up 90°



3711047

### Weil-Blakesley Forceps, Thru-Cut

Working length 115mm (4½")

Catalog #	Description
3711200	2.0mm, Straight
3711201	2.5mm, Straight
3711202	3.0mm, Straight
3711203	2.0mm, Angled 45° Up
3711204	2.5mm, Angled 45° Up
3711205	3.0mm, Angled 45° Up
3711210	2.5mm, Angled Right
3711213	2.5mm, Angled Left



3711200

3711203

### Wilde Dressing Forceps, Delicate

Working length 115mm (4½")

Catalog #	Description
3711102	1.9 x 16.0mm Serrated, 121mm (4¾")
3711103	1.9 x 14.0mm Serrated, 145mm (5¾")



3711103



**Blakesley Nasal Suction Forceps, Thru-Cut**

Working length 100mm (3 7/8")

Catalog #	Description
3711142	Size oo, 2.0mm, Straight
3711143	Size o, 2.5mm, Straight
3711145	Size oo, 2.0mm, Angled Up 45°
3711146	Size o, 2.5mm, Angled Up 45°



**Strüempel-Lusk Nasal Suction Forceps, Pediatric**

Working length 100mm (3 7/8")

Catalog #	Description
3711116	2.5mm, Straight
3711117	2.5mm, Angled Up 30°



**Weil-Blakesley Nasal Suction Forceps**

Working length 100mm (3 7/8")

Catalog #	Description
3711121	Size oo, 2.5mm, Angled Up 30°
3711124	Size o, 3.5mm, Angled Up 30°



### Thru-Flow Nasal Suction Forceps

Working length 154mm (6")

Catalog #	Description
3711137	2.5mm, Curved Up



### Weil-Blakesley Nasal Suction Forceps

Working length 100mm (3 7/8")

Catalog #	Description
3711072	Size 00, 2.5mm, Straight
3711073	Size 0, 3.5mm, Straight
3711074	Size 1, 4.0mm, Straight
3711075	Size 00, 2.5mm, Angled Up 30°
3711076	Size 0, 3.5mm, Angled Up 30°

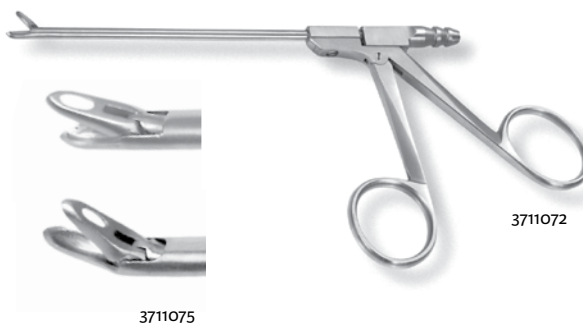

### Takahashi Nasal Suction Forceps

Working length 100mm (3 7/8")

Catalog #	Description
3711077	2.5 x 8.5mm, Straight
3711078	3.5 x 8.5mm, Straight



**NASAL GOUGES**

**Parkes Hump Gouge**

Overall length 177mm (7"), Double-Guarded



Catalog #	Description
3714106	6.0mm Wide

**NASAL HOOKS**

**Converse Skin Hook**

Overall length 183mm (7¼")



Catalog #	Description
3714364	2.5mm, Small
3714365	4.25mm, Large

3714364

**Cottle Double Hook**

Overall length 155mm (6")



Catalog #	Description
3714113	3.0mm Wide

**Cottle-Joseph Double Hook**

Overall length 137mm (5¾")



Catalog #	Description
3714110	12.0mm Wide

**Cottle Skin Hook**

Overall length 147mm (5¾")



Catalog #	Description
3714107	3.8mm, Shallow Curve, Small
3714108	3.8mm, Deep Curve, Small
3714109	5.0mm, Deep Curve, Large

3714108

### Double Fixation Hook

Catalog #	Description
3714043	1.5mm, 122mm (4¾")
3714044	2.5mm, 128mm (5")
3714045	3.0mm, 122mm (4¾")



3714044

### Frazier Skin Hook

Overall length 147mm (5¾")

Catalog #	Description
3724256	3.75mm, Small



### Johnson Skin Hook

Overall length 165mm (6½")

Catalog #	Description
3714651	4.5mm, Sharp



### Joseph Skin Hook

Overall length 160mm (6¼")

Catalog #	Description
3714020	2.0mm Wide
3714021	5.0mm Wide
3714022	7.0mm Wide
3714023	10.0mm Wide



3714020

### Joseph Skin Hook

Overall length 160mm (6¼")

Catalog #	Description
3714019	5.9mm, Single Hook



**Kleinert-Kutz Skin Hook**

Overall length 158mm (6¼")

Catalog #	Description
3714024	3.0mm, Small
3714025	5.0mm, Medium
3714026	7.0mm, Large



**Millard Double Hook**

Overall length 82mm (3¼")

Catalog #	Description
3714266	With Thimble



**Sisson Nerve Hook**

Overall length 152mm (6")

Catalog #	Description
3714111	6.0mm, Blunt Hook, Angled 90°



### Ballenger Swivel Knife

Overall length 198mm (7¾"), Bayonet

Catalog #	Description
3714164	3.0mm
3714165	4.0mm
3714166	5.0mm



### Ballenger Swivel Knife

Overall length 217mm (8½"), Straight

Catalog #	Description
3714167	3.0mm
3714168	4.0mm
3714169	5.0mm



### Cottle Nasal Knife

Overall length 136mm (5⅜")

Catalog #	Description
3714173	5.0 x 30.5mm Blade



### Dacryocystorhinostomy Sickle Knife

Overall length 148mm (5⅞")

Catalog #	Description
3718010	4.3mm, Sickle Knife, Curved
3718020	3.1mm, Diamond Knife, Angled 90°



3718010

3718020

### Freer Septum Knife

Catalog #	Description
3714433	Angled, 180mm (7")
3714432	"E" Model, 5.3mm x 9.0mm, 165mm (6½")
3714163	"D" Model, 5.0mm x 7.5mm, 165mm (6½")



3714432

**NASAL KNIVES**

**Joseph Button End Knife**

Catalog #	Description
3714172	10.0mm, Angled 50°, 172mm (6¾")
3714171	30.0mm, Straight, 152mm (6")



**Joseph Nasal Knife**

Overall length 158mm (6¼"),  
Double-Edged

Catalog #	Description
3714678	7.0mm, Blunt Tip, Curved



**Maltz Cartilage Knife**

Overall length 173mm (6¾")

Catalog #	Description
3714438	10.0mm, Angled 50°, Guarded



**Sickle Knife**

Overall length 190mm (7½")

Catalog #	Description
3714282	10.0mm, Sharp Tip, Curved Up
3714244	10.0mm, Blunt Tip, Curved Up
3714245	10.0mm, Sharp Tip, Curved Right
3714246	10.0mm, Sharp Tip, Curved Left



**NASAL SAWS**

**Joseph Nasal Saw**

Overall length 190mm (7½")

Catalog #	Description
3714673	38.0mm, Angled Left, Bayonet
3714674	38.0mm, Angled Right, Bayonet
3714162	38.0mm, Straight



### Copper Head Mallet

Overall length 179mm (7")

Catalog #	Description
3714350	20.0 x 33.0mm Head, 113 Grams (4oz.)



### Cottle Mallet

Overall length 185mm (7¼")

Catalog #	Description
3714353	25.0mm Nylon Head, 198 Grams (7oz.)



### Lucae Mallet

Overall length 192mm (7½")

Catalog #	Description
3714104	25.0 x 50.0mm Stainless Head, 255 Grams (9oz.)



### Gerzog Mallet

Overall length 190mm (7½")

Catalog #	Description
3714351	25.0 x 36.0mm, Lead Filled, 227 Grams (8oz.)



### Mallet, W/Nylon Heads

Overall length 190mm (7½")

Catalog #	Description
3714105	25.0mm Nylon Heads, 198 Grams (7oz.)

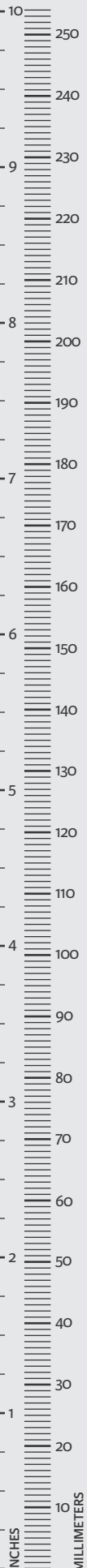



## NASAL MALLETS

### Mead Mallet

Overall length 190mm (7½")

Catalog #	Description
3714352	26.0 x 56.0mm Stainless Head, 325 Grams (11.5oz.)



## NASAL MORSELIZERS

### Rubin Septum Morselizer

Overall length 190mm (7½")

Catalog #	Description
3711032	6.0 x 11.0mm Jaws, Angled Handles



### Rubin Septum Morselizer, Guard

Catalog #	Description
3711034	Guard for 3711032



## NASAL NEEDLE HOLDERS

### Parell Needle Holder, Tungsten-Carbide

Catalog #	Description
3714034	1.5 x 13.0mm Tapered Jaws, 152mm (6")
3714035	1.5 x 15.0mm Tapered Jaws, 178mm (7")



3714034

## NASAL NEEDLES

### Sinus Septum Needle, Angled Shaft

Working length 85mm (3<sup>3</sup>/<sub>8</sub>" ), Straight Tip



Catalog #	Description
3714247	23GA, (0.6mm O.D.) x 15.0mm Needle

### Sinus Septum Needle, Bayonet Shaft

Working length 70mm (2<sup>3</sup>/<sub>4</sub>" ), Straight Tip



Catalog #	Description
3714249	23GA, (0.6mm O.D.) x 15.0mm Needle

## NASAL OSTEOTOMES

### Anderson-Neivert Osteotome

Overall length 204mm (8" ), Single-Guarded



Catalog #	Description
3714094	4.0mm, Curved Right
3714095	4.0mm, Curved Left

### Cinelli Osteotome

Overall length 159mm (6<sup>1</sup>/<sub>4</sub>" ), Double-Guarded



Catalog #	Description
3714100	10.0mm Wide
3714101	12.0mm Wide
3714102	14.0mm Wide

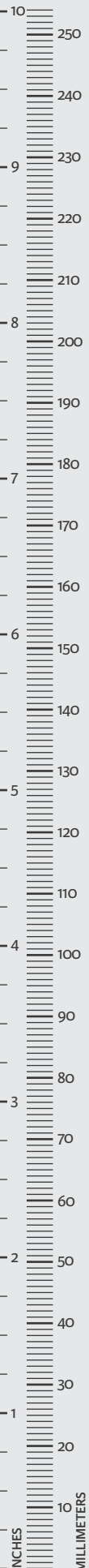

### Cottle Osteotome

Overall length 185mm (7¼"), Rounded Corners  
Depth Markings at 40, 50, 60 and 70mm

Catalog #	Description
3714071	4.0mm Wide
3714072	7.0mm Wide
3714073	9.0mm Wide
3714074	12.0mm Wide



3714071

### Neivert Osteotome

Overall length 203mm (8"), Single-Guarded

Catalog #	Description
3714338	4.0mm, Straight



### Hexagonal Handle Osteotomes

Overall length 159mm (6¼")

Catalog #	Description
3714059	2.0mm Wide
3714060	3.0mm Wide
3714062	4.0mm Wide
3714063	5.0mm Wide
3714064	6.0mm Wide
3714065	7.0mm Wide
3714066	8.0mm Wide
3714067	9.0mm Wide
3714068	10.0mm Wide
3714070	12.0mm Wide



3714059

### Parkes Lateral Osteotome

Overall length 167mm (6½"), Single-Guarded

Catalog #	Description
3714096	4.0mm Wide



### Rubin Osteotome

Overall length 170mm (6¾")  
Finger Grip, Rounded Corners



3714075

Catalog #	Description
3714075	10.0mm Wide
3714076	14.0mm Wide
3714077	16.0mm Wide

### Silver Osteotome

Overall length 180mm (7"), Single-Guarded



3714098

Catalog #	Description
3714097	5.0mm, Straight
3714098	5.0mm, Curved Right
3714099	5.0mm, Curved Left

### Swiss Osteotomes

Overall length 125mm (4⅞"), Straight

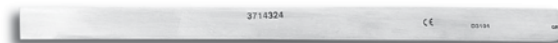

3714324

Catalog #	Description
3714321	2.0mm Wide
3714322	4.0mm Wide
3714323	6.0mm Wide
3714324	8.0mm Wide
3714325	10.0mm Wide
3714326	12.0mm Wide
3714327	15.0mm Wide

### Swiss Osteotomes

Overall length 130mm (5⅞"), Curved



3714330

Catalog #	Description
3714329	2.0mm Wide
3714330	4.0mm Wide
3714331	6.0mm Wide
3714332	8.0mm Wide
3714333	10.0mm Wide
3714334	12.0mm Wide
3714335	15.0mm Wide

**NASAL OSTEOTOMES**

**Tardy Osteotome**

Overall length 160mm (6¼")

Catalog #	Description
3714078	2.0mm Wide



**Osteotome, (Tardy Style)**

Overall length 160mm (6¼")

Catalog #	Description
3714090	5.0mm, Curved Right, Guarded
3714091	5.0mm, Curved Left, Guarded
3714092	5.0mm, Straight, Right Guarded
3714093	5.0mm, Straight, Left Guarded



**NASAL OSTIUM SEEKERS**

**Frontal Ostium Seeker**

Overall length 205mm (8"), Double-Ended

Catalog #	Description
3714231	1.5mm Ball Tips, One End Angled 90°



**Ostium Probe**

Overall length 208mm (8¼"), Double-Ended

Catalog #	Description
3714600	1.25mm Ball Tips, One End 90° Angled



**Maxillary Ostium Seeker**

Overall length 190mm (7½")

Catalog #	Description
3714232	2.3 and 2.6mm Ball Tips



## NASAL PICKS

### Mushroom Pick

Overall length 159mm (6¼"), Angled Shaft



Catalog #	Description
1352431	0.6mm, Piston Gauge

## NASAL PROBES

### Skilern Sinus Probe

Overall length 165mm (6½")



Catalog #	Description
3714233	Beaded Graduations at 50, 75 and 100mm

## NASAL PUNCHES AND BACKBITERS

### Hajek-Koffler Antrum Punch

Working length 140mm (5½"), 4.0mm Bite



Catalog #	Description
3712023	90°, Down-Cutting
3712024	90°, Up-Cutting
3712028	45°, Backward-Cutting
3712029	45°, Forward-Cutting



3712023



3712028



3712029

### Articulating Frontal Sinus Punch

Working length 140mm (5½"), 70° Upturned

Catalog #	Description
3712118	2.0mm, Angled 70° Up-Bite
3712119	3.0mm, Angled 70° Up-Bite
3712124	4.0mm, Angled 70° Up-Bite

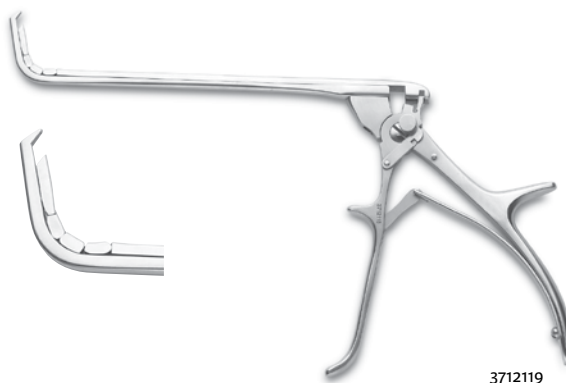

3712119

### Backbiter Forcep, Rotating

Working length 100mm (3⅞")

Catalog #	Description
3712013	Pediatric, 1.5mm x 5.2mm Bite
3712014	Adult, 2.5mm x 7.0mm Bite



3712013

### Circular Cutting Punch

Working length 160mm (6¼")

Catalog #	Description
3712039	3.5mm Bite, Angled 60° Up
3712042	4.5mm Bite, Angled 60° Up
3712038	3.5mm, Straight
3712040	4.5mm, Straight

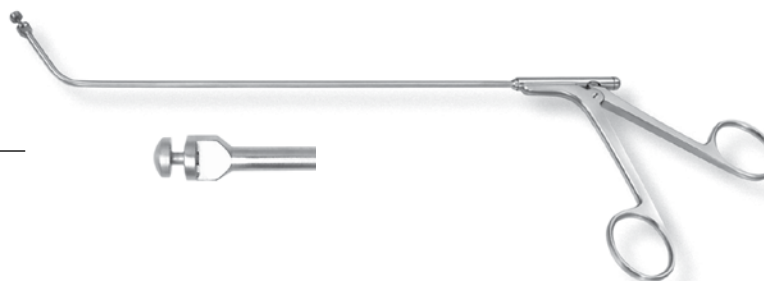

3712042



3712040

**Hajek-Koffler Sphenoid Punch, Rotating**  
Working length 170mm (6¾")

Catalog #	Description
3712022	3.0 x 6.5mm, Upbite 90°



**Hajek-Koffler Punch, Thru-Cut**  
Working length 165mm (6½")

Catalog #	Description
3712044	2.5 x 7.0mm, Upbite 90°



**McKenty Sphenoid Punch, Thru-Cut**  
Working length 85mm (3¾"), Rotating

Catalog #	Description
3712025	2.0 x 5.5mm, Upbite 90°



**Micro Backbiter Forceps**  
Working length 100mm (3⅞"), Rotating

Catalog #	Description
3712012	2.0 x 4.0mm, Curved Down
3712043	2.0 x 4.0mm, Curved Up



3712012



**Ostrum Antrum Backbiter Punch**

Working length 100mm (3 7/8")

Catalog #	Description
3712032	2.5 x 7.0mm, Up-Bite, Adult
3712033	2.5 x 7.0mm, Left-Bite, Adult
3712034	2.5 x 7.0mm, Right-Bite, Adult
3712035	1.5 x 5.2mm, Up-Bite, Pediatric
3712036	1.5 x 5.2mm, Left-Bite, Pediatric
3712037	1.5 x 5.2mm, Right-Bite, Pediatric



3712032



3712035

**Punch Rongeur**

Working length 180mm (7")

With Cleaning Port and Stylet Ejector

Catalog #	Description
3712026	2.0mm, 178mm (7")
3712027	3.0mm, 152mm (6")



3712026

**Antrum Punch, Sidebiting**

Working length 100mm (3 7/8")

Catalog #	Description
3712107	2.5 x 3.5mm, Left, Pediatric
3712108	2.5 x 3.5mm, Right, Pediatric
3712116	3.5 x 5.0mm, Down-Bite Right
3712117	3.5 x 5.0mm, Down-Bite Left
3712030	3.5 x 5.0mm, Right
3712031	3.5 x 5.0mm, Left

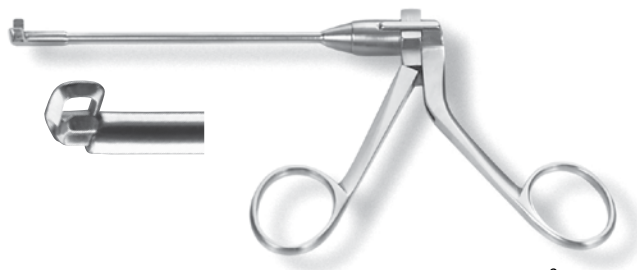

3712108

### Converse Rasp

Overall length 178mm (7"), Double-Ended

Catalog #	Description
3714667*	1 Fine, 1 Coarse Blade

\*Not for sale in US



### Fomon Rasp

Overall length 210mm (8¼"), Double-Ended  
One Convex and One Flat Blade

Catalog #	Description
3714148	7.5mm, Fine Teeth
3714149	7.5mm, Coarse Teeth



3714149

### Glabella Rasp, Tungsten-Carbide

Overall length 203mm (8")

Catalog #	Description
3714672	6.0 x 10.0mm, Downward Cutting



**Nasal Rasp, Tungsten-Carbide**

Overall length 212mm (8½"), Double-Ended

Catalog #	Description
3714150	Downward Cutting, Grits 1 and 2
3714151	Downward Cutting, Grits 3 and 4
3714152	Downward Cutting, Grits 5 and 6
3714153	Downward Cutting, Grits 7 and 8



**Wiener Antrum Rasp**

Overall length 190mm (7½")

Catalog #	Description
3714401	5.0mm, Large Trocar Tip
3714402	4.0mm, Small Trocar Tip



### Army-Navy Retractor

Overall length 215mm (8½")

Catalog #	Description
3714018	Double-Ended, Set of 2



### Aufricht Nasal Retractor

Catalog #	Description
3714192	8.5 x 45.0mm Blade, 156mm (6¼")
3714193	9.0 x 60.0mm Blade, 160mm (6¼")



### Blair Retractor

Overall length 135mm (5⅜")

Catalog #	Description
3714184	8.0mm, Four-Prong, Sharp



### Cheek Retractor

Overall length 206mm (8")

Catalog #	Description
3714178	31.0mm Wide Swivel Blade



### University of Minnesota Cheek Retractor

Catalog #	Description
3714450	Overall length 155mm (6")

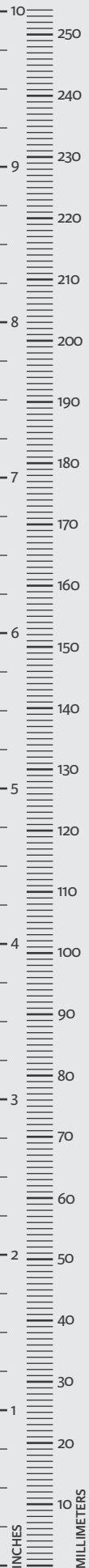

**Converse Nasal Retractor**

Overall length 110mm (4<sup>3</sup>/<sub>8</sub>" )

Catalog #	Description
3714179	14.0 x 45.0mm Blade



**Cottle Alar Retractor**

Overall length 136mm (5<sup>3</sup>/<sub>8</sub>" )

Catalog #	Description
3714187	11.8mm Blade



**Cottle Knife Guide and Retractor**

Overall length 200mm (7<sup>3</sup>/<sub>4</sub>" ), Double-Ended

Catalog #	Description
3714180	12.0mm Ball Tip Prongs, 5.0mm Retractor Blade



**Cottle Neivert Retractor**

Overall length 217mm (8<sup>1</sup>/<sub>2</sub>" ), Double-Ended

Catalog #	Description
3714684	10.5mm Blunt Prongs, 5.0mm Retractor Blade



**Cottle Retractor**

Overall length 133mm (5<sup>1</sup>/<sub>4</sub>" )

Catalog #	Description
3714182	Right Prong Sharp
3714183	Left Prong Sharp



3714182

**Cushing Vein Retractor**

Overall length 230mm (9" )

Catalog #	Description
3714017	12.0mm Wide Blade



**Fomon Retractor**

Overall length 158mm (6¼")

Catalog #	Description
3714181	13.0mm Ball Tip Prongs



**Freer Hook/Retractor**

Overall length 150mm (5⅞")

Catalog #	Description
3714029	2-Prong Sharp



**Knapp Retractor**

Overall length 146mm (5¾")

Catalog #	Description
3714027	7.6mm, 4-Prong Sharp
3714028	7.6mm, 4-Prong Blunt



3714027

**Love Nerve Root Retractor**

Overall length 205mm (8")

Catalog #	Description
3714016	6.0mm Blade, Straight



**NASAL RETRACTORS**

**Ragnell Retractor**

Overall length 145mm (5¾"), Double-Ended



Catalog #	Description
3714033	2.5 and 5.0mm Wide Blades

**Senn Retractor**

Overall length 160mm (6¼"), Double-Ended



Catalog #	Description
3714031	Sharp
3714032	Blunt

3714032

**Goldman Knife Guide and Retractor**

Overall length 172mm (6¾"), Double-Ended



Catalog #	Description
3714451	11.5mm Ball Tip Prongs, Right
3714452	11.5mm Ball Tip Prongs, Left

3714451

**Neivert Knife Guide and Retractor**

Overall length 200mm (7¾"), Double-Ended



Catalog #	Description
3714681	10.5mm Knife Guide, 13.0mm Retractor

**NASAL RONGEURS**

**Beyer Rongeur**

Overall length 180mm (7"), Single-Action



Catalog #	Description
3712008	16.0mm, Curved

### Mini Friedman Rongeur

Overall length 140mm (5½"), Single-Action

Catalog #	Description
3712200	1.25 x 6.0mm, Straight
3712201	1.5 x 6.0mm, Curved

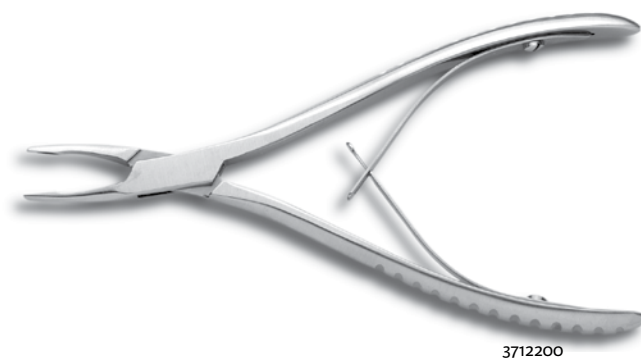

3712200

### Kerrison Mastoid Rongeur

Working length 100mm (3⅞"), Angled Up 90°

Catalog #	Description
3724074	No. 0, 3.5mm Bite
3712015	No. 1, 4.0mm Bite
3712016	No. 2, 4.5mm Bite
3712017	No. 3, 5.0mm Bite



3712016

### Kerrison-Costen Rongeur

Working length 100mm (3⅞"), Angled Down 90°

Catalog #	Description
3712021	4.0 x 8.0mm Bite, Shaft Curved Down

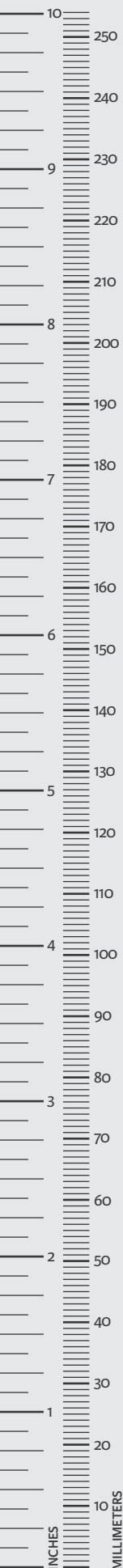



**Ruskin Mini Rongeur**

Overall length 150mm (5<sup>7</sup>/<sub>8</sub>" ), Double-Action

Catalog #	Description
3712212	2.0mm, Straight
3712009	3.0mm, Straight
3712010*	3.0mm, Curved

\*Not for sale in US



3712010

**Lempert Rongeur, Heavy Pattern**

Overall length 190mm (7<sup>1</sup>/<sub>2</sub>" ), Single-Action

Catalog #	Description
3712002	3.5 x 9.0mm, Straight
3712003	3.5 x 9.0mm, Curved

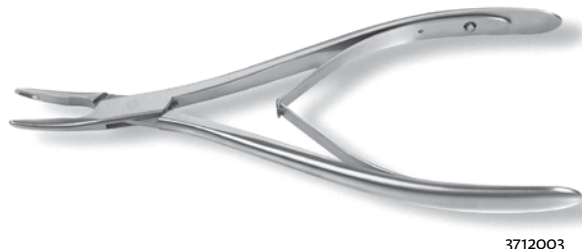

3712003

**Rowland Bone Rongeur**

Overall length 190mm (7<sup>1</sup>/<sub>2</sub>" ), Double-Action

Catalog #	Description
3712219	Straight, Narrow Blades



**Ruskin Rongeur**

Overall length 190mm (7<sup>1</sup>/<sub>2</sub>" ), Double-Action

Catalog #	Description
3712210	5.0mm, Straight
3712211	5.0mm, Curved



3712211

### Becker Septum Scissors

Working length 99mm (3<sup>7</sup>/<sub>8</sub>" ), Double-Action

Catalog #	Description
3713020	45.0mm, Serrated Blades



### Caplan Nasal Bone Scissors, Double-Action

Catalog #	Description
3713063	45.0mm, Serrated Blades



### Converse Dural Scissors

Overall length 160mm (6<sup>1</sup>/<sub>4</sub>" )

Catalog #	Description
3713061	26.0mm, Serrated Blades



### Cottle Dorsal Scissors

Working length 87mm (3<sup>3</sup>/<sub>8</sub>" )

Catalog #	Description
3713060	Angled Shanks, Heavy Pattern
3713002	Angled Shanks, One Blade Serrated



3713002



**Dorsal Scissors**

Overall length 125mm (4<sup>7</sup>/<sub>8</sub>"

Catalog #	Description
3713032	39.0mm, Straight, Blunt Tips



**Fomon Dissecting Scissors**

Overall length 143mm (5<sup>5</sup>/<sub>8</sub>"

Catalog #	Description
3713059	Curved Sabre Back Blade, Blunt Tips, Semi-Sharp Outer Edges



**Fomon Dorsal Scissor, Tungsten-Carbide**

Overall length 145mm (5<sup>3</sup>/<sub>4</sub>"

Catalog #	Description
3713000	Straight Round Blades, Angled Shanks



**Fomon Dorsal Scissors**

Overall length 140mm (5<sup>1</sup>/<sub>2</sub>"

Catalog #	Description
3713023	Straight Beveled Blades, Angled Shanks



**Fomon Lower Lateral Scissors**

Overall length 128mm (5")

Catalog #	Description
3713024	Full Curved Blades



**Fomon Saber Back Scissors**

Overall length 127mm (5")

Catalog #	Description
3713056	Curved Stainless Steel Blades, Serrated
3713001	Curved Tungsten Carbide Blades, Serrated



3713001

**Goldman Septum Scissors**

Overall length 140mm (5½")

Catalog #	Description
3713022	Serrated Blades, Angled Shanks



**Gorney Turbinate Scissors**

Catalog #	Description
3713025	Serrated Blades, Angled Shanks

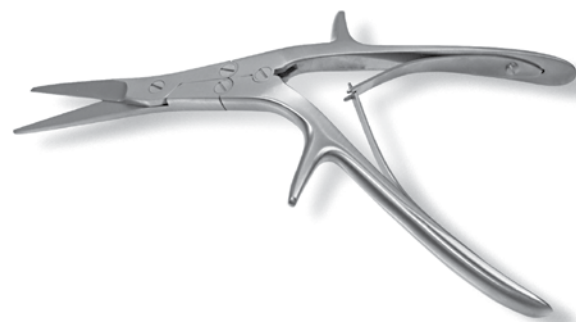

### Iris Scissors

One Sharp and One Serrated Blade

Catalog #	Description
3713003	30.0mm, Straight, 105mm (4 1/8")
3713004	34.0mm, Straight, 115mm (4 1/2")
3713005	30.0mm, Curved, 105mm (4 1/8")
3713006	34.0mm, Curved, 115mm (4 1/2")



3713003

### Knapp Strabismus Scissors

Overall length 118mm (4 5/8"), Blunt Tips

Catalog #	Description
3713015	26.0mm, Straight
3713016	26.0mm, Curved



3713015

### Knight Nasal Scissors

Catalog #	Description
3713055	Light Pattern, Working length 84mm (3 1/4")
3713054	Standard Pattern, Working length 102mm (4")



3713055

### Lakeside Nasal Scissors

Working length 107mm (4 1/4")

Catalog #	Description
3713018	Heavy Blades, Angled Shanks



**Nasal Sinus Scissors, Adult**

Working length 115mm (4½")

Catalog #	Description
3713029	13.5mm, Straight
3713030	13.5mm, Angled Left
3713031	13.5mm, Angled Right



**Nasal Sinus Scissors, Pediatric**

Working length 105mm (4⅛")

Catalog #	Description
3713026	8.0mm, Straight
3713027	8.0mm, Angled Left
3713028	8.0mm, Angled Right



**Ragnell Nasal Scissors**

Overall length 136mm (5⅜")

Catalog #	Description
3713058	Curved, Flat Dissecting Tips



**Stevens Tenotomy Scissors**

Overall length 110mm (4⅜")

Catalog #	Description
3713013	28.0mm, Straight
3713014	28.0mm, Curved



## NASAL SCISSORS

---

### Stevens Tenotomy Scissors

Catalog #	Description
3713009	28.0mm, Straight, 110mm (4 <sup>3</sup> / <sub>8</sub> " )
3713010	28.0mm, Curved, 110mm (4 <sup>3</sup> / <sub>8</sub> " )
3713012	34.5mm, Curved, 135mm (5 <sup>3</sup> / <sub>8</sub> " )



3713012

## NASAL SNARES

---

### Krause Nasal Snare

Complete with cannula and stylet

Catalog #	Description
3714194	Snare, 261mm (10 <sup>1</sup> / <sub>4</sub> " )
3714685	Stylet



3714194

### Snare Wire

Overall length 104mm (4<sup>1</sup>/<sub>4</sub>" )

Catalog #	Description
3714195	Size 0, 0.30mm
3714197	Size 2, 0.40mm
3714198	Size 3, 0.50mm



3714198

### Beckman Nasal Specula

Curved to side

Catalog #	Description
3714690	Size 0, 16.00mm, Infant, 133mm (5¼")
3714204	Size 1, 25.00mm, Small, 153mm (6")
3714691	Size 2, 28.00mm, Medium, 153mm (6")
3714692	Size 3, 30.00mm, Large, 153mm (6")



### Cottle Septum Speculum

Overall length 135mm (5⅜")

Catalog #	Description
3714472	4.0 x 50.0mm Thin Tapered Blades



### Cottle Specula

Overall length 132mm (5¼"), Narrow, Tapered Blades

Catalog #	Description
3714209	Size 1, 30.0mm, Tapered 9.0 to 4.0mm
3714210	Size 2, 35.0mm, Tapered 10.0 to 8.0mm
3714211	Size 3, 55.0mm, Tapered 10.0 to 6.0mm
3714212	Size 4, 55.0mm, Tapered 10.0 to 8.0mm
3714213	Size 5, 70.0mm, Tapered 10.0 to 8.0mm
3714214	Size 6, 80.0mm, Tapered 10.0 to 8.0mm
3714215	Size 7, 90.0mm, Tapered 10.0 to 8.0mm



### Halle Nasal Speculum

Overall length 160mm (6¼")

Catalog #	Description
3714687	32.0mm Blades





**Hartman Nasal Speculum**

Overall length 150mm (5<sup>7</sup>/<sub>8</sub>" )

Catalog #	Description
3714688	30.0mm Blades, Adult



**Killian Septum Specula**

Overall length 135mm (5<sup>3</sup>/<sub>8</sub>" )

Catalog #	Description
3714205	51.0mm Blades
3714206	64.0mm Blades
3714207	76.0mm Blades
3714208	90.0mm Blades



3714208

**Septum Specula, Ebony**

Overall length 140mm (5<sup>1</sup>/<sub>2</sub>" )

Catalog #	Description
3714480	35.0mm Blades, Narrow
3714481	50.0mm Blades, Narrow
3714482	75.0mm Blades, Narrow
3714483	90.0mm Blades, Narrow



3714480

### Sonnenschein Nasal Speculum

Overall length 156mm (6¼")

Catalog #	Description
3714471	6.0 x 27.0mm Blades



### Tieck Infant Nasal Speculum

Overall length 140mm (5½")

Catalog #	Description
3714203	18.0mm Blades



### Vienna Nasal Specula, Original

Overall length 134mm (5¼")

Catalog #	Description
3714199	No. 1, 23.0mm Blades
3714200	No. 2, 28.0mm Blades
3714201	No. 3, 30.0mm Blades
3714202	No. 4, 33.0mm Blades



3714199

### Vienna Nasal Specula, Conventional

Overall length 140mm (5½")

Catalog #	Description
3714475	27.5mm Blades
3714476	30.0mm Blades
3714477	32.5mm Blades



3714477



## NASAL SPECULA

### Vienna Nasal Specula, Modified

Overall length 140mm (5½")

Catalog #	Description
3714478	27.0mm Blades
3714479	30.0mm Blades



3714479

## SUCTIONS

### Ferguson-Frazier Suction Tube, Angled

Working length 150mm (5⅞")

Catalog #	Description
3714259	6 French
3714260	7 French
3714261	8 French
3714262	9 French
3714263	10 French
3714264	12 French
3714265	14 French



3714259

### Ferguson-Frazier Suction Tube, Strong Angle

Working length 102mm (4")

Catalog #	Description
3714250	5 French
3714251	6 French
3714252	7 French
3714253	8 French
3714254	9 French
3714255	10 French
3714256	11 French
3714257	12 French
3714258	14 French
3714000S	Replacement Stylet, 6 French



3714256



### Frazier Suction Tube, Medium Angle

Working length 100mm (3<sup>7</sup>/<sub>8</sub>"")  
 Graduated in 10mm Increments

Catalog #	Description
3714000	6 French
3714001	7 French
3714002	8 French
3714003	9 French
3714004	10 French
3714005	11 French
3714006	12 French
3714007	14 French
3714000S	Replacement Stylet, 6 French



3714002

### Kahn-Frazier Suction Tube

Working length 140mm (5<sup>1</sup>/<sub>2</sub>""), Malleable

Catalog #	Description
3714049	10 French, No. 1
3714050	9 French, No. 2



3714049

### Laryngeal Suction Tube

Working length 270mm (10<sup>3</sup>/<sub>4</sub>"")

Catalog #	Description
3734109	2.0mm O.D.
3734110	2.5mm O.D.
3734111	3.0mm O.D.



3734111

### Von Eicken Suction Cannulas

Working length 88mm (3<sup>1</sup>/<sub>2</sub>"")

Catalog #	Description
3714494	2.5mm O.D., Long Curve
3714495	2.5mm O.D., Short Curve
3714237	3.0mm O.D., Long Curve
3714238	3.0mm O.D., Short Curve
3714239	4.0mm O.D., Short Curve
3714240	4.0mm O.D., Long Curve



3714237

3714238

## NASAL TROCARS AND CANNULA

---

### Lichtwicz Antrum Trocar Needle

Working length 110mm (4<sup>3</sup>/<sub>8</sub>" ), with Cross bar

Catalog #	Description
3714218	14 Gauge, Straight
3714219	16 Gauge, Straight
3714220	18 Gauge, Straight



### Ruskin Antrum Trocar Needle

Overall length 112mm (4<sup>3</sup>/<sub>8</sub>" ), with Cross Bar

Catalog #	Description
3714696	14 Gauge, Curved, W/50mm Marker



### Sinus Trocar and Cannula

Overall length 180mm (7")

Working length 90mm (3<sup>1</sup>/<sub>2</sub>" )

Catalog #	Description
3714241	4.0mm
3714242	5.0mm
3714243	2.7mm

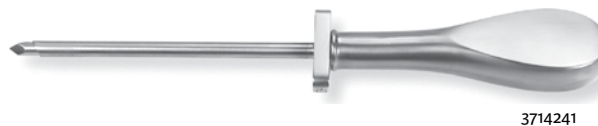

### Van Alyea Frontal Sinus Cannula

Catalog #	Description
3714490	Strong Curve, 168mm (6 <sup>1</sup> / <sub>2</sub> " )
3714491	Light Curve, 174mm (6 <sup>3</sup> / <sub>4</sub> " )

## Sinus Instrument Trays

**Catalog #**    **Description**

**3717000**    Holds 43 Instruments, Upper Insert Removable  
53.0cm L x 25.5cm W x 14.0cm D  
(20¾" L x 10" W x 5½" D)



3717000

**3717001**    Three Level Aluminum Trays with Plastic Lid  
Three Level  
53cm L x 25.5cm W x 15cm D  
(20¾" L x 9¾" W x 5⅞" D)



3717001

**3717002**    One Level  
52cm L x 25cm W x 2.8cm D  
(20½" L x 9¾" W x 1⅛" D)



3717002

**3717006**    Holds 43 Instruments, Upper Insert Removable,  
Lower Silicone Finger Mat for Versatility  
53.0cm L x 25.5cm W x 14.0cm D  
(20¾" L x 10" W x 5½" D)



3717006

**3717012**    Medium Tray  
38cm L x 25.5cm W x 7.4cm D  
(15" L x 10" W x 2⅞" D)

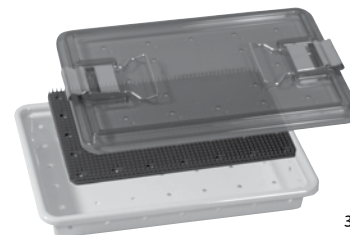

3717012

**MCOHoSC**    Includes 6 Silicone Straps, 12 Snap-In Posts,  
and Post Removal Tool  
54.6cm L x 25.9cm W x 12cm D  
(21½" L x 10¼" W x 4¾" D)

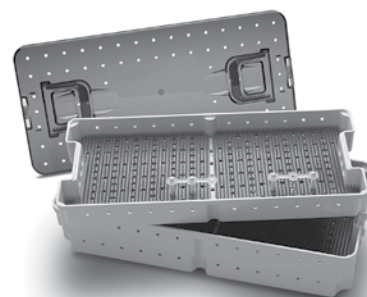

MCOHoSC





INTEGRA<sup>®</sup>  
LIMIT UNCERTAINTY



Integra<sup>®</sup>  
ENT Instrumentation  
General Throat Instruments

## ADENOTOMES

### Laforce Adenotomes

Overall length 230mm (9")



Catalog #	Description
3734018	Size 2, Medium, 16.0mm

## ADENOID CURETTES

### Adenoid Curettes (Disposable)

Catalog #	Description
1423004	Size 4, 17.0mm, 5/Pkg
1423002	Size 2, 13.0mm, 5/Pkg
1423000	Size 0, 7.0mm, 5/Pkg (Rosenmüller's Fossae Curette)

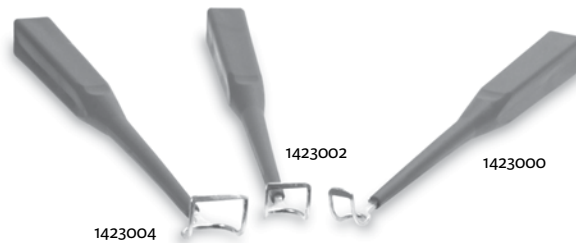

### Barnhill Adenoid Curettes

Overall length 215mm (8½")



Catalog #	Description
3734003	Size 0, 10.5mm Cutting Edge
3734004	Size 1, 13mm Cutting Edge
3734005	Size 2, 15mm Cutting Edge
3734006	Size 3, 17mm Cutting Edge
3734007	Size 4, 19mm Cutting Edge

### Middleton Adenoid Curette

Overall length 225mm (8¾")



Catalog #	Description
3734013	7.5mm Cutting Edge



**Stubbs Adenoid Curettes**

Overall length 220mm (8¾")

Catalog #	Description
3734131	Size 0, 11.0mm Blade
3734132	Size 1, 14.0mm Blade
3734133	Size 2, 16.0mm Blade
3734134	Size 3, 18.0mm Blade



3734134

**Reverse Adenoid Curettes**

Overall length 215mm (8½")

Catalog #	Description
3734008	Size 0, 10.0mm Blade
3734009	Size 1, 12.0mm Blade
3734010	Size 2, 14.0mm Blade
3734011	Size 3, 16.0mm Blade
3734012	Size 4, 18.0mm Blade



3734010

**FORCEPS**

**Allis-Coakley Tonsil Forceps**

Overall length 190mm (7½"), One Open Ring

Catalog #	Description
3731004	Curved
3731006	Straight



3731006

**Ferris-Smith Sponge/Fragment Forceps**

Working length 115mm (4⅛")

Catalog #	Description
3731055	5.5 x 8.0mm, Serrated



### Schmidt Tonsil Forceps

Overall length 192mm (7½"), Closed Ring

Catalog #	Description
3731058	Slight Curved



### Schmidt-Boettcher Tonsil Forceps

One Open Ring

Catalog #	Description
3731010	Straight, 192mm (7½")
3731056	Half Curved, 190mm (7½")
3731057	Full Curved, 185mm (7¼")



3731010

### St. Claire Thompson Adenoid Forceps

Overall length 195mm (7¼")

Catalog #	Description
3731054	5.8 x 13.0mm, 135° Jaw



### White Tonsil Forceps

Overall length 241mm (9½")

Catalog #	Description
3731007	6.0mm, Curved

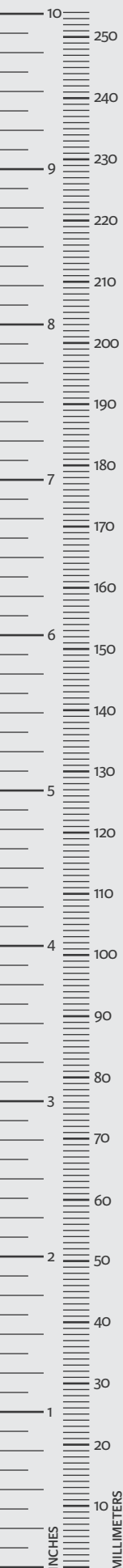

**Fisher Tonsil Knife**

Overall length 212mm (8¼")



Catalog #	Description
3734038	7.0 x 15.0mm, Serrated Blade

**Hurd Dissector/Pillar Retractor**

Overall length 223mm (8¾")



3734042

Catalog #	Description
3734042	Small, 7.0mm Dissector, 11.0mm Retractor
3734043	Large, 8.0mm Dissector, 13.0mm Retractor

**Morrison-Hurd Dissector and Pillar Retractor**

Overall length 226mm (9")



Catalog #	Description
3734045	7.0mm Serrated Dissector, 10.0mm Retractor

**MIRRORS**

**Laryngeal Mirrors**

Overall length 170mm (7½")



3734057

Catalog #	Description
3734048	Size 000, 8.0mm Diameter
3734049	Size 00, 10.0mm Diameter
3734050	Size 0, 12.0mm Diameter
3734051	Size 1, 14.0mm Diameter
3734052	Size 2, 16.0mm Diameter
3734053	Size 3, 18.0mm Diameter
3734147	Size 4, 20.0mm Diameter
3734054	Size 5, 22.0mm Diameter
3734055	Size 6, 24.0mm Diameter
3734056	Size 7, 26.0mm Diameter
3734057	Size 8, 28.0mm Diameter
3734058	Size 9, 30.0mm Diameter

### Oral Stabilizer

Longer lateral loop helps improve handpiece maneuverability and blade access when using powered instrumentation for T&A  
For use with Davis mouth gag blades and Davis ring blades

Catalog #	Description
3734000	Left
3734001	Right



3734000

### Davis Mouth Gag Set

Complete with 8 Blades

Catalog #	Description
3734073	Davis Mouth Gag Set
	Set Consists of the Following:
3734069	Frame, Double Bite Right Side
3734070	Frame, Double Bite Left Side



3734069

Blades consist of the following;

Catalog #	Description
3734075	Blade Size No. 1, 21.0 x 36.0mm
3734076	Blade Size No. 1.5, 23.0 x 52.0mm
3734077	Blade Size No. 2, 24.0 x 70.0mm
3734078	Blade Size No. 2.5, 24.0 x 73.0mm
3734079	Blade Size No. 3, 25.0 x 84.0mm
3734080	Blade Size No. 3.5, 25.0 x 86.0mm
3734081	Blade Size No. 4, 25.5 x 96.0mm
3734082	Blade Size No. 5, 25.5 x 110.0mm
3734071	Double Bite Right Side-Pediatric
3734072	Double Bite Left Side-Pediatric



3734077

**Davis Ring Blades**

Overall length 191mm (7½")

Catalog #	Description
3734083	Size 2, Left, 25.0mm x 58.0mm
3734084	Size 2, Right, 25.0mm x 58.0mm
3734085	Size 3, Left, 28.0mm x 72.0mm
3734086	Size 3, Right, 28.0mm x 72.0mm
3734087	Size 4, Left, 34.0mm x 87.0mm
3734088	Size 4, Right, 34.0mm x 87.0mm
3734089	Size 5, Left, 38.0mm x 96.0mm
3734090	Size 5, Right, 38.0mm x 96.0mm



**Denhardt Mouth Gag**

Overall length 120mm (4¾")

Catalog #	Description
3734151	30.0mm Spread



**Dingman Mouth Gag Set**

Complete Set With Three Tongue Blades

Catalog #	Description
3734059	Dingman Mouth Gag Set Consist of the following items:
3734060	Small, 24.0 x 65.0mm Blades
3734061	Medium, 28.0 x 70.0mm Blades
3734062	Large, 30.0 x 82.0mm Blades



**Jennings Mouth Gags**

Catalog #	Description
3734148	Small Size, 125mm (4⅝")
3734149	Medium Size, 145mm (5¾")
3734150	Large Size, 155m (6")

### Mclvor Mouth Gag Set

Complete Set with Frame and 3 Blades

Catalog #	Description
3734065	Mclvor Mouth Gag Set Consist of the following items:
3734152	Frame Only, 145mm (5¾")
3734066	Size 1, 23.5 x 74.0mm Blades
3734067	Size 2, 25.5 x 90.0mm Blades
3734068	Size 3, 26.5 x 102.0mm Blades



3734152

### PUNCHES

#### King Adenoid Punch

Working length 115mm (4½") Triangular End

Catalog #	Description
3731003	7.0mm, Triangular Bite



#### Meltzer Adenoid Punch

Working length 140mm (5½") Triangular End

Catalog #	Description
3731000	6.0mm, Triangular Bite
3731001	7.0mm, Triangular Bite
3731002	8.0mm, Triangular Bite

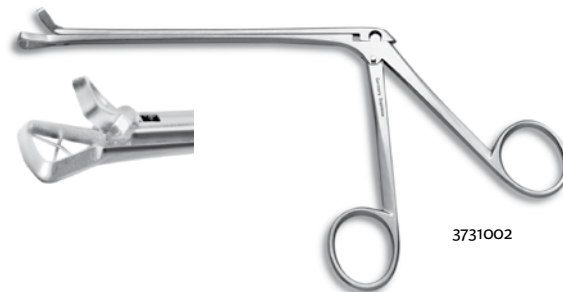

3731002

#### Ronis Adenoid Punch

Working length 130mm (5⅛") Triangular End

Catalog #	Description
3731052	7.0mm, Triangular Bite
3731053	8.0mm, Triangular Bite



3731052

**RETRACTORS**

---

**Goodyear Uvula Retractor**

Working length 87mm (3½")

Catalog #	Description
3734091	15.0mm Blade



**Love Uvula Retractor**

Catalog #	Description
3734153*	18mm Wide Blade

\*Not for sale in US



**News Tracheal Retractor**

Overall length 150mm (5⅝")

Catalog #	Description
3734047	Sharp Curved Point



**Wieder Tongue Depressor ("Sweetheart Retractor")**

Working length 92mm (3¾")

Catalog #	Description
3734092	Small, 29.0 x 45.0mm, Serrated
3734093	Large, 38.0 x 44.0mm, Serrated



3734092

### Dean Tonsil Scissors

Overall length 172mm (6¼")

Catalog #	Description
3733001	Angled, One Blade Serrated



### Metzenbaum Scissors

Overall length 177mm (7")

Catalog #	Description
3733021	Curved



### SNARES

#### Eve Tonsil Snare

Overall length 286mm (11¼")

Catalog #	Description
3734105	Without Ratchet



#### Sage Tonsil Snare, Straight Tip

Catalog #	Description
3734096	Overall length 279mm (11"), Fully Retracted, Working length 210mm (8¼"), Fully Extended

3734097	Size 7, Cut Snare Wire, .045mm
---------	--------------------------------



3734096



### Snare Wire, Pre-Cut

Catalog #	Description
3734103	0.4mm, 115.0mm Long, 12/Pkg
3734104	0.5mm, 115.0mm Long, 12/Pkg
3734160	0.3mm, 90.0mm Long, 12/Pkg



### Tyding Tonsil Snare

Catalog #	Description
3734100	Straight, 250mm (9¾"), Fully Retracted

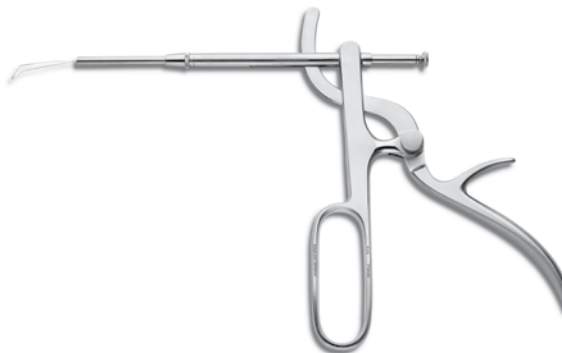

### SUCTION TUBES

#### Andrews Suction Tube

Overall length 240mm (9¼")

Catalog #	Description
3734157	5 French



#### Andrews-Pynchon Suction Tube

Overall length 229mm (9")

Catalog #	Description
3734158	5 French



#### Yankauer Suction Tube

Catalog #	Description
3734156	210mm (8¼"), Small, Narrow Handle
3734155	310mm (12¼")



3734155

## TONSIL NEEDLE

### Tonsil Needle

Overall length 108mm (4 1/4")

Catalog #	Description
3734108	23GA, 13.0mm Angled
3734107	23GA, 19.0mm Straight



3734108

## TRACHEAL DILATORS

### Trousseau Tracheal Dilator

Overall length 145mm (5 3/4")

Catalog #	Description
3734167	5.0mm Jaw, Curved

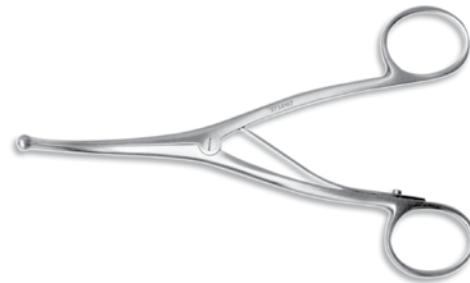

### Laborde Tracheal Dilator

Overall length 152mm (6")

Catalog #	Description
3734168	5.0mm Jaw, Three Blades, Curved



## MISCELLANEOUS

### Mustard Table

Attaches Directly to OR Table Sideframe  
Edge Slots Permit Easy Adjustments

Catalog #	Description
3734500	Mustard Table
3734510	Mustard Table Adapter



3734500

INTEGRA<sup>®</sup>  
LIMIT UNCERTAINTY



Integra<sup>®</sup>  
ENT Instrumentation  
Laryngeal Instruments

### Netterville Thyroplasty Instrument Set

Includes five instruments designed to facilitate measurement, elevation and dissection of tissue in laryngeal surgery

Aids in preparation of surgical site and medialization material in augmentation of laryngeal tissues

Developed in Conjunction with James I. Nettekville, M.D.



Catalog #	Description
7060000**	Netterville Thyroplasty Instrument Set

Set includes:

- 7060111 Silicone Strip Holder
- 7060112 Long Elevator
- 7060113 Double-Ended Elevator
- 7060114 Window Template
- 7060115 Measuring Probe
- 7060116 Instrument Tray

\*\*Not for sale outside US

### Silicone Strip Holder

Holds the implant material during trimming

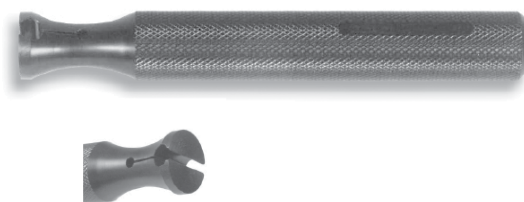

Catalog #	Description
7060111	Silicone Strip Holder

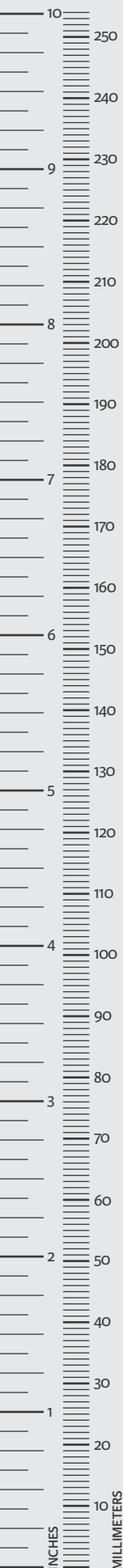

### Long Elevator

Elevates the inner perichondrium from the thyroid cartilage

Catalog #	Description
7060112	Long Elevator



### Double-Ended Elevator

Elevates the inner perichondrium from the thyroid cartilage

Dissects the posterior border of the thyroid to the pyriform sinus to assist in arytenoid adduction procedures

Catalog #	Description
7060113	Double-Ended Elevator



### Window Template

Non-slip design and easy-to-read gauge helps placement and sizing of window

Catalog #	Description
7060114	9.0 x 13.0mm



### Measuring Probe

Double-ended, male and female, marked in millimeters to assist in determining the appropriate amount of medialization

Catalog #	Description
7060115	Measuring Probe



### Instrument Tray

Catalog #	Description
7060116	Instrument Tray



### Laryngeal Handle

For use with 37334115 through 3734119



Catalog #	Description
3734114	115mm (4½")

### Laryngeal Knife

Overall length 250mm (9¾")

Catalog #	Description
3734115	2.9mm, Round, Curved
3734117	8.0mm, Pointed, Curved



### Laryngeal Suction Tube

Overall length 270mm (10¾")

Catalog #	Description
3734109	2.0mm O.D.
3734110	2.5mm O.D.
3734111	3.0mm O.D.

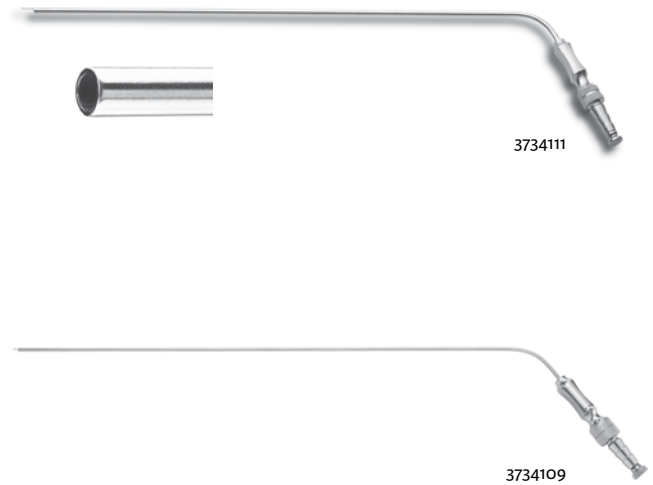

### Jako Microlaryngeal Alligator Forceps

Working length 235mm (9¼"), W/Cleaning Port

Catalog #	Description
3731042	9.0mm, Straight, Serrated Jaws
3731043	9.0mm, Curved Up, Serrated Jaws
3731044	9.0mm, Curved Right, Serrated Jaws
3731045	9.0mm, Curved Left, Serrated Jaws

### Jako Microlaryngeal Cup Forceps

Working length 235mm (9¼"), W/Cleaning Port

Catalog #	Description
3731038	2.0mm Cups, Straight
3731039	2.0mm Cups, Curved Left
3731040	2.0mm Cups, Curved Right
3731041	2.0mm Cups, Curved Up



3731038

### Jako Microlaryngeal Scissors

Working length 235mm (9¼"), W/Cleaning Port

Catalog #	Description
3733014	4.0mm Blades, Straight, Vertical
3733015	4.0mm Blades, Straight, Horizontal
3733016	4.0mm Blades, Curved Left
3733017	4.0mm Blades, Curved Right
3733018	4.0mm Blades, Curved Up



3733014

### Jako Microlaryngeal Knives

Catalog #	Description
3734123	10.5mm, Sickle Blade, 294mm (11½")
3734124	10.0mm, Straight Blade, 314mm (12¼")



3734123

3734123

### Jako Laryngeal Probes

Catalog #	Description
3734125	2.0mm, Probe Tip, Straight, 300mm (11¾")
3734126	2.0mm, Probe Tip, Angled 90°, 295mm (11½")



3734125

3734125



### Kleinsasser Microlaryngeal Alligator Forceps

Working length 275mm (10¾"), W/Cleaning Port

Catalog #	Description
3731035	9.0mm, Straight, Serrated Jaws
3731036	9.0mm, Curved Right, Serrated Jaws
3731037	9.0mm, Curved Left, Serrated Jaws



3731035

### Kleinsasser Microlaryngeal Cup Forceps

Working length 275mm (10¾"), W/Cleaning Port

Catalog #	Description
3731030	1.0mm Cups, Straight
3731031	2.0mm Cups, Straight
3731032	1.0mm Cups, Curved Right
3731033	1.0mm Cups, Curved Left
3731034	1.0mm Cups, Curved Up



3731030

### Kleinsasser Laryngeal Mini Cup Forceps

Working length 250mm (9¾"), W/Cleaning Port

Catalog #	Description
3731011	1.0mm Cups, Straight
3731013	1.0mm Cups, Curved Right



3731011

### Kleinsasser Laryngeal Mini Forceps

Working Length 257mm (10"), W/Cleaning Port

Catalog #	Description
3731017	9.0mm, Straight, Serrated Jaws
3731020	9.0mm, Curved Up, Serrated Jaws



3731017





**Kleinsasser Microlaryngeal Scissors**

Working length 255mm (10"), W/Cleaning Port

Catalog #	Description
3733002	5.0mm Blades, Straight
3733003	5.0mm Blades, Angled Up 45°
3733004	5.0mm Blades, Curved Right
3733005	5.0mm Blades, Curved Left



3733002

**Kleinsasser Microlaryngeal Scissors**

Working length 275mm (10¾"), W/Cleaning Port

Catalog #	Description
3733006	4.0mm Blades, Straight, Horizontal
3733007	4.0mm Blades, Straight, Vertical
3733008	4.0mm Blades, Curved Left
3733009	4.0mm Blades, Curved Right
3733010	4.0mm Blades, Angled Up 45°



3733006

**Kleinsasser Original Cup Forceps**

Working length 257mm (10"), W/Cleaning Port

Catalog #	Description
3731022	2.0mm Cups, Curved Up
3731023	2.0mm Cups, Curved Right
3731024	2.0mm Cups, Curved Left
3731025	2.0mm Cups, Curved Up, Right
3731026	2.0mm Cups, Curved Up, Left



3731022

### Blitzer Laryngeal Knives (Disposable)

Overall length 254mm (10"), Graduated, Angled Tips

Designed in conjunction with Andrew Blitzer, MD

Catalog #	Description
1422100	Spear Tip, 5/Pkg
1422200	Circular Tip, 5/Pkg
1422300	Sickle Tip, 5/Pkg

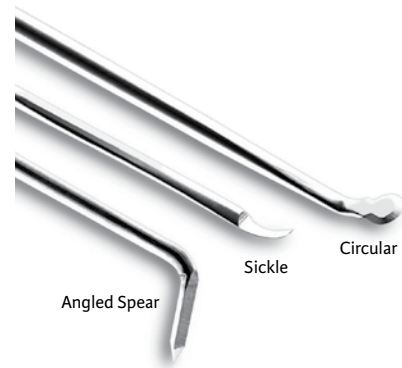

### Blitzer Laryngeal Knife Handle

Catalog #	Description
1422400	6.0mm, Triangular Bite
9622400	Blitzer Laryngeal Knife Handle-Modified



### SPECIALTY SURGICAL PRODUCTS

#### Sataloff Thyroplasty Elevator

Overall length 195mm (7¾"), Double-Ended

Catalog #	Description
3711099	Elevator in 1.0mm Increments, 2.5mm Round Knife



### Oro-Tracheal Laryngeal Injector Set

Allows for controlled placement, delivery, and visualization during vocal fold augmentation

Interchangeable needle cannulae in both angled and curved styles, for direct and indirect injection techniques

Syringe handle accommodates standard insulin slip tip syringes

Catalog #	Description
1650025	Oro-Tracheal Injector
Includes:	
	Syringe Handle
	Curved Needle Cannula, 22cm
	Straight Needle Cannula, 22cm
1650030	Oro-Tracheal Injector Cannula Curved
Includes:	
	Syringe Handle
	Curved Needle Cannula, 22cm
9610200	Oro-Tracheal Injector Cannula Straight
Includes:	
	Syringe Handle
	Straight Needle Cannula
1650050	Oro-Tracheal Laryngeal Injector Needles
	Small, 27 Gauge, 5 pack
	Packaged Sterile Single Use

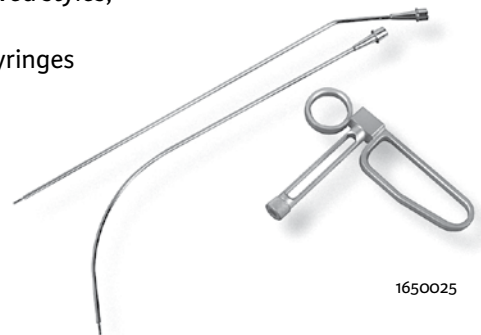

1650025

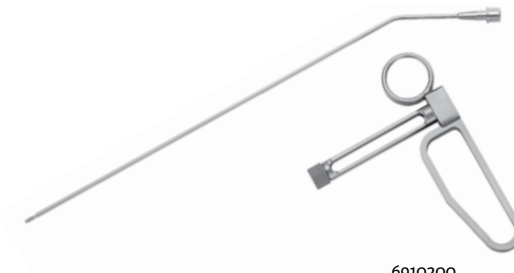

6910200

### Instrument Tray

Working length 92mm (3 3/4")

Catalog #	Description
MCEN136SC	285mm L x 175mm W x 50mm D (11 1/4" L x 7" W x 2" D)

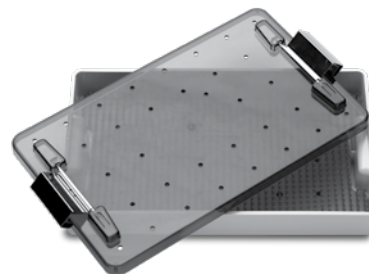

### Lee-Ahn Injection Needle Sheath

Overall length 143mm (5 5/8"), Bayonet

Catalog #	Description
3724397	1.7 x 5.0mm Bulbus Tip, 39.0mm Shaft



### Aston-Daniel Endoscopic Cannula

Working length 128mm (5")

Catalog #	Description
1886300*	4.5mm I.D. x 16.0mm, Angled 110°

\*Not for sale in US

### Daniel Endoscopic Cannula

Working length 118mm (4 5/8")

Catalog #	Description
1886100*	4.5mm I.D., Straight
1886200*	5.5mm I.D., Straight

\*Not for sale in US

### Jackson Alligator Grasping Forceps

Working length 280mm (11")

Catalog #	Description
3734218	4.0 x 22.0mm, Serrated



### Mustard Table

Attaches to the OR table side frame

Catalog #	Description
3734500	Mustard Table
3734510	Mustard Table Adapter



### Laryngoscope Tray

Catalog #	Description
3717023	Instrument Tray, 52.5cm L x 25cm W x 17cm D (20 3/4" L x 9 3/4" W x 6 3/4" D)

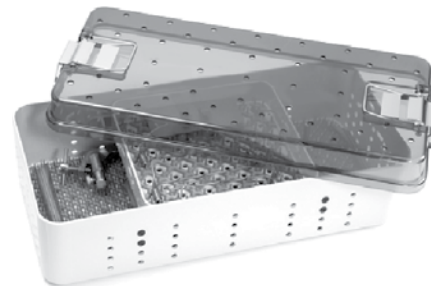

### Instrument Tray, Laryngeal Forceps

Overall length 140mm (5 1/2")

Catalog #	Description
MCL-S36	49.5cm L x 22.5cm W (19 1/2" L x 8 3/4" W)



Instruments not included

INTEGRA<sup>®</sup>  
LIMIT UNCERTAINTY



Integra<sup>®</sup>  
ENT Instrumentation  
Plastic Surgery Instruments

### Castroviejo Caliper

Overall length 86mm (3<sup>3</sup>/<sub>8</sub>"

Catalog #	Description
3740009	0-20.0mm Scale, Straight



### Ruler

Overall length 152mm (6"), Stainless Steel

Catalog #	Description
3740086	Graduated in Millimeters and Inches



**ENDOSCOPIC PLASTIC SURGERY INSTRUMENTS**

**Arcus Marginalis Dissector**

Overall length 255mm (10")

Catalog #	Description
3747004	9.5mm wide Blade



**Forehead Elevator, Half Curved**

Overall length 235mm (9¼")

Catalog #	Description
3747019	7.5mm Curved Blade



**Forehead Grasping Forceps**

Working length 130.0mm (5⅛")

Catalog #	Description
3747017	2.0 x 6.5mm, Serrated, Curved Left
3747031	2.0 x 6.5mm, Serrated, Curved Right

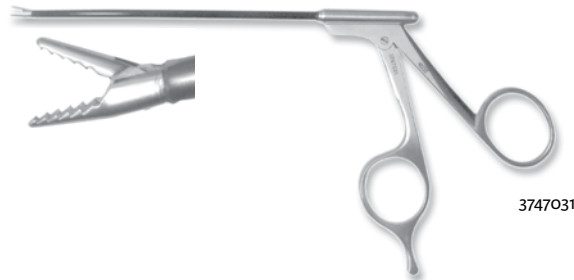

**Frontotemporal Dissector**

Catalog #	Description
3747008	Straight

**Forehead Scissors**

Working Length 5⅛" (130mm)

Catalog #	Description
3747012	Curved Right
3747014	Curved Left



### Forehead Orbital Rim Dissector

Catalog #	Description
3747021	Half Curved

### Forehead Suction Elevator

Working Length 9 1/4" (235mm)

Catalog #	Description
3747025	Quarter Curved

### Parietal Periosteal Elevator

Working length 240mm (9 1/2")

Catalog #	Description
3747007	11.5mm Curved Blade



### Periosteal Spreader

Working length 250mm (9 3/4")

Catalog #	Description
3747003	9.5mm Curved Blade

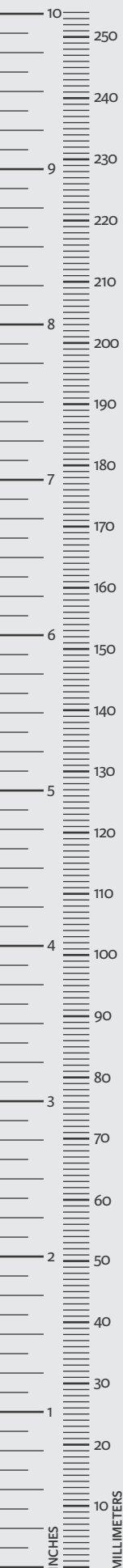



**FORCEPS**

**Adson Dressing Forceps**

Catalog #	Description
3740021	Serrated Jaws, Standard, 120mm (4¾")
3740108	Serrated Jaws, Delicate, 120mm (4¾")
3740024	Serrated Jaws, Delicate, 152mm (6")
3740036	Serrated Jaws, 0.9, Micro, 121mm (4¾")



3740021

**Adson Tissue Forceps, Tungsten-Carbide**

Overall length 121mm (4¾")

Catalog #	Description
3740031	Serrated



### Adson Tissue Forceps

Overall length 120mm (4¾")

Catalog #	Description
3740025	1.2mm, 1 x 2 Teeth, Standard
3740026	0.8mm, 1 x 2 Teeth, Delicate
3740027	1.25mm, 1 x 2 Teeth, Serrated



3740025

### Adson Tissue Forceps, Delicate

Overall length 121mm (4¾")

Catalog #	Description
3740028	2.0mm, 2 x 3 Teeth

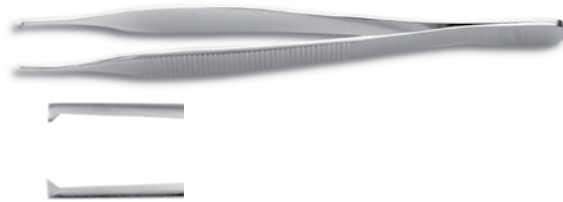

### Bishop-Harmon Dressing Forceps

Overall length 86mm (3⅜")

Catalog #	Description
3740054	Cross-Serrated Tips



### Bishop-Harmon Tissue Forceps

Overall length 86mm (3⅜")

Catalog #	Description
3740051	0.85mm, 1 x 2 Teeth
3740052	1.25mm, 1 x 2 Teeth
3740053	1.0mm, 1 x 2 Teeth, Curved



3740051

3740052

### Brown-Adson Tissue Forceps

Overall length 120mm (4¾")

Catalog #	Description
3740038	8 x 10 Teeth, Angled
3740039	7 x 7 Teeth, Straight

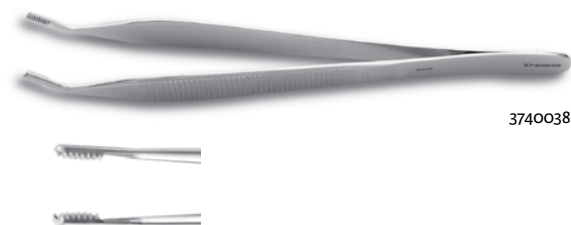

3740038

### Castroviejo Suture Forceps

Overall length 108mm (4¼")

Catalog #	Description
3740057	0.5mm, 1 x 2 Teeth, W/Platform, Wide Handle

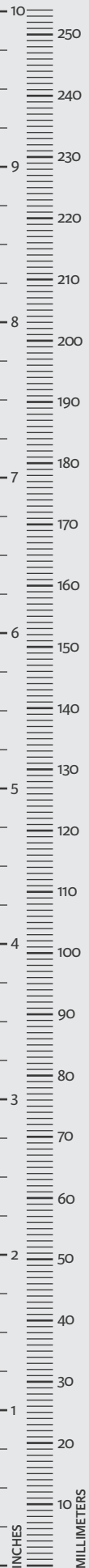

### Cottle Columella Forceps

Overall length 107mm (4¼")

Catalog #	Description
3740067	11.5mm Wide Jaw



### Dressing Forceps

Catalog #	Description
3740012	Serrated, 117mm (4⅝")
3740015	Serrated, 146mm (5¾")



### Graefe Fixation Forceps

Overall length 108mm (4⅛"), W/Lock

Catalog #	Description
3740049	4.0mm Jaws



### Jeweler Forceps

Catalog #	Description
3740068	No. 1, Fine, 117mm (4¾")
3740069	No. 3, Extra Fine, 117mm (4¾")
3740071	No. 5, Extra Fine, 108mm (4¼")
3740072	No. 5A, Fine, 45° Angled, 108mm (4⅛")

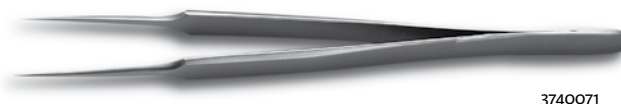

### Potts-Smith Tissue Forceps

Overall length 185mm (7¼")

Catalog #	Description
3740090	1 x 2 Teeth



### Tissue Forceps

Overall length 152mm (6")

Catalog #	Description
3740019	1 x 2 Teeth



**Knife Handle**

Overall length 125mm (4<sup>7</sup>/<sub>8</sub>" )

Catalog #	Description
3740000	No. 3



**Knife Handle**

Overall length 163mm (6<sup>3</sup>/<sub>8</sub>" )

Catalog #	Description
3740002	No. 7



**Knife Handle**

Overall length 142mm (5<sup>3</sup>/<sub>8</sub>" )

Catalog #	Description
3740003	No. 9



**Knife Handle, Corwin**

Overall length 136mm (5.4" )

Catalog #	Description
3740006	Round Knurled Handle



**Rosen Cartilage Knife**

Overall length 195mm (7<sup>3</sup>/<sub>4</sub>" ), Double-Ended

Catalog #	Description
3742000	3.5mm, 45° and 90° Blades

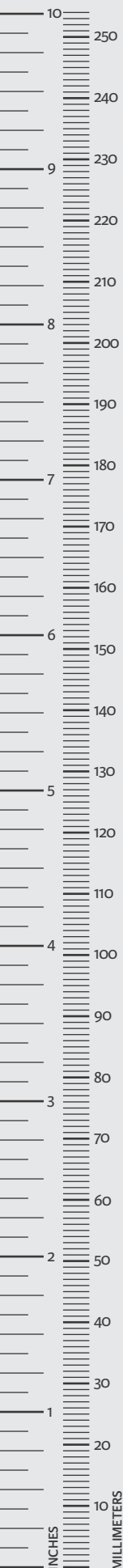

**Brown Needle Holder**

Overall length 132mm (5¼")

Catalog #	Description
3744000	Convex, Fine Serrated



**Castroviejo Needle Holder**

Overall length 135mm (5⅜")

Catalog #	Description
3752008	12.0mm, Straight W/Lock
3752011	12.0mm, Curved W/Lock



3752008

**Crile-Wood Needle Holder**

Overall length 152mm (6")

Catalog #	Description
3744010	17.0mm, Serrated with Grooved Jaws



**Crile-Wood Needle Holder, W/Tungsten-Carbide Jaws**

Catalog #	Description
3744025	14.0mm, Serrated Jaws, 152mm (6")
3744026	17.0mm, Serrated Jaws, 181mm (7¼")



3744025

### Derf Needle Holder

Overall length 121mm (4¾")

Catalog #	Description
3744003	11.5mm, Grooved Jaw



### Halsey Needle Holder, W/Tungsten-Carbide Jaws

Overall length 132mm (5¼")

Catalog #	Description
3744015	Serrated
3744016	Smooth



3744015

### Mayo-Hegar Needle Holder, W/Tungsten-Carbide Jaws

Catalog #	Description
3744030	Serrated Jaws, 160mm (6¼")
3744031	Serrated Jaws, 186mm (7¼")
3744032	Serrated Jaws, 205mm (8")



3744030

### Olsen-Webster Needle Holder/Scissors, Tungsten-Carbide

Overall length 121mm (4¾")

Catalog #	Description
3744019	Delicate Smooth Jaws
3744020	Delicate Serrated Jaws



3744019



**Ryder Needle Holder, Tungsten-Carbide**

Overall length 127mm (5")

Catalog #	Description
3744027	1.0mm, Serrated Jaw



**Webster Needle Holder**

Catalog #	Description
3744001	14.0mm Smooth Jaws, 127mm (5")
3744040	15.5mm Smooth Jaws, 123mm (47/8")



3744001

**Webster Needle Holder, W/Tungsten-Carbide Jaws**

Overall length 130mm (5 1/8")

Catalog #	Description
3744012	14.0mm Smooth Jaws



**PROBES**

**Bowman Lacrimal Probe, Stainless Steel**

Overall length 140mm (5 1/2"), Double-Ended

Catalog #	Description
3740074	Size 0000/000
3740075	Size 00/0
3740076	Size 1/2
3740077	Size 3/4
3740078	Size 5/6
3740079	Size 7/8



3740077

**Baby Metzenbaum Scissors**

Overall length 117mm (4<sup>5</sup>/<sub>8</sub>" )

Lower blade serrated

Catalog #	Description
3741098	Straight
3741099	Curved



3741099

**Brophy Gum and Suture Scissors**

Overall length 144mm (5<sup>5</sup>/<sub>8</sub>" )

Catalog #	Description
3741007	Straight
3741008	Curved



3741008

**Converse Double-Edge Scissors**

Overall length 130mm (5<sup>1</sup>/<sub>4</sub>" )

Catalog #	Description
3741052	Semi-Sharp Outer Edges



**Fomon Dorsal Scissors**

Overall length 146mm (5<sup>1</sup>/<sub>2</sub>" )

One Scissor, One Knife Ground Blades

Catalog #	Description
3741154	Shanks Angled 40° on the Flat





**Forehead Scissors**

Working length 130mm (5 1/8")

Catalog #	Description
3747012	5.0mm, Curved Right
3747014	5.0mm, Curved Left

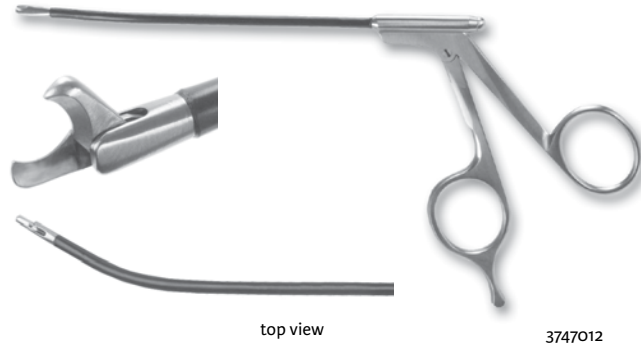

**Freeman Rhytidectomy Scissors**

Overall length 178mm (7"), Flat Blunt Tips

Catalog #	Description
3741054	Curved



**Gorney Plastic Surgery Scissors**

Overall length 187mm (8"), Blunt Tips

Catalog #	Description
3741015	Straight
3741016	Light Curve



**Iris Scissors, Sharp/Sharp**

Catalog #	Description
3741177	Straight, 90mm (3 1/2")
3741178	Straight, 105mm (4 1/8")
3741179	Straight, 116mm (4 5/8")



### Iris Scissors, Sharp/Sharp

Catalog #	Description
3741180	Curved, 89mm (3½")
3741181	Curved, 105mm (4¼")
3741182	Curved, 115mm (4½")

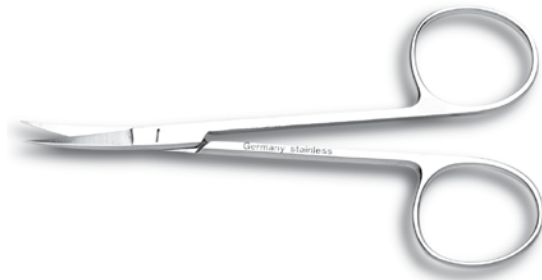

3741181

### Iris Scissors, Sharp/Blunt

Overall length 112mm (4¾")

Catalog #	Description
3741183	Straight, 115mm (4½")
3741184	Curved

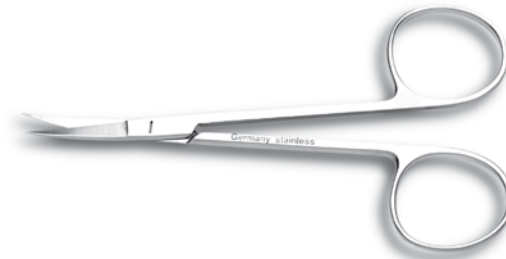

3741184

### Iris Scissors, Large Finger Rings, Sharp/Sharp

Overall length 102mm (4")

Catalog #	Description
3741029	Curved



**Iris Scissors, Sure-Grip (Tungsten Carbide)**

Overall length 114mm (4½")

Catalog #	Description
3741020	Curved
3741021	Straight



3741021

**Iris Scissors, "Supercut"**

Overall length 112mm (4¾")

Catalog #	Description
3741131	Straight
3741132	Curved



3741132

**Joseph Scissors**

Overall length 145mm (5¾")

Catalog #	Description
3741166	Straight
3741048	Curved



3741166

**Joseph Scissors, Double Edge**

Overall length 144mm (5⅝")

Catalog #	Description
3741049	Curved



**Kaye Dissecting Scissors, Fine**

Overall length 106mm (4 1/8")

Catalog #	Description
3741010	Curved, Serrated Blades



**Kaye Facelift Scissors**

Overall length 147mm (5 3/4")

Semi-sharp outer edges

Catalog #	Description
3741011	Curved, Serrated Blades



**Kaye Facelift Scissors, W/Tungsten-Carbide Blades**

Semi-sharp outer edges

Catalog #	Description
3741017	Curved, Serrated Blades, 114mm (4 1/2")
3741019	Curved, Serrated Blades, 178mm (7")



3741019

**Knapp Strabismus Scissors**

Overall length 118mm (4 5/8")

Catalog #	Description
3713015	Straight
3713016	Curved



3713015

### Lahey Dissecting Scissors

Overall length 146mm (5¾")

Catalog #	Description
3741002	Straight
3741003	Curved



3741003

### Lister Bandage Scissors

Catalog #	Description
3741129	Overall length 143mm (5⅝")



### Littler Suture Carrying Scissors

Overall length 118mm (4⅝")

Catalog #	Description
3741046	Curved



### Mayo Scissors, Beveled Blades

Catalog #	Description
3741187	Straight, 145mm (5¾")
3741160	Curved, 143mm (5½")
3741079	Curved, 170mm (6¾")



3741079

**Mayo Scissors, W/Tungsten-Carbide Blades**  
Round Blades

Catalog #	Description
3741080	Curved, 147mm (5¾")
3741081	Straight, 148mm (5¾")
3741082	Curved, 171mm (6¾")
3741083	Straight, 170mm (6¾")



3741080

**Metzenbaum Scissors, Delicate**  
Overall length 133mm (5¼")

Catalog #	Description
3741076	Curved



**Metzenbaum Scissors, Delicate**  
Overall length 177mm (7")

Catalog #	Description
3741077	Curved



**Metzenbaum Scissors, W/Tungsten-Carbide Blades**

Catalog #	Description
3741065	Curved, Regular, 146mm (5¾")
3741066	Straight, Regular, 146mm (5¾")
3741067	Curved, Regular, 180mm (7")
3741068	Straight, Regular, 178mm (7")
3741071	Curved, Delicate, 146mm (5¾")
3741075	Curved, Regular, 230mm (9")



3741066

**Operating Scissors**

Overall length 146mm (5¾")

Catalog #	Description
3741057	Straight, Sharp/Sharp
3741060	Straight, Sharp/Blunt



3741057



3741060

**Plastic Surgery Scissors**

Overall length 119mm (4⅝")

Catalog #	Description
3741001	Curved, Sharp/Sharp

**Scissors, Spring Handle**

Overall length 149mm (5⅞")

Catalog #	Description
3753007	Curved, 19.0mm Serrated Blades
3753008	Straight, 19.0mm Serrated Blades



3753007

### Stevens Tenotomy Scissors

Overall length 93mm (3<sup>5</sup>/<sub>8</sub>" ), Blunt Tips

Catalog #	Description
3741035	Straight
3741036	Curved



3741036

### Stevens Stitch Scissors

Overall length 102mm (4" ), Sharp Tips

Catalog #	Description
3741034	Curved



### Stevens Stitch Scissors, Ribbon Type

Overall length 98mm (3<sup>7</sup>/<sub>8</sub>" )

Catalog #	Description
3741032	Light Curved, Needle Points
3741033	Light Curved, Very Sharp Tips



3741032

## WIRE CUTTERS

### Guilford-Wright Wire Cutting Scissors

Overall length 89mm (3<sup>3</sup>/<sub>8</sub>" )

Catalog #	Description
3722025	Serrated Blades

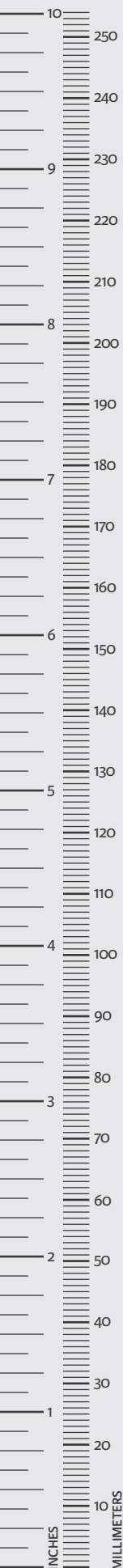



**Universal Wire Suture Scissors**

Overall length 122mm (4¾")

Catalog #	Description
3741156	Angled, One Blade Serrated



**Becker Wire Scissors, Tungsten Carbide**

Overall length 120mm (4¾")

Catalog #	Description
713T	Angled, One Blade Serrated



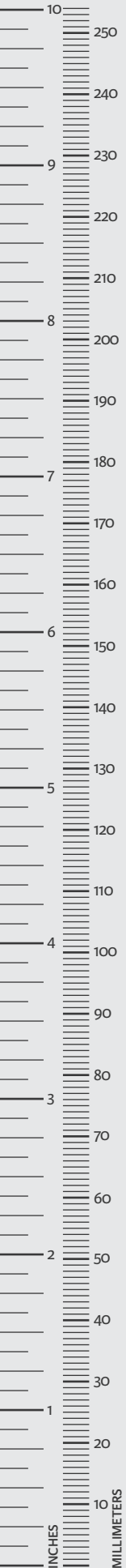

INTEGRA<sup>®</sup>  
LIMIT UNCERTAINTY



Integra<sup>®</sup>  
ENT Instrumentation  
General Instruments

### Adson Hemostatic Forceps

Catalog #	Description
3755143	Straight, 186mm (7¼")
3755147	Curved, Delicate, 181mm (7⅛")



3755143

### Allis Tissue Forceps

Catalog #	Description
3755160	3 x 4 Teeth, 140mm (5½")
3755161	4 x 5 Teeth, 152mm (6")
3755162	5 x 6 Teeth, 152mm (6")



3755161

### Babcock Tissue Forceps

Overall length 165mm, (6½")

Catalog #	Description
3755100	4.7mm I.D. Jaws



### Crile Hemostatic Forceps

Catalog #	Description
3755116	Straight, 145mm (5¾")
3755117	Curved, 142mm (5⅝")



3755117

### Halstead Mosquito Forceps

Catalog #	Description
3755101	Straight, 121mm (4¾")
3755102	Curved, 125mm (4⅞")



3755101

**Hartman Mosquito Forceps**

Overall length 100mm (3<sup>7</sup>/<sub>8</sub>" )

Catalog #	Description
3755110	Straight
3755111	Curved



3755111

**Kelly Artery Forceps**

Overall length 145mm (5<sup>3</sup>/<sub>4</sub>" )

Catalog #	Description
3755114	Straight
3755115	Curved



3755115

**Micro Mosquito Forceps**

Overall length 122mm (4<sup>3</sup>/<sub>4</sub>" )

Catalog #	Description
3755106	Straight
3755107	Curved



3755106

**Mixer Forceps, Baby**

Overall length 138mm (5<sup>3</sup>/<sub>8</sub>" )

Catalog #	Description
3755129	Curved



**Rochester-Ocshner Artery Forceps**

Overall length 163mm (6<sup>1</sup>/<sub>2</sub>" )

Catalog #	Description
3755138	Straight, 1 x 2 Teeth



### Rochester-Pean Artery Forceps

Overall length 169mm, (6¾")

Catalog #	Description
3755133	Straight
3755136	Curved, Delicate Jaws



3755133

### SPONGE/TOWEL FORCEPS

#### Foerster Sponge Forceps

Overall length 180mm (7")

Catalog #	Description
3755152	Straight, Serrated Jaw



#### Backhaus Towel Forceps

Catalog #	Description
3755000	Overall Length 89mm (3½")
3755001	Overall Length 132mm (5¼")



3755001

#### Roeder Towel Forceps

Catalog #	Description
3755002	Overall Length 135mm (5⅜")

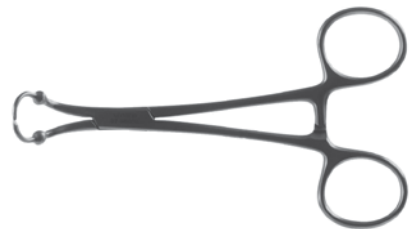

#### Non-Perforating Towel Forceps

Catalog #	Description
3755010	Overall Length 130mm (5⅛")

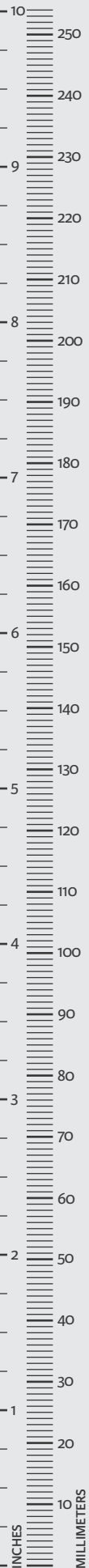

## INSTRUMENT TRAYS

### One-Level Tray

**Catalog #**      **Description**

**3717012**      38cm L x 25.5cm W x 7.4cm D  
(15" L x 10" W x 2<sup>7</sup>/<sub>8</sub>" D)"

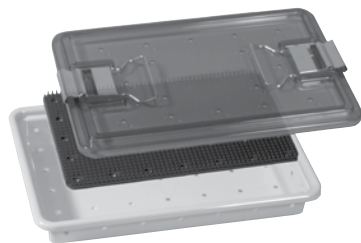

3717012

**3717002**      52cm L x 25cm W x 2.8cm D  
(20<sup>1</sup>/<sub>2</sub>" L x 9<sup>3</sup>/<sub>4</sub>" W x 1<sup>1</sup>/<sub>8</sub>" D)"

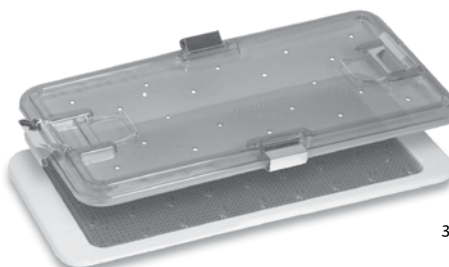

3717002

**MCEN136SC**      285mm L x 175mm W x 50mm D  
(11<sup>1</sup>/<sub>4</sub>" L x 7" W x 2" D)"

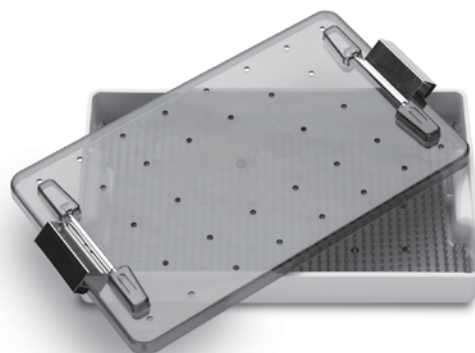

MCEN136SC

### Small Instrument Tray

**Catalog #**      **Description**

**MCSKoSC**      19.8cm L x 11.0cm W x 2.2cm D  
(7<sup>3</sup>/<sub>4</sub>" L x 7" W x 7<sup>8</sup>/<sub>8</sub>" D)"

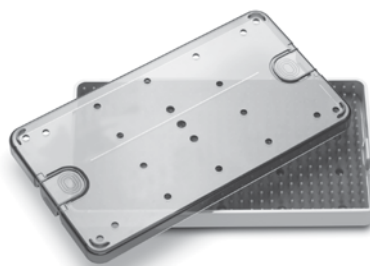



## Two-Level Tray

**Catalog #**      **Description**

**MCOS1oSC**      38.5cm L x 25.6cm W x 12.8cm D  
15¼" L x 10" W x 5" D



MCOS1oSC

**3717000**      Upper Insert with Silicone Brackets  
53.0cm L x 25.5cm W x 14.0cm D  
20¾" L x 10" W x 5½" D



3717000

**3717006**      Upper Insert with Silicone Brackets, Base with  
Silicone Finger Mat  
53.0cm L x 25.5cm W x 14.0cm D  
20¾" L x 10" W x 5½" D



3717006

**MCOHoSC**      Includes 6 Silicone Straps, 12 Snap-In Posts,  
and Post Removal Tool  
54.6cm L x 25.9cm W x 12cm D  
21½" L x 10¼" W x 4¾" D

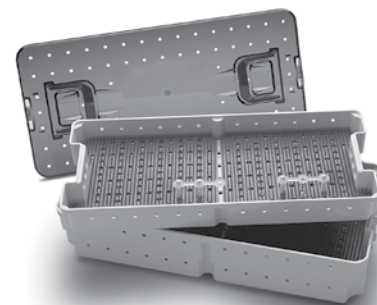

MCOHoSC





### Three-Level Tray

Catalog #	Description
3717001	53cm L x 25.5cm W x 15cm D 20¾" L x 10" W x 5⅞" D



3717001

### Three-Level Modular Tray

Catalog #	Description
3717011	52.8cm L x 25cm W x 12.3cm D 20¾" L x 9¾" W x 4⅞" D



3717011

### Pick Tray, Plastic

Catalog #	Description
3717022	Accommodates 16 Picks 21cm L x 12.3cm W x 3.6cm D 8¼" L x 4⅞" W x 1⅜" D

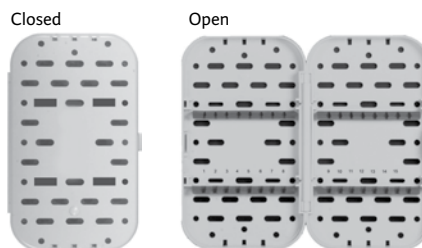

3717022

## Laryngoscope Tray

Catalog #	Description
3717023	52.5cm L x 25cm W x 17cm D 20¾" L x 9¾" W x 6¾" D Holds 2 Laryngoscopes, 2 Fiberoptic Cables, Suspension Apparatus, and Chest Plate



3717023

## Otology Tray Set

Catalog #	Description
-----------	-------------

**Set includes:**

3717026	Multi-Level Modular Otology Tray, Metal 52.7cm L x 25.4cm W x 18.2cm D 20¾" L x 10" W x 7¼" D Upper Insert with Silicone Brackets, Base with Silicone Finger Mat 53.0cm L x 25.5cm W x 14.0cm D 9¾" L x 8¾" W x 1¾" D
---------	---

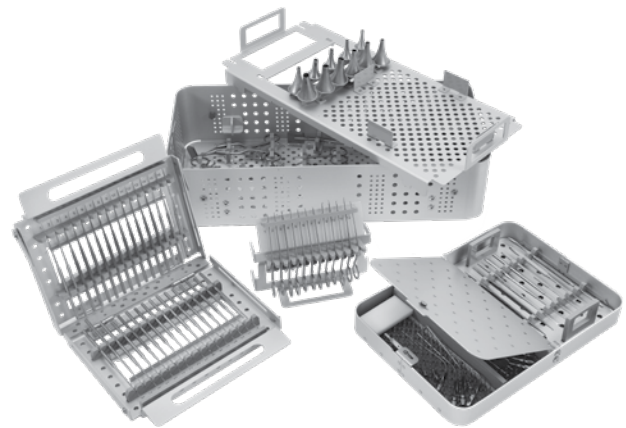

3717025	Pick Tray, Metal Fits Inside Otology Tray; Holds up to 32 Picks 24.8 cm L x 22.1 cm W x 4.5 cm D 9¾" L x 9¾" W x 1¾" D
---------	---



3717025

## Mustard Table

Easily attaches to OR table sideframe  
Facilitates surgeon control during suspension laryngoscopy  
Edge slots permit adjustment and disconnection of mouth-gag  
removal in emergency situations

Catalog #	Description
3734500	Mustard Table
3734510	Mustard Table Adapter



3734500



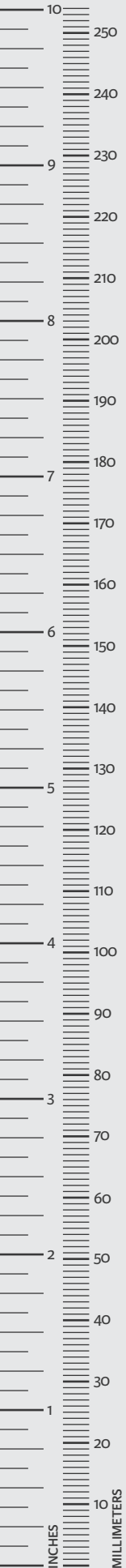

**INTEGRA**<sup>®</sup>  
LIMIT UNCERTAINTY



# Integra<sup>®</sup> MicroFrance<sup>®</sup>

## General Instrumentation

## CURETTES

### Volkman Currettes

Overall length 170mm (6¾")

Catalog #	Description
CP302-4	Size 000, 4.0mm
CP302-5	Size 00, 5.0mm
CP302-6	Size 0, 6.0mm
CP302-8	Size 2, 9.0mm



CP302-6

## ELEVATORS

### Freer Septum Elevator

Overall length 186mm (7¼"), Double-Ended

Catalog #	Description
CP611	5.2 x 5.5mm Wide Blades

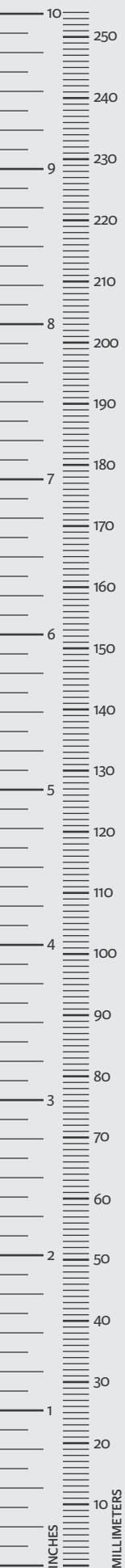

## BIPOLAR FORCEPS/CABLES

### Adson Bipolar Forceps

Catalog #	Description
CP604BR	1.4mm, Serrated, 120mm (4 <sup>3</sup> / <sub>4</sub> " )
CP605BR	1.4mm, 1 x 2 Teeth, 150mm (5 <sup>7</sup> / <sub>8</sub> " )



CP604BR

### Bipolar Coagulating Forceps, Insulated

Catalog #	Description
CP392-1R	1.4 x 8.0mm, Straight, 110mm (4 <sup>3</sup> / <sub>8</sub> " )
CP392-2R	1.5 x 9.5mm, Straight, 160mm (6 <sup>1</sup> / <sub>4</sub> " )
CP392-3R	1.6 x 9.5mm, Straight, 200mm (7 <sup>3</sup> / <sub>4</sub> " )
CP392-8R	1.0 x 9.0mm, Angled, 160mm (6 <sup>1</sup> / <sub>4</sub> " )
CP392-10R	1.0 x 9.0mm, Angled, 200mm (7 <sup>3</sup> / <sub>4</sub> " )
CP392-5R	1.4 x 9.0mm, Bayonet, 200mm (7 <sup>3</sup> / <sub>4</sub> " )
CP392-9R	1.4 x 9.0mm, Angled, Bayonet, 200mm (7 <sup>3</sup> / <sub>4</sub> " )
CP392-14R	1.4 x 7.0mm, Acute Curve, 190mm (7 <sup>1</sup> / <sub>2</sub> " )



CP392-1R



CP392-2R



CP392-8R



CP392-5R

### Magnan Bipolar Forceps

Overall length 203mm (8")

Catalog #	Description
CP392BI	1.0 x 5.0mm, Bayonet, Angled Down
CP392BS	1.0 x 5.0mm, Bayonet, Angled Up



CP392BI

### Bipolar Cables

Catalog #	Description
CP393	4.5m (14 <sup>1</sup> - <sup>3</sup> / <sub>4</sub> " ), Universal Cable
CP393-2	4.5m (14 <sup>1</sup> - <sup>3</sup> / <sub>4</sub> " ), ValleyLab Cable
CP393-3	4.5m (14 <sup>1</sup> - <sup>3</sup> / <sub>4</sub> " ), Erbe Cable
CP393-4	4.5m (14 <sup>1</sup> - <sup>3</sup> / <sub>4</sub> " ), Martin Cable



CP393

## HEMOSTATIC TYPE FORCEPS

### Halstead Mosquito Forceps

Catalog #	Description
P761-2	Curved, Serrated, 95mm (3¾")
P761-5	Straight, Serrated, 127mm (5")
P761-6	Curved, Serrated, 125mm (5")
P761-7	Straight, 1 x 2 Teeth, 127mm (5")
P761-8	Curved, 1 x 2 Teeth, 127mm (5")

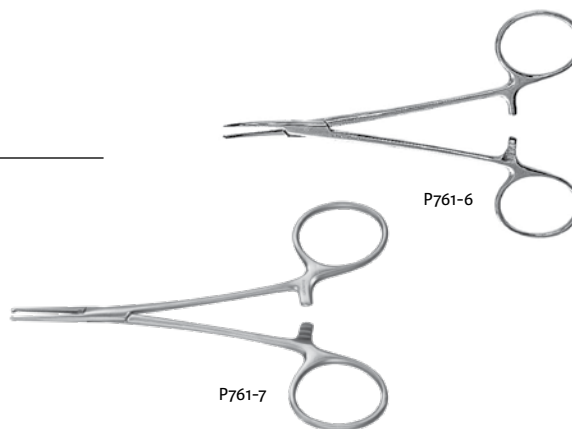

### Halstead Micro Mosquito Forceps

Overall length 120mm (4¾")

Catalog #	Description
P761T6	0.5mm, Curved, Serrated



### Kelly Artery Forceps

Catalog #	Description
P762-2	Curved, 144mm (5⅝")
P762-4	Curved, 161mm (6¼")

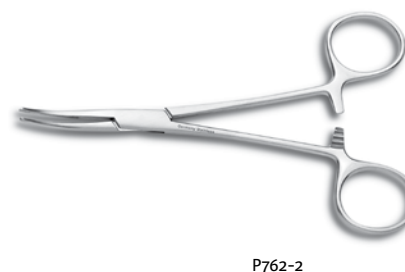



## HEMOSTATIC TYPE FORCEPS

### Kocher Forceps

Catalog #	Description
P764-1	Straight, 1 x 2 Teeth, 135mm (5 <sup>3</sup> / <sub>8</sub> "
P764-7	Straight, 1 x 2 Teeth, 164mm (6 <sup>1</sup> / <sub>2</sub> "
P764-11	Straight, 1 x 2 Teeth, 184mm (7 <sup>1</sup> / <sub>4</sub> "
P764-3	Straight, Delicate, 1 x 2 Teeth, 140mm (5 <sup>1</sup> / <sub>2</sub> "
P764-5	Straight, Serrated, 158mm (6 <sup>1</sup> / <sub>4</sub> "



P764-7

### Leriche Hemostatic Forceps

Overall length 150mm (5<sup>7</sup>/<sub>8</sub>"

Catalog #	Description
7867-1	Straight, Serrated
7867-2	Curved, Serrated
7867-3	Straight, 1 x 2 Teeth
7867-4	Curved, 1 x 2 Teeth



7867-2

### Peaen Forceps

Catalog #	Description
P765-14	Straight, Serrated, 140mm (5 <sup>1</sup> / <sub>2</sub> "
P765-16	Straight, Serrated, 159mm (6 <sup>1</sup> / <sub>4</sub> "



P765-16

### Terrier Forceps

Overall length 125mm (4<sup>7</sup>/<sub>8</sub>"

Catalog #	Description
P769	5.5 x 17.0mm, Straight, Serrated Jaw



## DRESSING AND TISSUE FORCEPS

### Adson Dressing/Tissue Forceps

Catalog #	Description
CP604	1.5mm, Serrated, 120mm (4 <sup>3</sup> / <sub>4</sub> " )
CP604-15	1.5mm, Serrated, 150mm (5 <sup>7</sup> / <sub>8</sub> " )
CP605	1.5mm, 1 x 2 Teeth, 120mm (4 <sup>3</sup> / <sub>4</sub> " )
CP605-15	1.5mm, 1 x 2 Teeth, 150mm (5 <sup>7</sup> / <sub>8</sub> " )

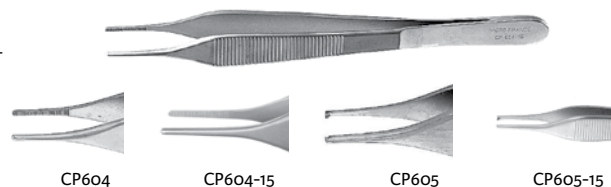

### Brown-Adson Tissue Forceps

Catalog #	Description
CP606	2.0mm, 7 x 7 Teeth, Stainless, 124mm (4 <sup>7</sup> / <sub>8</sub> " )
CP606-15	2.5mm, 7 x 7 Teeth, Stainless, 151mm (6" )
CP606A	1.5mm, Serrated, Tungsten Carbide, 124mm (4 <sup>7</sup> / <sub>8</sub> " )



### Atraumatic Dissecting Forceps

Overall length 110mm (4<sup>3</sup>/<sub>8</sub>" )

Catalog #	Description
CP332	1.4mm, Atraumatic Teeth



### Barraya Dissecting Forceps

Catalog #	Description
CP933-14	1 x 2 Teeth, Serrated, 140mm (5 <sup>1</sup> / <sub>2</sub> " )
CP933-16	1 x 2 Teeth, Serrated, 160mm (6 <sup>1</sup> / <sub>4</sub> " )
CP933-18	1 x 2 Teeth, Serrated, 180mm (7" )



## DRESSING AND TISSUE FORCEPS

### Claoue Dissecting Forceps

Overall length 162mm (6½")

Catalog #	Description
CP401	5 x 6 Teeth



### Dissecting Forceps

Catalog #	Description
CP406	1.2mm, 1 x 2 Teeth, 121mm (4¾")
CP407	1.2mm, 1 x 2 Teeth, 151mm (6")
CP409	1.2mm, 1 x 2 Teeth, 181mm (7¼")
CP982	1.7mm, 1 x 2 Teeth, 139mm (5½")
CP414	1.2mm, Serrated, 121mm (4¾")
CP415	1.2mm, Serrated, 149mm (5⅞")



CP407



CP415

### Dressing Forceps-Serrated

Catalog #	Description
7831A-12	2.0mm, Straight, 120mm (4¾")
7831A-15	2.0mm, Straight, 154mm (6")
7831A-18	2.0mm, Straight, 177mm (7")
7831A-20	2.0mm, Straight, 212mm (8¼")
7832	2.0mm, Curved, 212mm (8¼")



7831A-15



7831A-18

### Tissue Forceps-1 x 2 Teeth

Catalog #	Description
7833A-12	2.0mm, Straight, 120mm (4¾")
7833A-15	2.0mm, Straight, 153mm (6")
7833A-18	2.0mm, Straight, 177mm (7")
7833A-20	2.0mm, Straight, 211mm (8¼")
7834	1.0mm, Curved, 210mm (8¼")



7833A-18

### McIndoe Forceps

Catalog #	Description
CP934-1	Serrated, 140mm (5½")
CP934	1 x 2 Teeth, 138mm (5¾")
CP936	1 x 2 Teeth, 180mm (7")



CP934

### Tissue Forceps, Atraumatic Teeth

Catalog #	Description
CP400-1	5x6 Teeth, 110mm (4¾")
CP400	5x6 Teeth, 140mm (5½")
CP400-2	5x6 Teeth, 182mm (7¼")



CP400

### Precelli Dissecting Forceps

Overall length 150mm (5⅞")

Catalog #	Description
CP345	0.9mm, Serrated, Angled
CP345-1	1.6mm, Serrated, Angled



CP345

### Real Tissue Forceps

Overall length 150mm (5⅞")

Catalog #	Description
CP420	1.25mm Tip, 1 x 2 Teeth

### Adson-Tubiana Forceps, Delicate

Overall length 120mm (4¾")

Catalog #	Description
M832	0.8mm, Serrated
M833	1.0mm, 1 x 2 Teeth
M801	1.0mm, 1 x 2 Teeth, With Platform



M832

## CARDIOVASCULAR TISSUE FORCEPS

### DeBakey-Diethrich Vascular Tissue Forceps

Catalog #	Description
CP988-15	1.7mm, 150mm (5 <sup>7</sup> / <sub>8</sub> " )
CP988-18	1.7mm, 180mm (7" )
CP988-20	1.7mm, 200mm (7 <sup>3</sup> / <sub>4</sub> " )

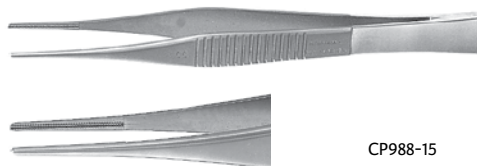

CP988-15

## INTESTINAL TISSUE FORCEPS

### Allis Haemostatic Forceps

Overall length 154mm (6" )

Catalog #	Description
P768-14	3 x 4 Teeth



## TOWEL FORCEPS

### Backhaus Towel Forceps

Catalog #	Description
P766-12	Overall length 126mm (5" )



### Ombredanne Towel Forceps

Catalog #	Description
P771	Overall length 141mm (5 <sup>1</sup> / <sub>2</sub> " )



## SUTURE AND FIXATION FORCEPS

### Castroviejo Forceps

Overall length 110mm (4<sup>3</sup>/<sub>4</sub>" )

Catalog #	Description
-----------	-------------

CP37	0.9mm
------	-------

CP938-1	0.9mm
---------	-------



CP37

## MISCELLANEOUS FORCEPS

### Heart Tip Forceps

Overall length 162mm (6<sup>3</sup>/<sub>8</sub>" )

Catalog #	Description
-----------	-------------

P770	0.9mm, Narrow Handle
------	----------------------



### Martel Flap Grasping Forceps

Overall length 132mm (5<sup>1</sup>/<sub>4</sub>" )

Catalog #	Description
-----------	-------------

P763	4.0 x 16.3mm, with Teeth
------	--------------------------



## MONOPOLAR FORCEPS/CABLES

### Adson Monopolar Forceps

Overall length 150mm (5<sup>7</sup>/<sub>8</sub>" )

Catalog #	Description
-----------	-------------

CP604M	1.2mm, Serrated
--------	-----------------

CP605M	1.2mm, 1 x 2 Teeth
--------	--------------------



CP605M

### Monopolar Ball Tip Coagulator

Overall length 128mm (5")

Catalog #	Description
7882*	1.9mm Ball Tip

\*Not for sale in US



### Monopolar Coagulating Forceps, Insulated

Catalog #	Description
CP390-1	1.2 x 7.5mm, Straight, 138mm (5 3/8")
CP390-2	1.4 x 9.5mm, Straight, 190mm (7 1/2")
CP390-3	1.5 x 9.5mm, Straight, 231mm (9")
CP390L26	1.5 x 9.5mm, Straight, 291mm (11 1/2")
CP390-5	1.5 x 9.5mm, Angled, 228mm (9")
CP390-7	1.5 x 9.5mm, Bayonet, 230mm (9")
CP390-8	1.4 x 9.5mm, W/Teeth, 190mm (7 1/2")



CP390-3



CP390-5



CP390-7

### Monopolar Cables

Catalog #	Description
CP391	1.8m, Cable
CP391-3	3.0m, Cable
CP391-4	4.5m, Cable
CP391E	3.5m, Erbe Cable
CP391M	3.5m, Martin Cable
CP391V	3.5m, ValleyLab Cable

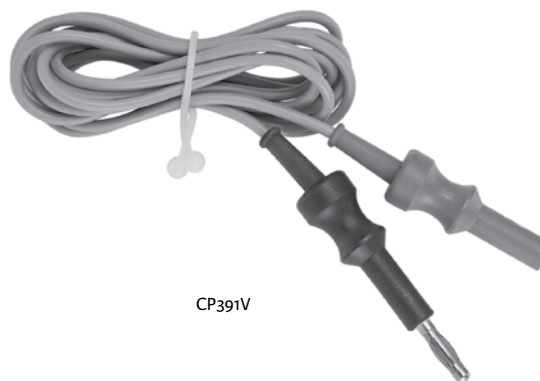

CP391V

### Barraquer Needle Holder

Catalog #	Description
MCM1R	2.0 x 9.0mm, Smooth, 141mm (5½")



### Crile-Wood Needle Holder

Tungsten-Carbide Jaws

Catalog #	Description
702T	151mm (6")
714T	145mm (5¾")
720T	203mm (8")



702T



714T

### Halsey Needle Holder

Tungsten-Carbide Jaws

Overall length 131mm (5⅛")

Catalog #	Description
703T	Serrated
704T	Smooth



703T

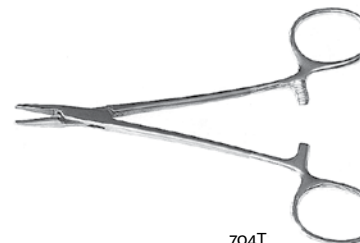

704T



### O'Brien Needle Holder

Catalog #	Description
MCM12R	Curved, 139mm (5½")



### Mayo Hegar Needle Holder

Tungsten-Carbide Jaws

Catalog #	Description
701T	Smooth Jaw, 178mm (7")



### Stratte Needle Holder

Tungsten-Carbide Jaws

Catalog #	Description
7945T	Double Curved, 209mm (8¼")

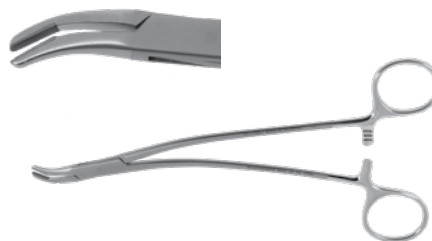

### Desmarres Retractors

Overall length 137mm (5<sup>3</sup>/<sub>8</sub>" )

Catalog #	Description
CP822-10	Size 0, 10.0mm
CP822-12	Size 1, 12.0mm
CP822-14	Size 2, 14.0mm



CP822-12

### Farabeuf Retractors

Catalog #	Description
7768*	Small Blade, 122mm (4 <sup>3</sup> / <sub>4</sub> " ), Set of 2
7768-1*	Large Blade, 148mm (5 <sup>7</sup> / <sub>8</sub> " ), Set of 2



7768-1

\*Not for sale in US

### Ribbon Retractors-Malleable

Overall length 212mm (8<sup>1</sup>/<sub>4</sub>" )

Catalog #	Description
CP818-8	8.0mm Wide
CP818-10	10.0mm Wide
CP818-12	12.0mm Wide
CP818-15	15.0mm Wide
CP818-20	20.0mm Wide



CP818-15



CP818-8

### Senn-Miller Retractors

Overall length 162mm (6<sup>3</sup>/<sub>8</sub>" )

Catalog #	Description
CP609	3-Prong Sharp - 7.0 x 20.0mm Blade

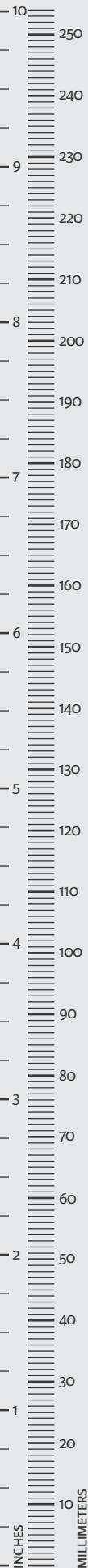

## SCISSORS

### Becker Wire Scissors, Tungsten Carbide

Overall length 120mm (4¾")

Catalog #	Description
713T	Angled, One Blade Serrated



### Cartilage Scissors

Catalog #	Description
CP350	Straight, 185mm (7¼")



### Converse Scissors

Catalog #	Description
CP348	Angled, 97mm (3⅞")



### Cottle Scissors

Catalog #	Description
CP614	Straight Blades, Angled Handles

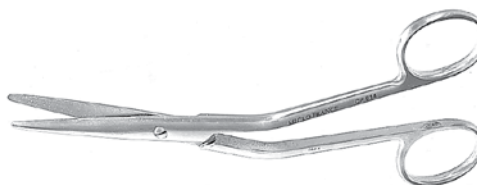

### Fox Scissors

Overall length 115mm (4½")

Catalog #	Description
CP358	Straight, Sharp-Sharp
CP358A	Curved, Sharp-Sharp



CP358A

### Heymann-Klossek Scissors

Overall length 177mm (7")

Catalog #	Description
CP615-1	36.0mm, Serrated Blades



### Joseph Scissors

Overall length 150mm (5 7/8")

Catalog #	Description
CP355	Straight
CP355A	Curved
CP355C	Curved, Heavy Pattern



CP355

### Mayo Scissors, Beveled Blade

Catalog #	Description
CP352	Straight, 145mm (5 3/4")
CP352-1	Curved, 145mm (5 3/4")
CP352-2	Straight, 172mm (6 3/4")
CP352-3	Curved, 172mm (6 3/4")



CP352

CP352-1

### Matzenbaum Scissors, Delicate

Catalog #	Description
CP931	Straight, 145mm (5 3/4")
CP931-1	Curved, 145mm (5 3/4")
CP931-3	Curved, 180mm (7")
CP931-5	Curved, 203mm (8")



CP931-1

CP931

### Metzenbaum Scissors-Standard

Catalog #	Description
CP351-6	Straight, 115mm (4½")
CP351-7	Curved, 115mm (4½")
CP351-2	Straight, 150mm (5⅞")
CP351-3	Curved, 150mm (5⅞")
CP351-1	Curved, 180mm (7")
CP351-5	Curved, 200mm (7¾")



CP351-3

### Operating Scissors

Overall length 125mm (4⅞")

Catalog #	Description
CP354	Straight, Sharp/Sharp
CP354A	Curved, Sharp/Sharp



CP354A

CP354

### Pellegrini Dorsal Scissors

Overall length 151mm (6")

Catalog #	Description
CP359	Angled Handles



### Ragnell Undermining Scissors

Flat Tip Blades

Catalog #	Description
CP616-13	Curved, 135mm (5⅜")
CP616-15	Curved, 150mm (5⅞")



CP616-13



CP616-15

### Scissors, Saber Back

Overall length 170mm (6¾")

Catalog #	Description
CP914	Curved



### Shea Vein Graft Scissors

Flat Dissecting Tips

Catalog #	Description
CP637	Curved, 120mm (4¾")



### Stevens Tenotomy Scissors

Overall length 115mm (4½")

Catalog #	Description
CP922A	Curved



### Streiff Scissors

Overall length 108mm (4¼")

Catalog #	Description
CP16	Straight
CP16-1	Curved



## MISCELLANEOUS

### Chouard Ring

Catalog #	Description
7783-12	For Disposable Syringe, 2/Pkg



### Grooved Director

Overall length 144mm (5⅝")

Catalog #	Description
7839	Plain Point

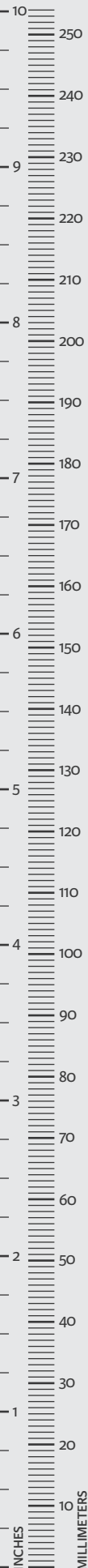

### ENT 5 cc Syringe with Luer-Lock

High pressure, Autoclavable

Catalog #	Description
7779MF-5CC	5cc Graduated Scale
7779MF-1	Accessory, 5.0mm White Sealing Cap
7779MF-2	Accessory, 3.0mm Gray Sealing Cap
7779MF-3	Accessory, 9.0mm Replacement Tube
7779MF-4	Accessory, Replacement Luer Tip



7779MF-5CC



7779MF-3

### Kidney Bowl

Catalog #	Description
7875*	Stainless Steel

\*Not for sale in US



### Stainless Steel Cups

Catalog #	Description
7876-60*	60mm
7876-80*	80mm
7876-100*	100mm
7876-120*	120mm
7876-160*	160mm

\*Not for sale in US



7876-100

### Silicone Mat

Catalog #	Description
MCM25-3*	20.8cm L x 12.6cm W x 2.05cm D 8¼" L x 5" W x ¾" D

\*Not for sale in US

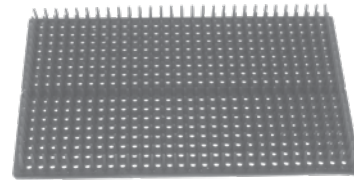

### Stainless Steel Plate

Catalog #	Description
7872-24*	24.0cm L x 18.0cm W (9½" x 7")

\*Not for sale in US



### Stainless Steel Trays

Catalog #	Description
7874MF-22	240mm L x 105mm W x 45mm D 9½" L x 4⅛" W x 1¾" D
7874MF-25	267mm L x 157mm W x 65mm D 10½" L x 6¼" W x 2½" D
7874MF-34	365mm L x 208mm W x 85mm D 14¼" L x 4⅞" W x 1¾" D
7874MF-40	435mm L x 205mm W x 95mm D 17¼" L x 8" W x 3¼" D

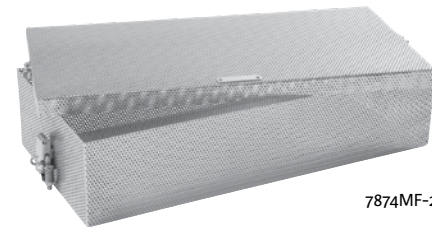

7874MF-25

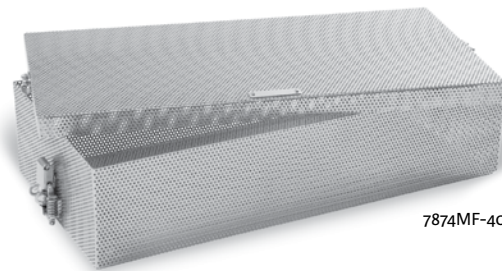

7874MF-40

### Suction Irrigator

Catalog #	Description
MCM10-0-5	0.9 x 6.0mm Tip, 32mm (1¼")
MCM10-1-0	1.45 x 6.0mm Tip, 32mm (1¼")



MCM10-0-5



**INTEGRA**<sup>®</sup>  
LIMIT UNCERTAINTY



# Integra<sup>®</sup> MicroFrance<sup>®</sup>

## General Throat Instruments

### Blondiau Bone Curette

Catalog #	Description
7812	15.3 x 20.5mm Cup, 234mm (9 1/4")



### Lermoyer Adenoid Curette

Overall length 233mm (9 1/4")

Catalog #	Description
7829-10	10.0mm Blade
7829-13	13.0mm Blade
7829-16	16.0mm Blade
7829-19	19.0mm Blade



7829-13

### Lima Bone Curette

Catalog #	Description
7774	4.2mm Cup, 257mm (10")



### Moure Adenoid Curette without Basket

Overall length 222mm (8 3/4")

Catalog #	Description
7828-1-10	10.0mm Blade
7828-1-13	13.0mm Blade
7828-1-16	16.0mm Blade
7828-1-19	19.0mm Blade



7828-1-13

### Moure Adenoid Curette with Basket

Overall length 222mm (8 3/4")

Catalog #	Description
7828-10	10.5mm Blade
7828-13	13.5mm Blade
7828-16	16.0mm Blade
7828-19	19.5mm Blade



7828-10

**Carpenter Dissector/Elevator**

Overall length 228mm (9"), Double-Ended

Catalog #	Description
7815	Elevator, 3.8 x 30.0mm Dissector, 10.0 x 25.0mm



**Henke Double-Ended Dissector**

Overall length 210mm (8¼")

Catalog #	Description
7906	3.9 x 14.0mm and 11.8 x 26.0mm

**Hurd Elevator/Pillar Retractor**

Overall length 223mm (8¾"), Double-Ended

Catalog #	Description
7814	Dissector, 8.0mm Retractor, 13.0mm



**Hurd Elevator/Pillar Retractor, Coated**

Overall length 223mm (8¾"), Double-Ended

Catalog #	Description
7814M	Dissector, 8.0mm Retractor, 13.0mm



**Jost Dissector/Elevator**

Overall length 200mm (7¾"), Double-Ended

Catalog #	Description
7879	Elevator, 3.5 x 35.0mm Dissector, 5.8 x 17.0mm



### Birket Tonsil Seizing Forceps

Catalog #	Description
7823	Straight, 197mm (7¾")



### Bourgeois Tonsil Forceps

Overall length 210mm (8¼")

Catalog #	Description
7819	2 x 2 Teeth, Curved



### Chaput Tissue Forceps

Overall length 134mm (5¼")

Catalog #	Description
7866-13	5.5mm, With Teeth



### Chatelier Adenoid Forceps

Overall length 208mm (8¼")

Catalog #	Description
7826-1-7	10.5 x 31.0mm, Angled Jaw



### Marie Nerve Dissecting Forceps

Catalog #	Description
7830M	Full Curved, 200mm (7¾")



### Martin Bone Cutting Forceps

Overall length 248mm (9¾")

Catalog #	Description
7765	42.0mm Blades, Straight



### Negus Tonsil Seizing Forceps

Catalog #	Description
7825	1.8mm, Curved Tip, 166mm (6½")



### O'Shaugnessy Tonsil Seizing Forceps

Catalog #	Description
7837-18	Full Curved, 180mm (7")



### Portmann Tonsil Seizing Forceps

Catalog #	Description
7820	3 x 4 Teeth, 215mm (8½")



### Redon Dissecting Forceps

Catalog #	Description
7920	Full Curved, 138mm (5¾")



### Schmidt Tonsil Seizing Forceps

Catalog #	Description
7822	Light Curved, One Open Ring, 188mm (7½")



### April Oral Stabilizer

Low-profile mouth guard helps protect the frenulum, roof of mouth, and fragile gum mucosa from incidental trauma. Longer lateral loop helps improve handpiece maneuverability and blade access.

Developed in conjunction with Max April, MD  
Overall length 161mm (6¼")



MCL200

Catalog #	Description
MCL200	Left (for right-handed surgeon)
MCL201	Right (for left-handed surgeon)

### Chabolle Tongue Depressor

Working length 81mm (3¼")



MCR2A

Catalog #	Description
MCR2A	39.3 x 90.0mm, Blade No. 2, Fenestrated
MCR3A	40.0 x 100.0mm, Blade No. 3, Fenestrated

### Davis Boyle Mouth Gag

Overall length 155mm (6")



Catalog #	Description
7802C	Double Bite Left, Frame Only

### Davis Boyle Dental Splint Mouth Gag Insert

Catalog #	Description
7802P	13.0 x 26.0mm, 2/Pkg



### Davis Boyle Tongue Depressor

Catalog #	Description
7802S-1	No. 1, 20.0 x 30.0mm, Without Suction
7802S-2	No. 2, 24.0 x 70.0mm, With Suction
7802S-3	No. 3, 25.0 x 85.0mm, With Suction
7802S-4	No. 4, 26.0 x 96.0mm, With Suction
7802S-5	No. 5, 27.0 x 110.0mm, With Suction



### Doyen Mouth Gag

Catalog #	Description
7821A*	Large, 16.0mm, 135mm (5 <sup>3</sup> / <sub>8</sub> " )
7821B*	Small, 10.0mm, 115mm (4 <sup>1</sup> / <sub>2</sub> " )

\*Not for sale in US



### Jennings Mouth Gag

Catalog #	Description
7804-9	90.0mm Spread, 145mm (5 <sup>3</sup> / <sub>4</sub> " )
7804-11	110.0mm Spread, 160mm (6 <sup>1</sup> / <sub>4</sub> " )
7804-13	130.0mm Spread, 182mm (7 <sup>1</sup> / <sub>4</sub> " )



### Kilner Mouth Gag

Catalog #	Description
7803C	Overall Length 192mm (7 <sup>1</sup> / <sub>2</sub> " )



### Kilner Tongue Depressor

Catalog #	Description
7803S-1	No. 1, 30.0 x 70.0mm
7803S-2	No. 2, 34.0 x 80.0mm
7803S-3	No. 3, 39.0 x 85.0mm





**Accessory - Palatine Blade for 7803C**

Catalog #	Description
7803B	19.0mm Wide, 60mm (2 <sup>3</sup> / <sub>8</sub> " )



**Masson Mouth Gag with Tongue Depressor**

Overall length 141mm (5<sup>1</sup>/<sub>2</sub>" )

Catalog #	Description
7809MF*	15.0 x 33.0mm Blades

\*Not for sale in US



**Seamann Seiffert Mouth Gag**

Catalog #	Description
7805-11	108.0mm Spread, 170mm (6 <sup>3</sup> / <sub>4</sub> " )
7805-13	130.0mm Spread, 193mm (7 <sup>1</sup> / <sub>2</sub> " )

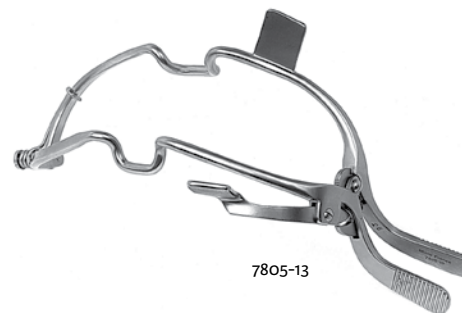



### Canuyt Tongue Depressor

Catalog #	Description
7796*	15.0 x 18.0mm, 188mm (7½")

\*Not for sale in US



### Le Mee Tongue Depressor, W/Suction

Catalog #	Description
7797-1	20.0 x 108.0mm, 153mm (6")
7797-2	23.8 x 110.0mm, 153mm (6")



7797-2

### Lecouteur Tongue Depressor

Overall length 160mm (6¼"), Double-Ended

Catalog #	Description
7800MF	23.0 and 26.5mm Ends, Angled 55°



### Portmann Tongue Depressor

Overall length 219mm (8½")

Catalog #	Description
7857	19.0mm Blade, Angled 115°



### Tongue Depressor, Disposable

Catalog #	Description
7798T*	Large Size, 10/Pkg
7798T1*	Large Size, 10/Pkg

\*Not for sale in US



7798T



7798T1

## RETRACTORS

### Blade Retractor

Catalog #	Description
7773	17.5mm Blade, 150mm (5 <sup>7</sup> / <sub>8</sub> " )



### Leroux Robert Retractor

Catalog #	Description
7923	4.9 x 56.0mm Blade, 155mm (6" )



## SCISSORS

### Guerrier Tonsil Scissors

Overall length 179mm (7" )

Catalog #	Description
7921	42.0mm Blade, Double Curve



## SNARES/SNARE WIRE

### Bruenings Tonsil Snare

Overall length 290mm (11<sup>1</sup>/<sub>2</sub>" )

Catalog #	Description
7813	Snare Working Length 119mm (4 <sup>5</sup> / <sub>8</sub> " )
7813-1	Loop, Preshaped, 4.0 x 50.0mm



7813

**Vacher Tonsil Snare**

Catalog #	Description
7810*	Snare
7810-4	Snare Guide, 1.0mm
7810-3	Snare Wire, 0.5mm, Pre-Shaped, 20/Pkg
7755-1-0-4	Snare Wire, 0.4 x 70mm Roll
7755-1-0-5	Snare Wire, 0.5 x 70mm Roll
7755-1-0-6	Snare Wire, 0.6 x 70mm Roll

\*Not for sale in US



**Krause Snare Wire, Pre-Shaped**

Catalog #	Description
7756-2	0.3mm, 20/Pkg



**Lermoyer Snare Wire, Pre-Shaped**

Catalog #	Description
7754-3	0.3mm, 20/Pkg



### Sluder Tonsillectome

Catalog #	Description
7808M	Handle
7808L-1	No. 1, 18.0mm Blade
7808L-2	No. 2, 22.0mm Blade
7808L-3	No. 3, 24.0mm Blade

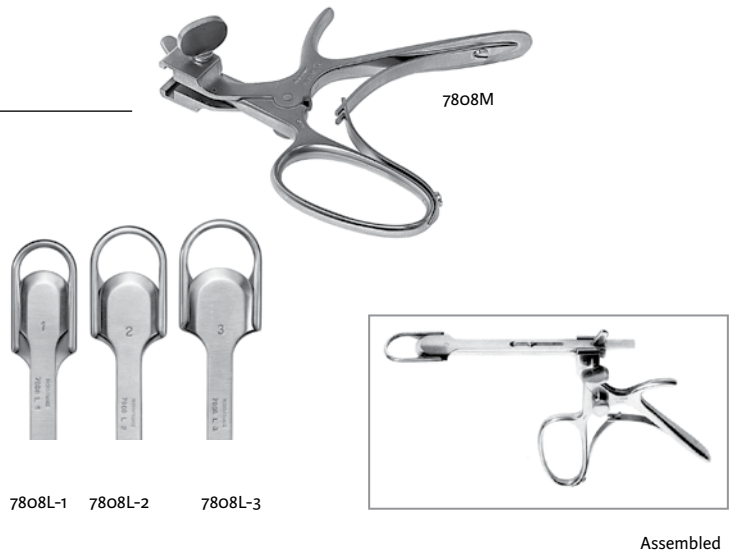

### MISCELLANEOUS

#### Camo Dental Splint-Disposable

Catalog #	Description
7960T40*	40/Pkg

\*Not for sale in US



#### Cause Air Bag

Catalog #	Description
7717C*	Overall length 455mm (18")

\*Not for sale in US

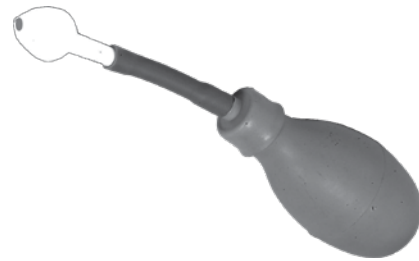

#### Guerrier Hook

Catalog #	Description
7838	Overall length 178mm (7")



### Monopolar Cautery Knife

Catalog #	Description
7706MF*	0.8 x 13.5mm, 125mm (47/8")



\*Not for sale in US

### Monopolar Knife

Working Length 110mm (4 3/8")

Catalog #	Description
7895	0.6mm Tip
CP391	Monopolar Cable, 185 cm (6'8")



### Moure Shears

Overall Length 205mm (8")

Catalog #	Description
7835	37.5mm Blades, Curved, Serrated



### Proetz Suction/Irrigator

Catalog #	Description
7881	24.0 x 115mm



### Ruault Sickle Knife

Overall Length 225mm (8 3/4")

Catalog #	Description
7811	5.0 x 21.0mm Blade, Blunt Tip



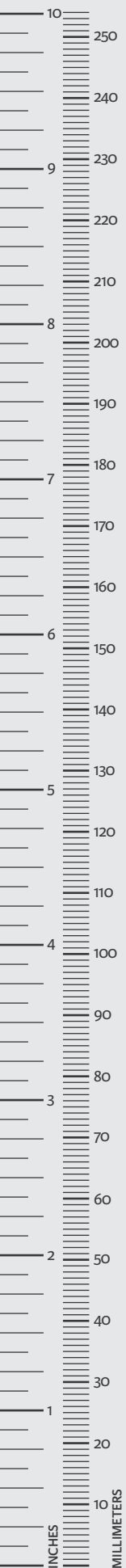

**INTEGRA**<sup>®</sup>  
LIMIT UNCERTAINTY



**Integra<sup>®</sup> MicroFrance<sup>®</sup>**

Head and Neck Instrumentation

### Henry Endoscopic Parathyroid Instrument Set

The Henry instruments were designed for the minimally invasive endoscopic lateral approach to parathyroid surgery.

The set includes a series of insulated monopolar instruments to provide hemostasis to the operative site. The 3mm trocars provide operating ports for the instrumentation and can be sutured to prevent involuntary removal. The 10mm trocar ring has been specifically designed to maintain insufflation and traction during surgery.

Developed in conjunction with Jean-François Henry, MD

Catalog #	Description
MCLP00**	Henry Endoscopic Parathyroid Instrument Set

Set consist of the following;

Catalog #	Description
MCLP10	Blunt Trocar, 3.0mm, 72mm (2 <sup>7</sup> / <sub>8</sub> " )
MCLP20	Monopolar Grasping Forceps, 2.8 x 10.0mm, 182mm (7 <sup>1</sup> / <sub>4</sub> " )
MCLP25	Monopolar Grasping Forceps, Axial, 2.8 x 10.0mm, 100mm (3 <sup>7</sup> / <sub>8</sub> " )
MCLP30	Monopolar Alligator Forceps, Axial, 1.0 x 6.0mm, 98mm (3 <sup>7</sup> / <sub>8</sub> " )
MCLP40	Monopolar Scissors, Axial, 3.0mm Blades, 92mm (3 <sup>5</sup> / <sub>8</sub> " )
MCLP50	Monopolar Coagulating Hook, 106mm (4 <sup>1</sup> / <sub>8</sub> " )
MCLP60	Blunt Probe, 180mm (7" )
MCLP70	Trocar Ring, 13.4mm Inside Diameter
CP391	Monopolar Cable, 72.8" to 6'-8"
3717012	Medium Instrument Tray, 38cm L x 25.5cm W x 7.4cm D (15" L x 10" W x 2 <sup>7</sup> / <sub>8</sub> " D)

\*\*Not for sale outside US



MCLP10



MCLP20

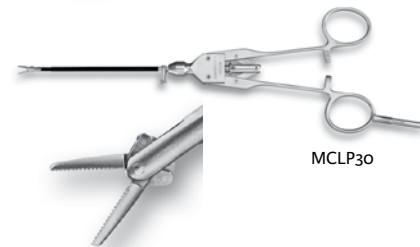

MCLP30

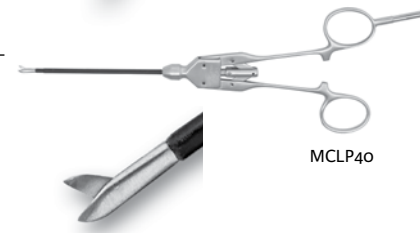

MCLP40



MCLP50



MCLP60



MCLP70

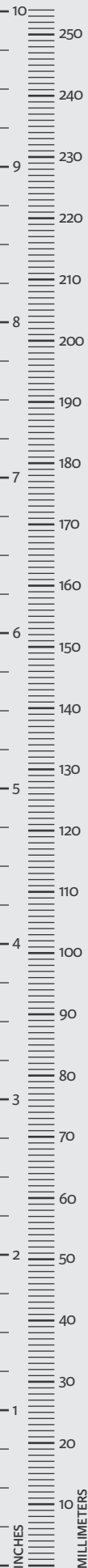
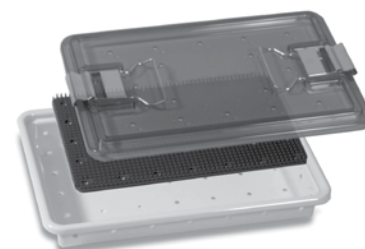



### Terris Thyroidectomy Instrument Set

The Terris Thyroidectomy instruments offer an innovative approach to address the challenges of thyroid surgery.

Developed in conjunction with David Terris, MD, FACS

Catalog #	Description
MCLT00**	Terris Thyroidectomy Instrument Set

Set consists of the following;

Catalog #	Description
MCLT10	Retractor, Small, Double-Ended, 8.0 x 15.0mm, 170mm (6¾"), 1/Pair
MCLT11	Retractor, Large, Double-Ended, 8.0 x 15.0mm, 175mm (7"), 1/Pair
MCLT20	Elevator, 2.0 x 8.0mm, 190mm (7½"), 1/Pair
MCLT21	Elevator, 4.0 x 10.0mm, 190mm (7½") 1/Pair
MCLT30	Peanut Holder, 10.0mm Jaws, 92mm (3⅝")
MCLT40	Malleable Suction Elevator, 4.5mm, 84mm (3¼")
MCLT50	Malleable Nerve Suction, 3.5mm, 141mm (5 ½")
3717012	Medium Instrument Tray, 38cm L x 25.5cm W x 7.4cm D (15" L x 10" W x 2⅞" D)

\*\*Not for sale outside US



MCLT10



MCLT11



MCLT20  
MCLT21



MCLT30



MCLT40



MCLT50



MCLT00

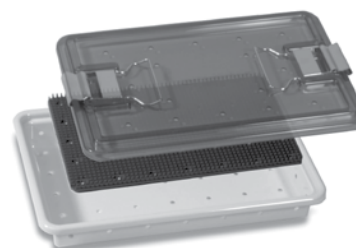

3717012

### Terris Thyroidectomy Accessories

Catalog #	Description
MCLT12R	Malleable Retractor, 3-Prong, 110mm (4 <sup>3</sup> / <sub>8</sub> "
MCLT21R	Elevator, 4.0 x 8.0mm, 330mm (13")
MCLT40R	Suction Elevator, 4.5 x 6.5mm, 135mm (5 <sup>3</sup> / <sub>8</sub> "
MCLT50R	Suction Tube, Malleable, 3.5 O.D., 330mm (13")

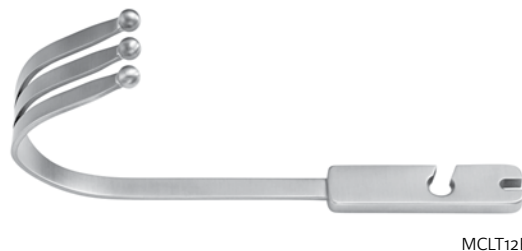

### Papon Telescope Holder

Catalog #	Description
MCLP80	Working length 54mm (2 <sup>1</sup> / <sub>8</sub> "

### Papon Endoscopic Tube Handle

Catalog #	Description
MCL112H	Overall length 98mm (3 <sup>7</sup> / <sub>8</sub> "



### Bipolar Coagulating Forceps, Insulated

Overall length 200mm (7<sup>3</sup>/<sub>4</sub>"

Catalog #	Description
CP392-10R	1.6mm Tips, Angled
CP392-5R	1.4mm Tips, Bayonet
CP392-9R	1.4mm Tips, Angled, Bayonet
CP393	Bifurcated (Banana Plug) Bipolar Cable, 4.5 M (14' - 3/4")



INTEGRA<sup>®</sup>  
LIMIT UNCERTAINTY



# Integra<sup>®</sup> MicroFrance<sup>®</sup> Laryngeal Instrumentation

### Abitbol Laser Microlaryngeal Instruments

These refined instruments help reduce many of the complications associated with laser surgery of the larynx. The set of grasping forceps is insulated and may help minimize the possibility of laser-related injuries. The forceps has integrated suction for evacuation of the laser plume, and features monopolar jaws to allow hemostasis in the areas of the larynx that are difficult to address.

Developed in conjunction with Jean Abitbol, MD

Catalog #	Description
<b>MCL205</b>	Monopolar Grasping Forceps W/ Suction, 3.0 x 8.0mm, Fenestrated Jaws, 200mm (7¾")
<b>MCL219</b>	Monopolar Heart Shaped Grasper W/ Suction, 2.0 x 3.0mm, Angled Right, 190mm (7½")
<b>MCL219-1</b>	Monopolar Heart Shaped Grasper W/ Suction, 2.0 x 3.0mm, Angled Left, 195mm (7¾")
<b>MCL241</b>	Monopolar Alligator Forceps W/Suction, Insulated, 8.0mm Tip, Curved Right, 200mm (7¾")
<b>MCL241-1</b>	Monopolar Alligator Forceps W/Suction, Insulated, 8.0mm Tip, Curved Left, 200mm (7¾")
<b>MCL210</b>	Suction Tube, Insulated, 2.5mm, 226mm (9")
<b>CP391</b>	Monopolar Cable, 185cm (72.8")

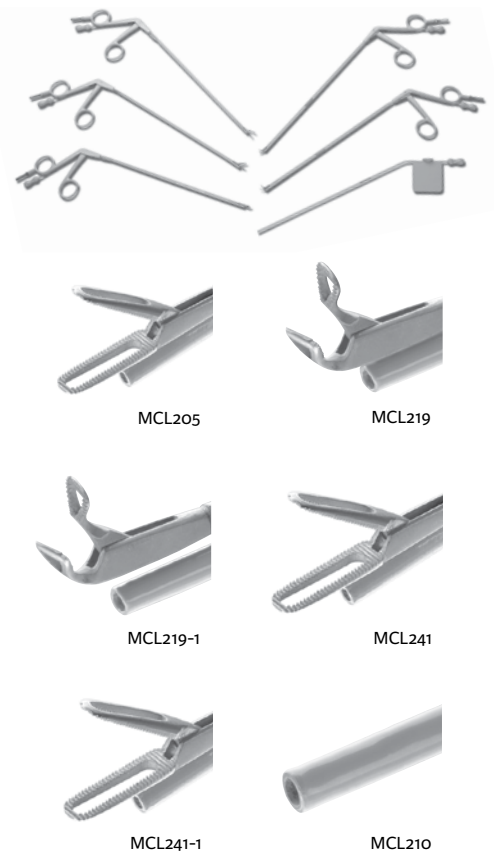

### Abitbol Accessories

Catalog #	Description
<b>3717002</b>	Instrument Tray, One-Level, 52cm L x 25cm W x 2.8cm D (20½" L x 9¾" W x 1⅛" D)

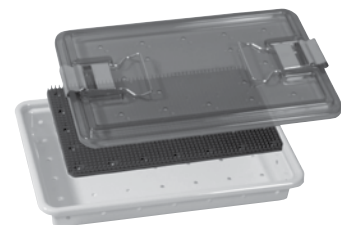

### Abitbol Laryngoscope

Working Length 81mm (3¼")

Catalog #	Description
<b>MCL290</b>	Abitbol Articulated Laryngoscope
<b>MCL294</b>	Fiberoptic Light for MCL290
<b>MCL295</b>	Suction Tube for MCL290



### Abitbol Fiberoptic Light Source

Catalog #	Description
MCL291FD	3.0mm O.D., Right, 160mm (6¼")
MCL291FG	3.0mm O.D., Left, 160mm (6¼")



### Articulated Laryngoscope

Catalog #	Description
MCL290	Overall length 210mm (8¼") Overall Tip Height 152mm (6") Proximal Opening 37.5 x 35.0mm



### Laryngoscope

Catalog #	Description
MCL291	Overall length 190mm (7½") Overall Tip Height 145mm (5¾") Proximal Opening 24.0 x 43.0mm



### Suction Tube

Catalog #	Description
MCL291AD	3.0mm O.D., Right, 140mm (5½")
MCL291AG	3.0mm O.D., Left, 140mm (5½")





### Benninger Microlaryngeal Instrument Set

These microlaryngeal instruments combine MicroFrance quality and precision with the stability of thumb-action ring handles.

Developed in conjunction with Michael Benninger, MD

Catalog #	Description
MCLB2**	Benninger Microlaryngeal Instrument Set

Set consist of the following;

Catalog #	Description
MCLB16	Micro-Scissors, 1.5mm to 8.5mm Blades, Curved Right, Working length 225mm (8¾")
MCLB17	Micro-Scissors, 1.5mm to 8.5mm Blades, Curved Left, Working length 225mm (8¾")
MCLB30	Suture Knot Pusher, Working length 171mm (6¾")
MCLB31	Micro-Scissors, 1.5mm Blades, Angled Up 70°, Working length 225mm (8¾")
MCLB94	Needle Driver, 1.6 x 5.0mm Serrated Jaws, Angled Up 70°, Working Length 218mm (8½")
MCLS18R	Cup Forceps, 2.3mm, Downbiting, Working length 249mm (9¾")
MCL-S21R	Heart-Shaped Grasper, 2.0 x 3.0mm, Right, Working length 249mm (9¾")
MCL-S22R	Heart-Shaped Grasper, 2.0 x 3.0mm, Left, Working length 249mm (9¾")
MCL-S23R	Alligator Forcecep, 7.4mm, 220mm to 225mm and 9¾" to 8⅞" Jaw, Right, Working length 249mm (9¾")
MCL-S24R	Alligator Forcecep, 7.4mm, 220mm to 225mm and 9¾" to 8⅞" Jaw, Left, Working length 249mm (9¾")



MCLB16



MCLB17



MCLB30



MCLB31



MCLB94



MCLS18R



MCL-S21R



MCL-S22R



MCL-S23R



MCL-S24R



Reverse Action Handle

\*\*Not for sale outside US

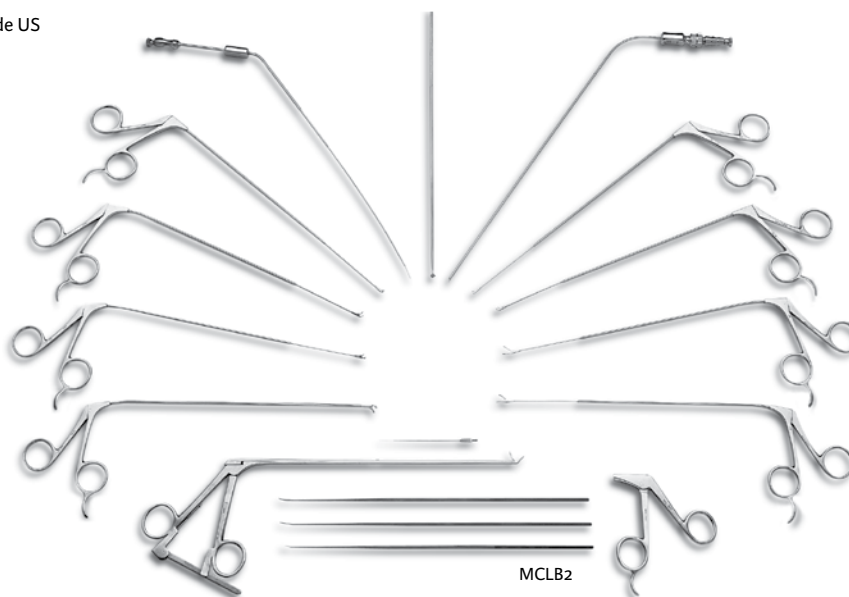

MCLB2



Benninger's Microlaryngeal Instrument Set (continued)

Satloff Microlaryngeal Instruments Included in this set;

Catalog #	Description
MCL-S0	Suction/Irrigation Adapter, 186mm (7¼")
MCL-S1	Elevator, 1.0 x 9.0mm, Curved, 252mm (10")
MCL-S7	Elevator, 1.0 x 10.0mm, Straight, 252mm (10")
MCL-S4	Disposable Injection Needle, 0.4mm, Straight, 81mm (3¼"), 6/Pkg
MCL-S25	Disposable Sickle Knife, 6.0mm, Curved Blade, 251mm (10"), 6/Pkg
MCL-S19	Universal Knife Handle
MCL-S16	French Velvet Eye Suction, 3FR., 0.9mm O.D., 238mm (9¼")
3734109	Suction Tube, 5FR. 2mm O.D., 270mm (10¾")
MCLB2SC	Benninger Instrument Tray, 54.5cm L x 28cm W x 8cm D (21½" L x 10" W x 3⅞" D)



### Bouchayer Laryngeal Instrument Set

Bouchayer Laryngeal instrument set includes a range of forceps, knives, retractors, and injection instruments to address a wide variety of pathologies of the larynx.

Developed in conjunction with Marc Bouchayer, MD

Catalog #	Description
MCLB1**	Bouchayer Laryngeal Instrument Set

Set consists of the following;

Catalog #	Description
MCL10	Aspirating/Suction Tube, 2.5mm, 229mm (9")
MCL29	Cup Forceps, 1.3mm, Curved Left, 222mm (8¾")
MCL30	Cup Forceps, 1.3mm, Curved Right, 222mm (8¾")
MCL67	Cup Forceps, Oval, 1.0 x 2.0mm, Up Angle, 222mm (8¾")
MCL68	Cup Forceps, Oval, 1.0 x 2.0mm, Left, 222mm (8¾")
MCL69	Cup Forceps, Oval, 1.0 x 2.0mm, Right, 222mm (8¾")
MCL16	Micro Scissors, 4.6mm, Right, 222mm (8¾")
MCL17	Micro Scissors, 4.6mm, Left, 222mm (8¾")
MCL31	Micro Scissors, 4.2mm, Up Angle, 220mm (8¾")
MCL15	Alligator Forceps, 9.5mm, Curved Left, 228mm (9")
MCL18	Alligator Forceps, 9.5mm, Curved Right, 228mm (9")
MCL19	Heart Shaped Forceps, Fenestrated, Serrated, Curved Left, 222mm (8¾")
MCL19BIS	Heart Shape Forceps, Fenestrated Serrated, Curved Right, 222mm (8¾")
MCL57	Lancet Knife, 2.0 x 3.0mm, 225mm (8¾")
MCL55	Pistol Injector, 0.56 cc per Click, Overall Length 157mm (6.2") Includes MCL55-1 (19 gauge needle), Connector, Wrench
MCL58	Injection Needle, Bayonet, 0.5mm (25GA), 215mm (8½")

\*\*Not for sale outside US

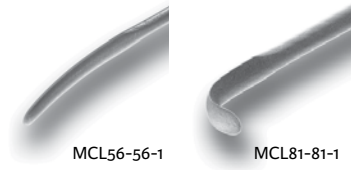



Bouchayer Laryngeal Instrument Set (continued)

Catalog #	Description
MCL59	Freche Monopolar Knife, Bayonet Tip, Working length 227mm (9")
MCL82	Bouchayer Vocal Cord Retractor, 5.0 x 19.0mm Tips, Working length 227mm (9")
MCL93	Bouchayer Knife Handle, W/3 Replacement Blades, 2.0 x 3.0mm Lancet, Working length 210mm (8¼")
MCL94	Bouchayer Needle Holder, 1.5 x 9.5mm Serrated, Working length 222mm (8¾")
CP391	Monopolar Cable, 1.8m (5'-9")
MCL190	Bouchayer Instrument Tray, 54.5cm L x 25.5cm W x 6.5cm D (21½" L x 10" W x 2½" D) Includes MCL191



Bouchayer Laryngeal Instrument Accessories

Catalog #	Description
MCL55-1	Replacement Needle for MCL55, 5.0mm from Tip to Ball, 1.0mm Diameter (19 Gauge), Working Length 220mm (8¾")
MCL55-2	Right Bayonet Injection Needle for MCL55, 1.0mm Diameter (19 Gauge), Working Length 210mm (8¼")
MCL55-3	Left Bayonet Injection Needle for MCL55, 1.0mm Diameter (19 Gauge), Working Length 210mm (8¼")
MCL93-2	Replacement Knife Blades for MCL93 (3/PKG) (Not Shown)
MCL55B	Pistol Injector, 10.0mm O.D., 140mm Pistol Opening
MCL56BL	Microsurgery Elevator, 1.35 x 8.0mm, Left, 223mm (8¾")
MCL56BR	Microsurgery Elevator, 1.35 x 8.0mm, Right, 223mm (8¾")
MCL81BL	Microsurgery Elevator, 1.5 x 4.0mm, Left 95°, 220mm (8½")
MCL81BR	Microsurgery Elevator, 1.5 x 4.0mm, Right 90°, 220mm (8½")
MCL191	Bouchayer Instrument Tray 52.5cm L x 25cm W x 5.5cm D (20¾" L x 9¾" W x 2⅛" L)

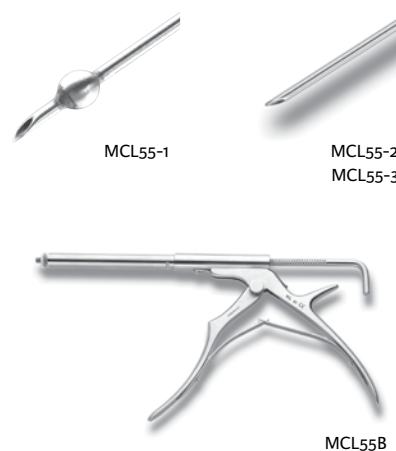

## Bouchayer Laryngoscope Set, Large

Catalog #	Description
MCL700**	Bouchayer Laryngoscope Set, Large

Set consists of the following;

Catalog #	Description
MCL77	Bouchayer Laryngoscope, Large Overall Length "A" = 18cm (7") Overall Tip Height (Retraction) "B" = 25.0mm Proximal Opening "C" = 42.0 x 28.0mm
MCL78	Fiberoptic Light

\*\*Not for sale outside US

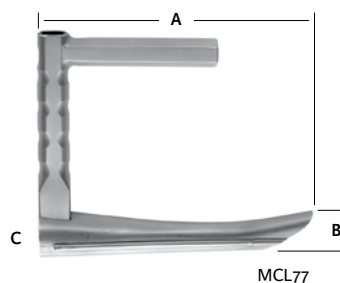

## Bouchayer Laryngoscope Set, Medium

Catalog #	Description
MCL710**	Bouchayer Laryngoscope Set, Medium

Set consists of the following;

Catalog #	Description
MCL79	Bouchayer Laryngoscope, Medium Overall Length "A" = 18cm (7") Overall Tip Height (Retraction) "B" = 22.0mm Proximal Opening "C" = 39.0 x 25.0mm
MCL78	Fiberoptic Light

\*\*Not for sale outside US

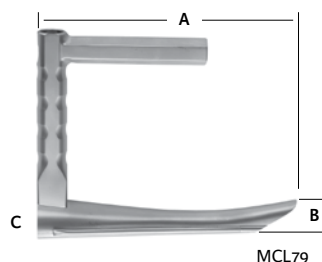

## Bouchayer Laryngoscope Accessories

Catalog #	Description
MCL76	Laryngoscope Suspension Apparatus Overall Length 35cm (13¾")
MCL35	Chest Plate for Suspension Apparatus 60.0mm x 140.0mm
7803SAT-3	Tongue Depressor for Suspension Apparatus 38.0mm Wide x 77.0mm Long
MCL78	Fiberoptic Light



### Sataloff Microlaryngeal Instrument Set

Laryngeal microsurgery requires sharp, precise, small instruments. The Sataloff Microlaryngeal Instrument Set enables the surgeon to perform these delicate procedures

Developed in conjunction with Robert T. Sataloff, MD, DMA, FACS

Catalog #	Description
MCLS40**	Sataloff Microlaryngeal Instrument Set Includes 2 Universal Handles

Set consists of the following;

Catalog #	Description
MCL-S0	Connector For Injection Needle, 185mm (7¼")
MCL-S1	Spatula, 1.6 x 10.0mm, Curved, 252mm (10")
MCL-S2	Hook, 1.0mm, 2-Prong, 251mm (10")
MCL-S3	Cotton Applicator, Twisted End, 252mm (10")
MCL-S4	Disposable Collagen Injection Needle, 0.4mm, Straight, 27GA, Working length 67mm (2⅝"), 6/Pkg
MCL-S5	Disposable Collagen Injection Needle, 0.4mm, Right Angle, 27GA, Working length 67mm (2⅝"), 6/Pkg
MCL-S7	Spatula, 1.0 x 10.0mm, Straight, 252mm (10")
MCL-S8	Spatula, 8.0mm, Angle, 252mm (10")
MCL-S9	Hook, 2.0mm Sharp, Right Angle, 252mm (10")
MCL-S10	Ball Dissector, Straight, 254mm (10")
MCL-S11	Ball Dissector, Blunt Oblique, 3.0mm, 252mm (10")
MCL-S12	Ball Dissector, Right Angle, 3.5mm, 255mm (10")
MCL-S13	Ball Dissector, Right Angle, 4.2mm, 252mm (10")
MCL-S14	Mirror, Small, 3.4mm, 253mm (10")
MCL-S15	Mirror, Large, 5.0mm, 253mm (10")
MCL-S16	French Velvet Eye Suction, 3 FR., 0.9mm O.D., Working length 238mm (9¼")
MCL-S17	French Velvet Eye Suction With Retractor Plate Below, Working length 239mm (9")
MCL-S17-1	French Velvet Eye Suction With Retractor Plate Above, Working length 239mm (9")
MCL-S18	Cup Forceps, 2.0mm Downbite, Working length 217mm (8¾")
MCL-S19	Universal Ring Handle

\*\*Not for sale outside US

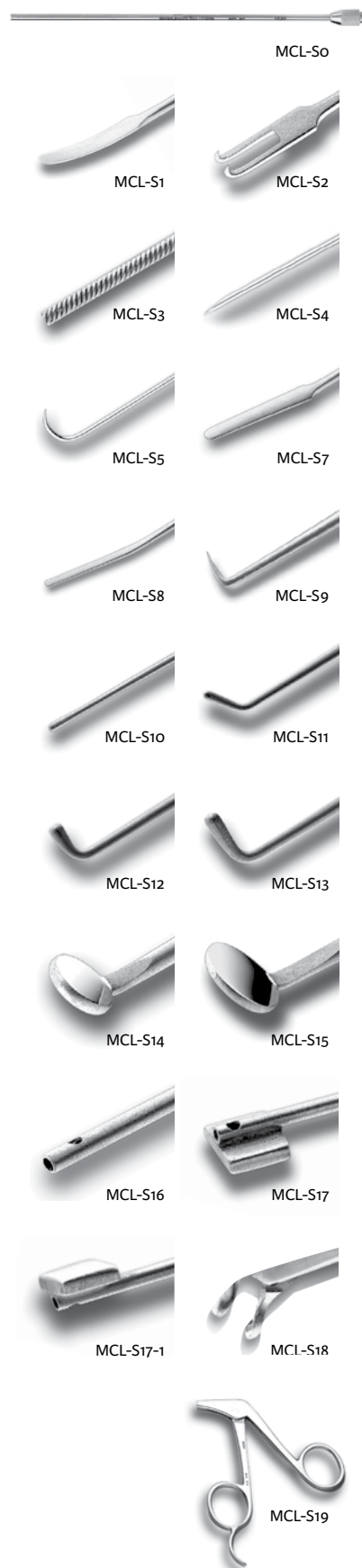

Sataloff Microlaryngeal Instrument Set (continued)

Catalog #	Description
MCL-S21	Grasper, Heart Shaped, 1.5mm Cup, Right, Working length 215mm (8½")
MCL-S22	Grasper, Heart Shaped, 1.5mm Cup, Left, Working length 215mm (8½")
MCL-S23	Alligator Forceps, 8mm, Right, Working length 220mm (8¾")
MCL-S24	Alligator Forceps, 8mm, Left, Working length 220mm (8¾")
MCL-S27	Adapter, Angled, 42mm (1⅝")
MCL-S30	Knife Handle (Sataloff) 2/EA
MCL-S31	Vascular Knife, Disposable, 94mm (3¾"), 6/Pkg, Use with MCL-S30
MCL-S32	Sharp Knife, 7.0mm, Disposable, 94mm (3¾"), 6/Pkg, Use with MCL-S30
MCL-S33	Sickle Knife, 5.0mm, Disposable, 94mm (3¾"), 6/Pkg, Use with MCL-S30
MCL-S34	Flap Knife, Disposable, 94mm (3¾"), 6/Pkg, Use with MCL-S30
MCL-S35	Percutaneous Injection Needle, 18GA
MCL-S38	Curette, Overall length 254mm (10")
MCL-S39	Alligator Forceps, Fine, Angled Right, 220mm (8⅞")
MCL-S41	Alligator Forceps, Fine, Angled Left, 220mm (8⅞")

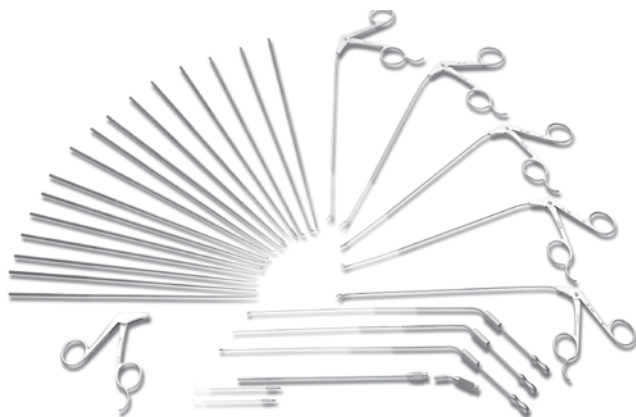
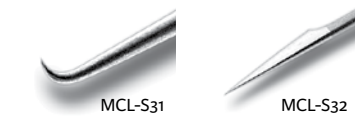

MCLS40



Sataloff Microlaryngeal Instrument Accessories

Catalog #	Description
MCL-S6	Sharp Knife, 7.0mm, 252mm (10"), Disposable, 6/Pkg, Use With MCL-S19
MCL-S20	Vascular Knife, 250mm (9¾"), Use With MCL-S19
MCL-S25	Sickle Knife, 7.0mm, 251mm (10"), Disposable, 6/Pkg, Use With MCL-S19
MCL-S26	Sharp Knife, 2.3mm, Angled Right
MCL-S36	Instrument Tray for Laryngeal Forceps, 1 Level, 49.5cm L x 22.5cm W (19½" L x 8¾" W)
MCL-S37	Instrument Tray for Sataloff Picks, Handles and Injection System, 1 Level, 19.5cm W x 8.9cm L, Holds 16 Picks, 2 Handles, 12 Needles (7¾" L x 3½" W)
MCL-S42	Disposable Injection Needle, Curved, 22GA, 6/Pkg
MCL-S43	Disposable Injection Needle, Straight, 22GA, 6/Pkg



### Sataloff Laryngoscopes

The Sataloff Laryngoscopes have a large proximal opening for binocular microscope vision. They offer dual light fibers and dual suction for maximum illumination and visualization during microsurgery. The elevated triangular tips have been blunted that may help reduce tissue trauma.

The anterior commissure laryngoscopes (MCL120, MCL121, MCL122, and MCL123) have been designed to help provide the ability to examine the vocal cords at the anterior commissure. In addition, the MCL125 anterior commissure laryngoscope was designed for patients with limited laryngeal exposure.

The Vallecula Laryngoscope (MCL124) has a wide proximal opening and a high blunted lift on the distal tip.

All laryngoscopes can be used with the MicroFrance suspension apparatus (MCL76) and chest plate (MCL35).

Catalog #	Description
MCL120	Laryngoscope with Dual Suction and Light Fibers, Small
MCL121	Laryngoscope with Dual Suction and Light Fibers, Medium
MCL122	Laryngoscope with Dual Suction and Light Fibers, Large
MCL123	Laryngoscope with Dual Suction and Light Fibers, Small-Medium
MCL124	Vallecula Laryngoscope with Dual Suction and Light Fibers
MCL125	Anterior Commissure Laryngoscope with Dual Suction and Light Fibers 1, For patients with limited anterior exposure

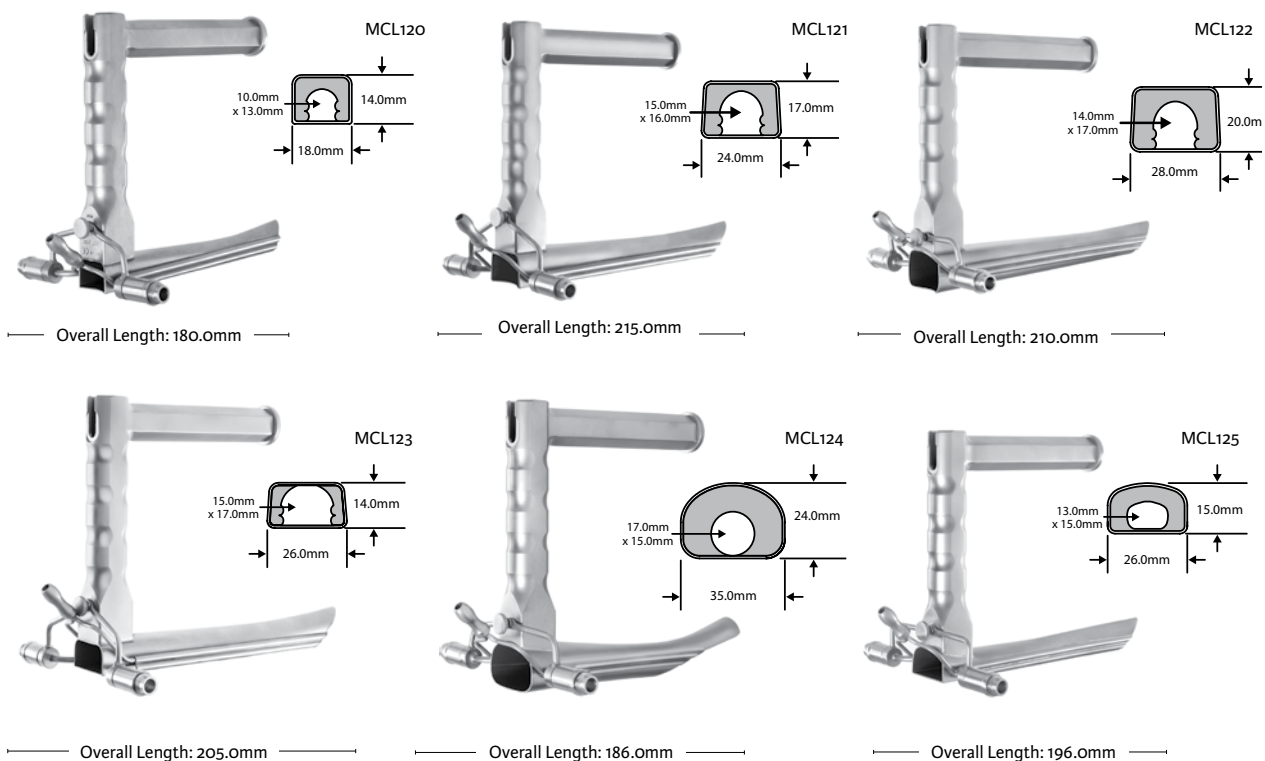

Sataloff Laryngoscope Accessories

Catalog #	Description
MCL35	Chest Plate for Suspension Apparatus
MCL76	Laryngoscope Suspension Apparatus
MCLS120-1	Left Light Fiber Replacement, Small
MCLS120-2	Right Light Fiber Replacement, Small
MCLS120-3	Suction Assembly Replacement, Small
MCLS121-1	Left Light Fiber Replacement, Medium
MCLS121-2	Right Light Fiber Replacement, Medium
MCLS121-3	Suction Assembly Replacement, Medium
MCLS122-1	Left Light Fiber Replacement, Large
MCLS122-2	Right Light Fiber Replacement, Large
MCLS122-3	Suction Assembly Replacement, Large
MCLS123-1	Left Light Fiber Replacement, Small-Medium
MCLS123-2	Right Light Fiber Replacement, Small-Medium
MCLS1233	Suction Assembly Replacement, Small-Medium
MCL124FL	Left Light Fiber Replacement, Vallecula
MCL124FR	Right Light Fiber Replacement, Vallecula
MCL124ST	Suction Assembly Replacement, Vallecula
MCL125FL	Left Light Fiber Replacement, Anterior Commissure
MCL125FR	Right Light Fiber Replacement, Anterior Commissure
MCL125ST	Suction Assembly Replacement, Anterior Commissure
3717023	Laryngoscope Instrument Tray 52 .5cm L x 25.0cm W x 17.0cm D (20 <sup>3</sup> / <sub>4</sub> " L x 9 <sup>3</sup> / <sub>4</sub> " W x 6 <sup>3</sup> / <sub>4</sub> " D) Holds Two Laryngoscopes, Two Fiberoptic Cables, Suspension Apparatus, and Chest Plate





### Sataloff Indirect Laryngeal Instrument Set

The Sataloff Indirect Laryngeal Instrument Set is used for office-based procedures. This set includes dilators, cupped forceps, scissors, heart-shaped forceps, alligator forceps, and suctions that are curved to help facilitate access to the laryngeal region with the patient in a sitting position. The smaller instrument tray has been designed for use with office-oriented sterilization equipment.

Developed in conjunction with Robert T. Sataloff, MD, DMA, FACS

Catalog #	Description
MCLS62**	Sataloff Indirect Laryngeal Instrument Set

Set consists of the following;

Catalog #	Description
1650030	Oro-Tracheal Injector with Curved Cannula, 222mm (8¾")
MCLS44	Sataloff Laryngeal Dilator, Size 0, 9.5mm, 205mm (8")
MCLS45	Sataloff Laryngeal Dilator, Size 1, 11.3mm, 205mm (8")
MCLS46	Sataloff Laryngeal Dilator, Size 2, 14.1mm, 205mm (8")
MCLS47	Sataloff Laryngeal Dilator, Size 3, 16.3mm, 205mm (8")
MCLS48	Modular Handle, 200mm (7¾")
MCLS49	Indirect Cup Forceps, 2.4mm, Straight, 175mm (7")
MCLS50	Indirect Cup Forceps, 2.4mm, Left, 175mm (7")
MCLS51	Indirect Cup Forceps, 2.3mm, Curved Right, 185mm (7¼")
MCLS52	Indirect Scissors, 3.0mm, Straight, 180mm (7")
MCLS53	Indirect Scissors, 3.0mm, Right, 180mm (7")
MCLS54	Indirect Scissors, 3.0mm, Curved Left, 175mm (7")
MCLS55	Indirect Heart Shaped Forceps, 4.0mm, Curved Left, 180mm (7")
MCLS56	Indirect Heart Shaped Forceps, 4.0mm, Curved Right, 180mm (7")
MCLS57	Indirect Alligator Forceps, 5.0mm, Straight, 180mm (7")
MCLS58	Indirect Alligator Forceps, 5.0mm, Curved Right, 180mm (7")
MCLS59	Indirect Alligator Forceps, 5.0mm, Curved Left, 180mm (7")
MCLS60	Indirect Suction Tube, 5FR., 192mm (7½")
MCLS61	Indirect Suction Tube, 7FR., 192mm (7½")
MCLS63	Vascular Knife, 2.0mm Tip, 58mm (2¼")
MCLS64	Sharp Knife, 7.0mm Tip, 60mm (2¾")
MCLS65	Sickle Knife, 6.0mm Tip, 58mm (2¼")
MCLS66	Flap Knife, 3.0mm Tip, 58mm (2¼")
MCLS62SC	Instrument Tray 38cm L x 23.6cm W x 11cm D (15" L x 9¼" W x 4¾" D)"

\*\*Not for sale outside US



MCLS62





## DILATORS

### Laborde Tracheal Dilator

Catalog #	Description
7840	Overall length 120.0mm (4¾")



## DIVERTICULOSCOPIES

### Lacau Diverticuloscope

Catalog #	Description
MCL49	Overall length 280mm (11") Distal Opening 20.0 x 16.0mm Proximal Opening 36.0 x 29.0mm
MCL49F	Fiberoptic Light for MCL49

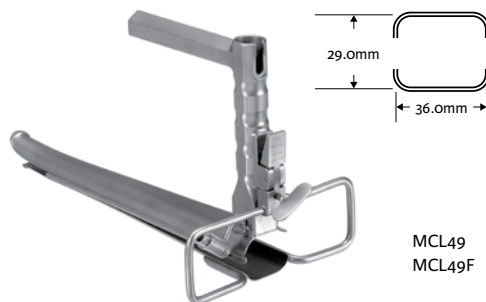

MCL49  
MCL49F

### Reyt Diverticuloscope

Catalog #	Description
MCL88	Overall length 250mm (9⅞") Distal Opening 20.0 x 16.0mm Proximal Opening 37.0 x 23.0mm
MCL88-1	Suction Tube for MCL88
MCL88-2	Fiberoptic Light for MCL88

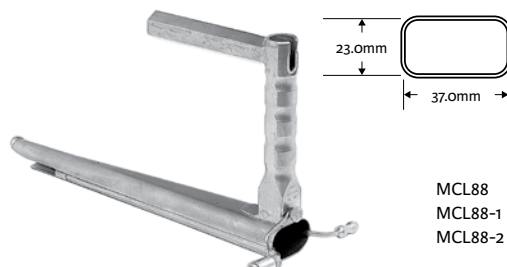

MCL88  
MCL88-1  
MCL88-2

## Esophoscopes and Suctions

Catalog #	Description
MCL112H	Papon Endoscopic Tube Handle
MCL320	Endoscope Tube, 12.0 x 16.0mm O.D., 300mm (11¾")
MCL320F	Fiberoptic Light Source for MCL320
MCL330	Endoscope Tube, 12.0 x 16.0mm O.D., 500mm (19¾")
MCL330F	Fiberoptic Light Source for MCL330
MCL920L35	2.0mm, Suction Tube, Blunt, 350mm (13¾")
MCL925L35	2.5mm, Suction Tube, Blunt, 350mm (13¾")
MCL930L35	3.0mm, Suction Tube, Blunt, 350mm (13¾")
MCL935L35	3.5mm, Suction Tube, Blunt, 350mm (13¾")
MCL940L35	4.0mm, Suction Tube, Blunt, 350mm (13¾")



MCL112H



MCL320, MCL320F, MCL112H

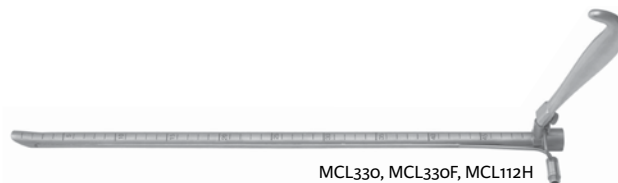

MCL330, MCL330F, MCL112H



MCL920L35

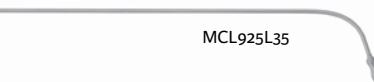

MCL925L35

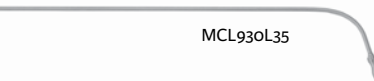

MCL930L35



MCL935L35

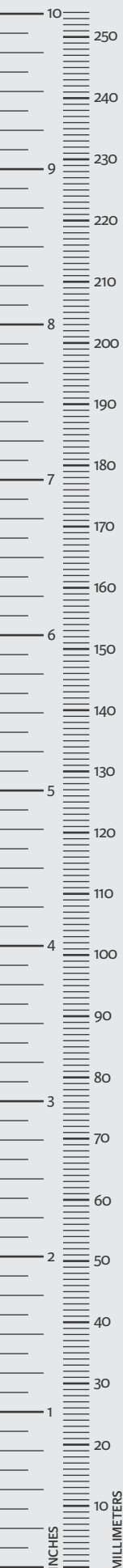

**ELEVATORS**

**Bouchayer Micro Elevator**

Working length 220mm (8½")

Catalog #	Description
MCL56BL	1.35 x 8.0mm, Curved Left
MCL56BR	1.35 x 8.0mm, Curved Right
MCL81BL	1.5 x 4.0mm, Angled Left 90°
MCL81BR	1.5 x 4.0mm, Angled Right 90°

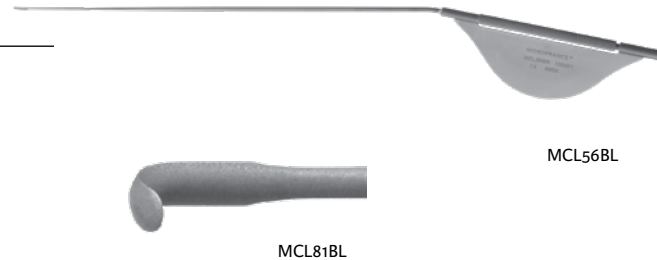

**Perouse Micro Elevator**

Working length 220mm (8½")

Catalog #	Description
MCL56PL	0.65 x 4.0mm, Curved Left
MCL56PR	0.65 x 4.0mm, Curved Right
MCL81PL	0.8 x 2.0mm, Angled Left 90°
MCL81PR	0.8 x 2.0mm, Angled Right 90°

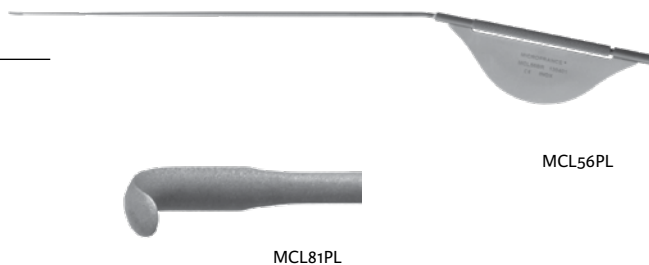

**LARYNGEAL FORCEPS**

**Laryngeal Biopsy Forceps**

Working length 178mm (7")

Catalog #	Description
7843A-1	4.0mm, Straight, Shaft Curved Down



**Laryngeal Alligator Forceps, W/Cleaning Port**

Working length 228mm (9")

Catalog #	Description
MCL25	9.8mm Jaw, Straight



### Laryngeal Biopsy Cup Forceps

Catalog #	Description
7844T74L20	3.4mm, 200mm (7¾")
7844T74L25	3.4mm, 250mm (9¾")
7844T74L30	3.4mm, 300mm (11¾")
7844T74L35	3.4mm, 350mm (13¾")
7844T74L40	3.4mm, 400mm (15¾")
7844T74L45	3.4mm, 450mm (17¾")
7844T74L50	3.4mm, 500mm (19¾")
7844T74L55	3.4mm, 550mm (21¾")
7844T74L60	3.4mm, 600mm (23¾")

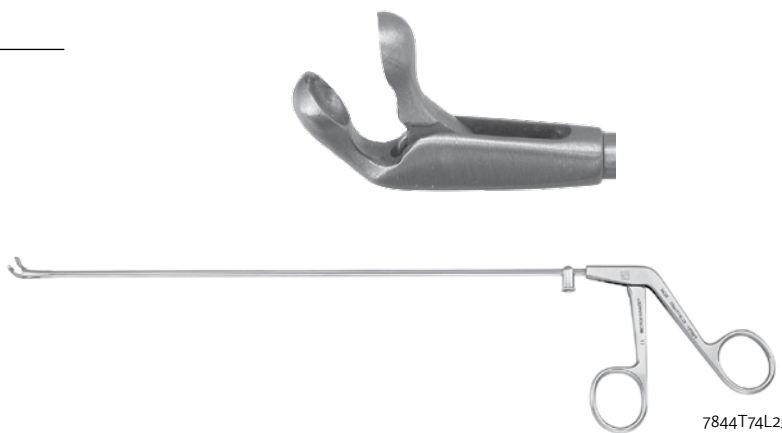

7844T74L25

### Laryngeal Biopsy Cup Forceps

Catalog #	Description
7844T5L20	3.6mm, 200mm (7¾")
7844T5L25	3.6mm, 250mm (9¾")
7844T5L30	3.6mm, 300mm (11¾")
7844T5L35	3.6mm, 350mm (13¾")
7844T5L40	3.6mm, 400mm (15¾")
7844T5L45	3.6mm, 450mm (17¾")
7844T5L50	3.6mm, 500mm (19¾")
7844T5L55	3.6mm, 550mm (21¾")
7844T5L60	3.6mm, 600mm (23¾")

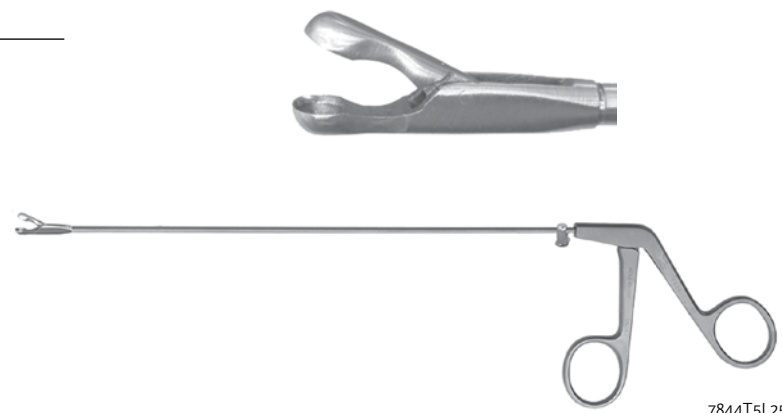

7844T5L25

### Laryngeal Biopsy Cup Forceps, W/Cleaning Port

Catalog #	Description
MCL12	2.5mm Cup, Straight, 224mm (8¾")
MCL13	2.5mm Cup, Curved Right, 214mm (8½")
MCL14	2.5mm Cup, Curved Left, 214mm (8½")
MCL33	2.5mm Cup, Curved Up, 220mm (8¾")

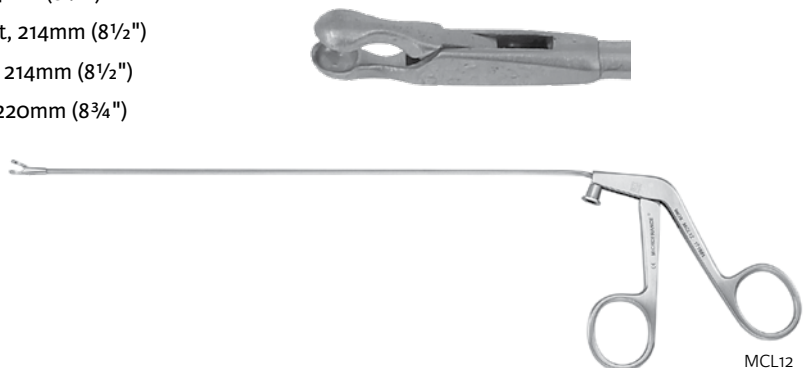

MCL12

### Laryngeal Biopsy Oblong Cup Forceps

Catalog #	Description
7844T6L20	3.5 x 12.0mm, 215mm (8½")
7844T6L25	3.5 x 12.0mm, 250mm (9¾")
7844T6L30	3.5 x 12.0mm, 300mm (11¾")
7844T6L35	3.5 x 12.0mm, 350mm (13¾")
7844T6L40	3.5 x 12.0mm, 400mm (15¾")
7844T6L45	3.5 x 12.0mm, 450mm (17¾")
7844T6L50	3.5 x 12.0mm, 500mm (19¾")
7844T6L55	3.5 x 12.0mm, 550mm (21¾")
7844T6L60	3.5 x 12.0mm, 600mm (23¾")

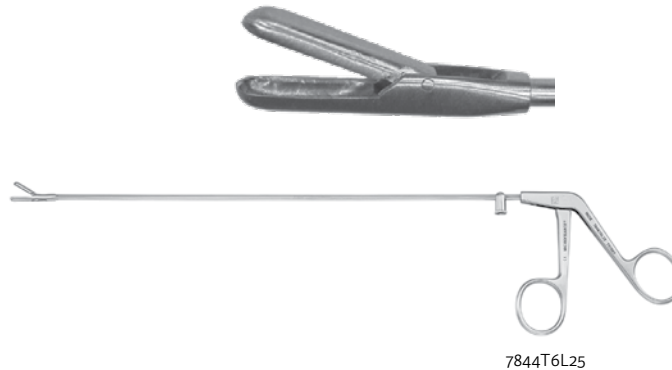

### Laryngeal Crocodile Forceps

Catalog #	Description
7844T3L20	3.6 x 12.5mm, 215mm (8½")
7844T3L25	3.6 x 12.5mm, 250mm (9¾")
7844T3L30	3.6 x 12.5mm, 300mm (11¾")
7844T3L35	3.6 x 12.5mm, 350mm (13¾")
7844T3L40	3.6 x 12.5mm, 400mm (15¾")
7844T3L45	3.6 x 12.5mm, 450mm (17¾")
7844T3L50	3.6 x 12.5mm, 500mm (19¾")
7844T3L55	3.6 x 12.5mm, 550mm (21¾")
7844T3L60	3.6 x 12.5mm, 600mm (23¾")

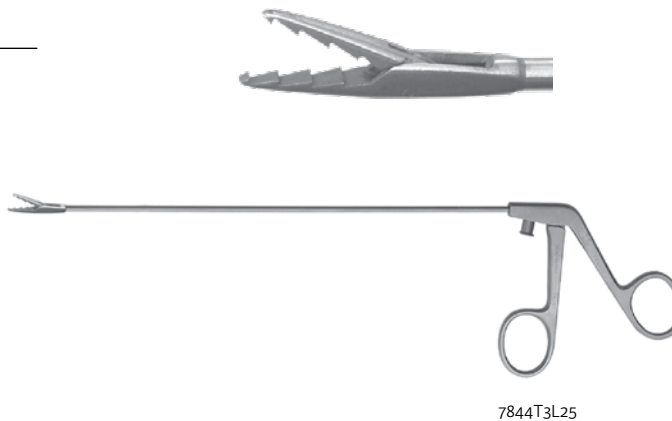

### Laryngeal Bipolar Forceps

The Laryngeal Bipolar Forceps are designed for laryngology and phonosurgery procedures.

The coagulating tip is 5mm in length, and the design helps ensure that the bipolar energy is delivered in a controlled manner. The 29cm length and the 3mm outer diameter make these forceps useful for delicate work. A specially designed stainless steel instrument tray is also included.

Catalog #	Description
MCL34	290mm (11½"), in Case
CP393	Bifurcated (Banana Plug) Bipolar Cable, 4.5m (14'-¾")

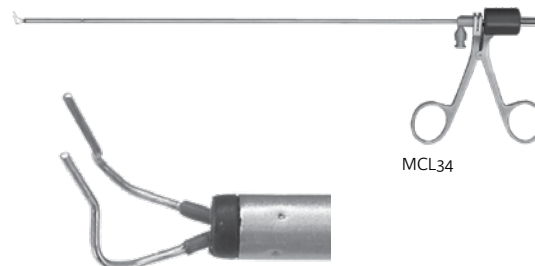

**Laryngeal Micro Bipolar Forceps, W/Cleaning Port**  
Working length 210mm (8¼")

Catalog #	Description
MCL340	2.0 x 7.0mm, Angled, 3.5mm O.D.



**Laryngeal Forceps, W/Cleaning Port**

Catalog #	Description
7843-1	11.5mm Jaws, 215mm (8½")



**Laryngeal Hook**

Overall length 333mm (13")

Catalog #	Description
MCL7	0.85 x 3.3mm Jaws, Angled 90°

**Laryngeal Modular Handle**

Overall length 142mm (5⅝")

Catalog #	Description
MCL828	15.0 x 40.0mm
MCL828C	Laryngeal Handle Rack



MCL828C

### Dauphin Hypopharyngoscope

Catalog #	Description
MCL110	Overall length 198.0mm (7¾") Distal Tip 15.0 x 18.0mm Proximal Tip 9.5 x 13.7mm
MCL111	Fiberoptic Light Source for MCL110



### Hypopharyngoscope

Catalog #	Description
MCL112	Overall length 230mm (9") Distal Tip 12.6 x 11.0mm Proximal Tip 13.6 x 10.0mm
MCL112F	Fiberoptic Light Source for MCL112
MCL112H	Papon Endoscopic Tube Handle



## Casiano Transcervical Laryngeal Injection Medialization Needle

The Casiano Needle was designed specifically for the transcervical approach to vocal fold medialization.

Developed in conjunction with Roy R. Casiano, MD

Catalog #	Description
MCL55T**	Casiano Needle Set

Set consist of the following;

Catalog #	Description
MCL55T4	Casiano Needle Handle
MCL55T5	Casiano Transcervical Laryngeal Injection Needle, 21 Gauge, 6/Pkg
MCL55T6	Casiano Needle Trocar Obturator, Sharp, 6/Pkg
MCSKoSC	Instrument Tray, One-Level 19.8cm L x 11.0cm W x 2.2cm D (7 <sup>3</sup> / <sub>4</sub> " L x 4 <sup>3</sup> / <sub>8</sub> " W x 7/ <sub>8</sub> " D)

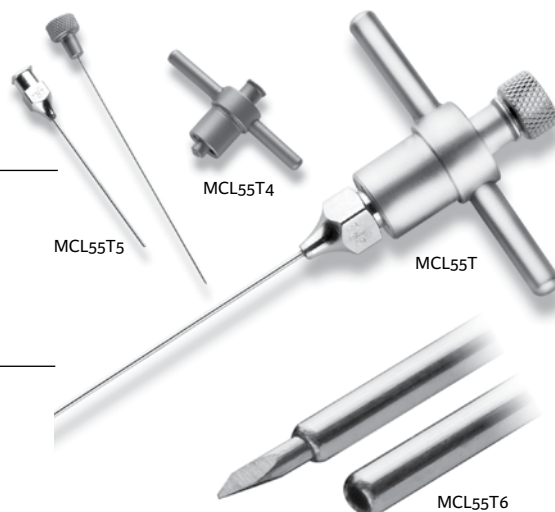

\*\*Not for sale outside US

## Injection Needle, Malleable

Overall length 250mm (9<sup>3</sup>/<sub>4</sub>" )

Catalog #	Description
MCL55U	24 Gauge, 6/Pkg



## Luer-Lock Adapter

Catalog #	Description
MCL55R	For MCL55U Needle





### Laryngeal Sickle Knife

Working length 225mm (8¾")

Catalog #	Description
MCL1BIS	11.0mm Blade



### Laryngeal Sickle Knife Holder

Overall length 253mm (10")

Catalog #	Description
MCL92-1	Angled



### Microsurgery Knife

Overall length 233mm (9¼")

Catalog #	Description
MCL4	3.0 x 3.4mm, Angled
MCL5	2.5 x 4.0mm, Angled

### Dédo-Frèche Laryngoscope

Catalog #	Description
MCL46	Overall length 197mm (7¾") Distal Opening, 16.0 x 19.0mm Proximal Opening, 20.0 x 30.0mm
MCL46A	Suction Tube, 3.0mm O.D., 180mm (7"), for MCL46
MCL47	Fiberoptic Light Source, 3.0mm O.D., for MCL46

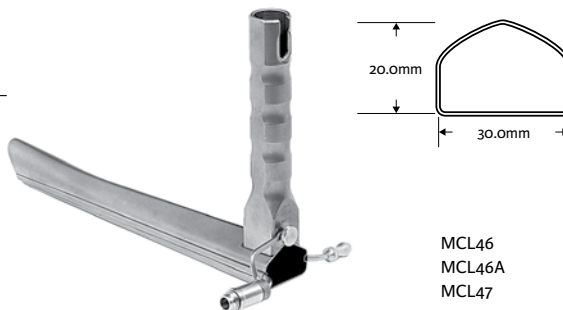

### Garcin Laryngoscope, Small

Catalog #	Description
MCL37	Overall length 100mm (3⅞") Proximal Opening, 13.5 x 23.5mm
MCL42	Fiberoptic Light Source 3.0mm O.D, for MCL37

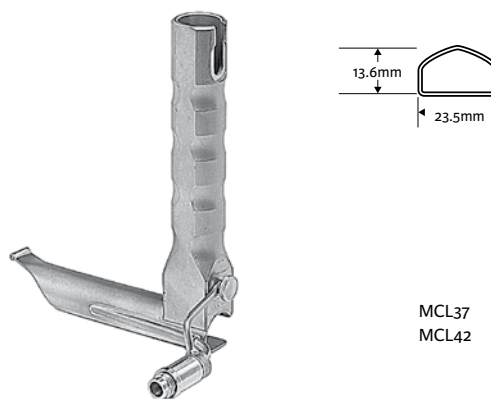

### Laryngoscope, Extra Small

Catalog #	Description
MCL37D	Overall length 75mm (3") Proximal Opening 19.0 x 8.0mm
MCL37DF	Fiberoptic Light Source 3.0mm O.D, for MCL37D

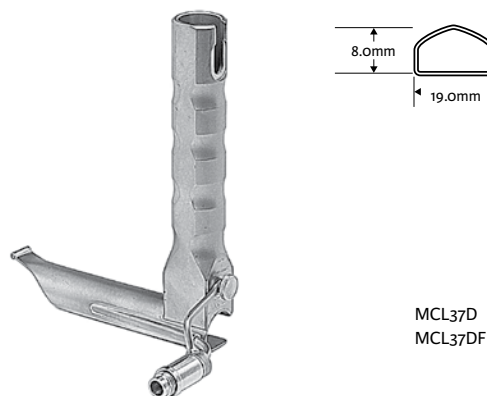

### Laryngoscope, Small

Catalog #	Description
MCL37C	Overall length 73mm (2⅞") Proximal Opening 23.0 x 13.5mm
MCL37CF	Fiberoptic Light Source 3.0mm O.D, for MCL37C

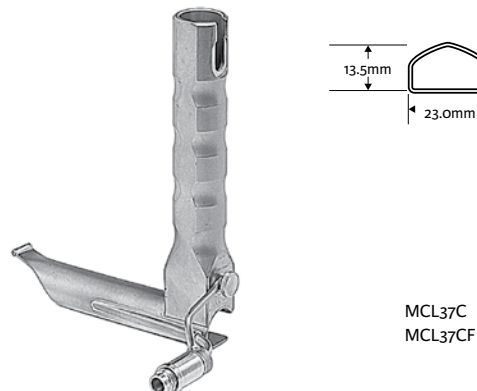

### Garabedian Laryngoscope

Catalog #	Description
MCL37G	Overall length 100mm (3 <sup>7</sup> / <sub>8</sub> " Proximal Opening 23.0 x 14.0mm
MCL38N	Fiberoptic Light Source, 3.0mm O.D., for MCL37G

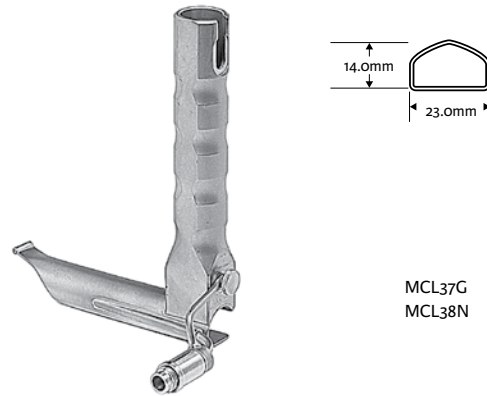

### Brasnu Laryngoscope

Catalog #	Description
MCL89	Overall length 195mm (7 <sup>3</sup> / <sub>4</sub> " Distal Opening 18.0 x 18.0mm Proximal Opening 42.0 x 27.0mm
MCL89-1	Laryngeal Suction, 3.0mm O.D. for MCL89
MCL89-2	Fiberoptic Light Source, 3.0mm O.D. for MCL89

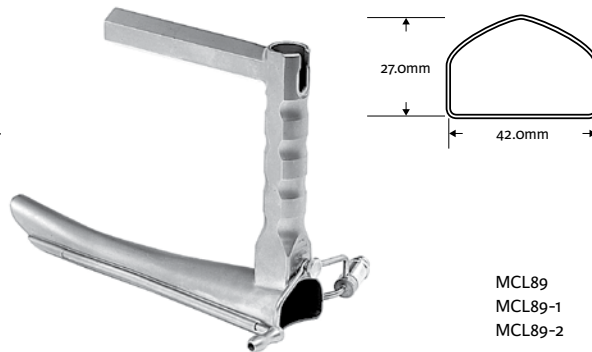

### Laryngoscope, 2 Channels

Catalog #	Description
MCL83	Overall Length 180mm (7") Distal Opening, 18.0 x 17.0mm Proximal Opening, 39.0 x 26.0mm
MCL83-1	Suction Tube, 3.0mm O.D., for MCL83, 150.0mm (5 <sup>7</sup> / <sub>8</sub> "
MCL84	Fiberoptic Light Source, 3.0mm O.D., for MCL83

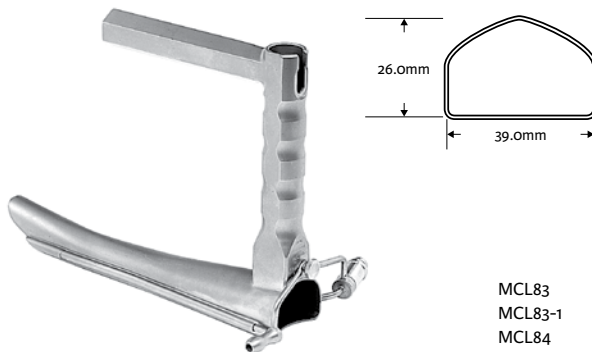

### Laryngoscope

Catalog #	Description
MCL65A	Overall length 182mm (7 <sup>1</sup> / <sub>4</sub> " Distal Opening 21.0 x 25.0mm Proximal Opening 42.5 x 17.0mm
MCL65AF	Fiberoptic Light Source, 3.0mm O.D., for MCL65A
MCL65AS	Suction Tube, 3.0mm O.D., for MCL65A, 105mm (4 <sup>1</sup> / <sub>8</sub> "

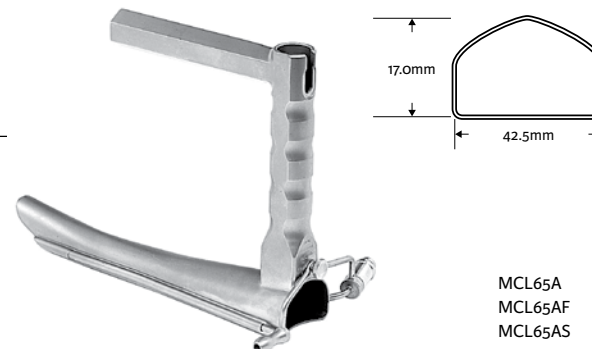

### Legent Laryngoscope

Catalog #	Description
MCL51	Medium, Overall length 150mm (5 <sup>7</sup> / <sub>8</sub> " Proximal Opening 25.0 x 16.5mm
MCL53	Fiberoptic Light Source, 3.0mm O.D., for MCL51
MCL52	Large, Overall length 170.0mm (6 <sup>3</sup> / <sub>4</sub> " Proximal Opening 25.0 x 16.5mm
MCL54	Fiberoptic Light Source, 3.0mm O.D., for MCL52

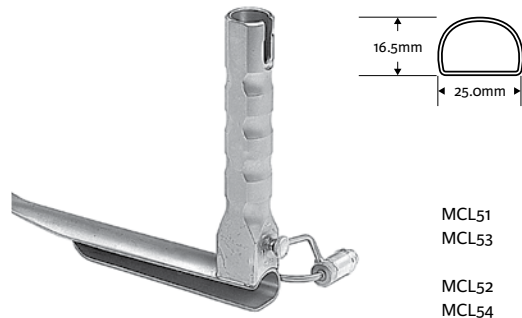

### Pignat Laryngoscope

Catalog #	Description
MCL63	Large, Overall length 200mm (7 <sup>3</sup> / <sub>4</sub> " Distal Opening 25.0 x 18.0mm Proximal Opening 45.0 x 14.0mm
MCL63F	Fiberoptic Light Source, 3.0mm O.D., for MCL63

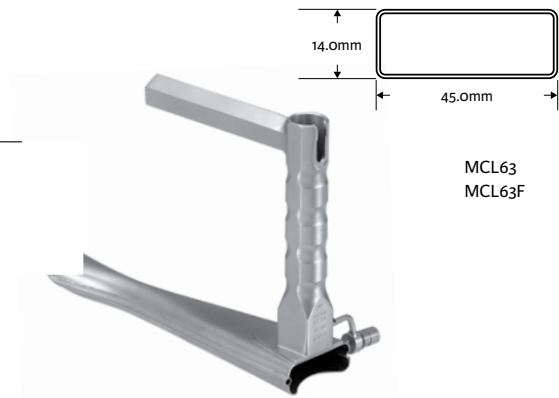

### Pignat Laryngoscope

Catalog #	Description
MCL64	Medium, Overall length 147mm (5 <sup>3</sup> / <sub>4</sub> " Distal Opening 21.0 x 14.0mm Proximal Opening 39.0 x 14.0mm
MCL64F	Laryngeal Suction, 3.0mm O.D. for MCL64

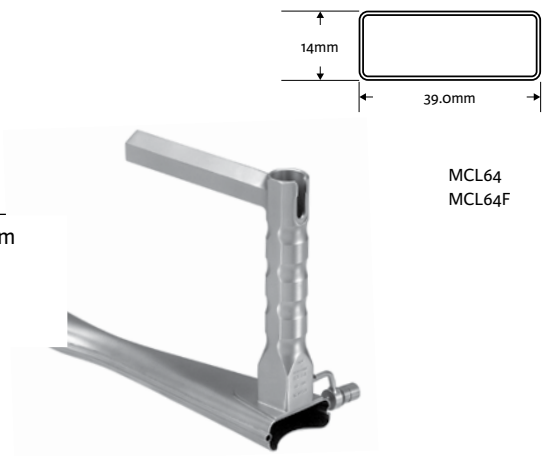

### Olympus Fiberoptic Light Source Adapter

Catalog #	Description
MCL197	Light Source Adapter



### Wolf Fiberoptic Light Source Adapter

Catalog #	Description
MCL170	Light Source Adapter



### Fiberoptic Endoscope Adapter

Catalog #	Description
MCL174	Endoscope Adapter

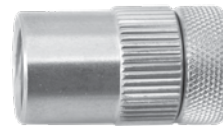

### Moriniere Mouth Gag Set

Overall length 315mm (12½")

Catalog #	Description
MCL206**	Complete with 5 Blades

Set consists of the following;

Catalog #	Description
MCL206A1	35.0mm, Open Tongue Blade
MCL206A2	35.0 x 12.0mm, Solid Tongue Blade
MCL206A3	35.0 x 10.0mm, Solid Tongue Blade
MCL206A4	40.0 x 8.0mm, Solid Tongue Blade
MCL206A5	35.0 x 7.0mm, Solid Tongue Blade
MCL206C	160 x 270mm, Frame Only
MCL206K	Key Tightening Handle
MCL206P	Blade Holder

\*\*Not for sale outside US

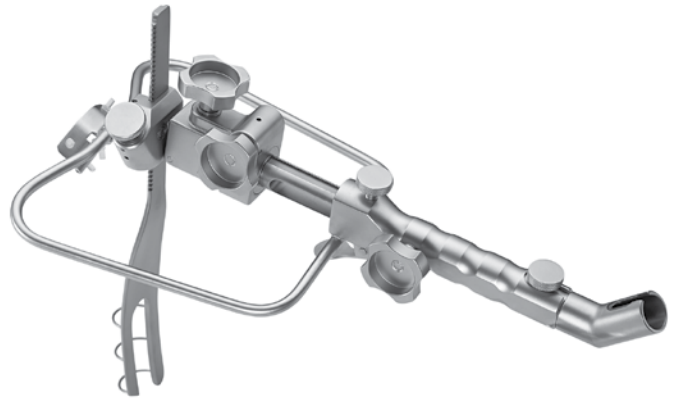

MCL206A1



MCL206A2



MCL206A3



MCL206A4



MCL206A5

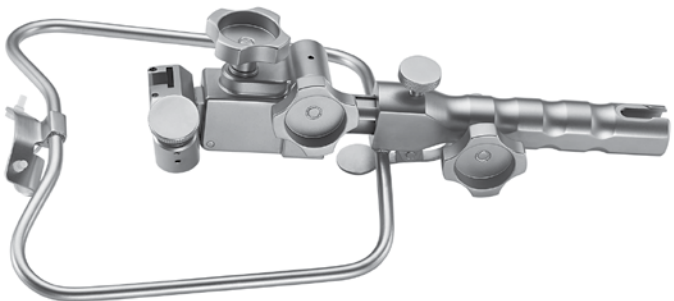

MCL206C



MCL206K



MCL206P

**PROBES**

**Lowinger Laryngeal Probe**

Double-Ended

Catalog #	Description
MCL101	Large, 280mm (11")
MCL102	Small, 260mm (10¼")

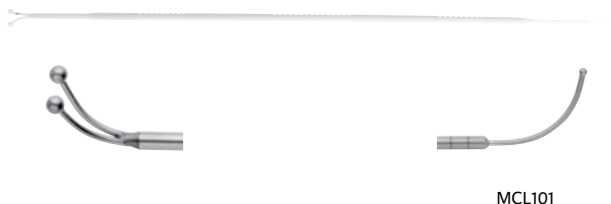

**RETRACTORS**

**Retractor**

Overall length 330mm (13")

Catalog #	Description
MCL48	6.6mm Wide Blunt Tips



**SCISSORS**

**Micro Scissors**

Catalog #	Description
MCL11	5.0mm, Straight Blades, Working length 222mm (8¾")
MCM7BISR	5.0mm, Straight Blades, Working length 150mm (5⅞")



**Woo Laryngeal Scissors**

Working length 202mm (8")

Catalog #	Description
MCLW10	5.0mm, Straight Blades
MCLW11	5.0mm, Angled-Up Blades 30°



### Brasnu Suction Tube

Working length 230.0mm (9")

Catalog #	Description
MCL100	2.0mm I.D., Angled 160°

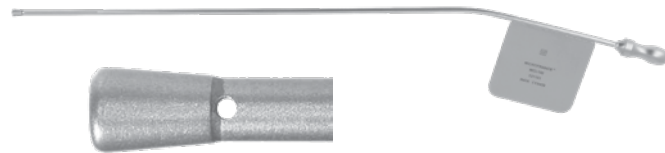

### Garabedian Suction Tube

Working length 229mm (9")

Catalog #	Description
MCL100T15	1.1mm I.D., Angled 160°
MCL100T20	1.5mm I.D., Angled 160°



MCL100T20

### Monopolar Suction Tube

Working length 240mm (9½")

Catalog #	Description
MCL62	2.0mm I.D., Angled 25°



### Suction Tube Cannula

Catalog #	Description
MCL920L25	3.0mm O.D., Angled 120°, 305mm (12")
MCL920L30	3.0mm O.D., Angled 120°, 355mm (14")
MCL920L35	3.0mm O.D., Angled 120°, 405mm (16")
MCL920L45	3.0mm O.D., Angled 120°, 505mm (20")
MCL920L55	3.0mm O.D., Angled 120°, 605mm (23¾")
MCL925L25	3.5mm O.D., Angled 120°, 305mm (12")
MCL925L30	3.5mm O.D., Angled 120°, 355mm (14")
MCL925L35	3.5mm O.D., Angled 120°, 405mm (16")
MCL925L45	3.5mm O.D., Angled 120°, 505mm (20")
MCL925L25	3.5mm O.D., Angled 120°, 605mm (23¾")
MCL930L25	4.0mm O.D., Angled 120°, 305mm (12")
MCL930L30	4.0mm O.D., Angled 120°, 355mm (14")
MCL930L35	4.0mm O.D., Angled 120°, 405mm (16")
MCL930L45	4.0mm O.D., Angled 120°, 505mm (20")
MCL930L55	4.0mm O.D., Angled 120°, 605mm (23¾")



MCL920L25

MCL930L25



### Suction Tube Cannula

Catalog #	Description
MCL935L25	4.5mm O.D., Angled 120°, 305mm (12")
MCL935L30	4.5mm O.D., Angled 120°, 355mm (14")
MCL935L35	4.5mm O.D., Angled 120°, 405mm (16")
MCL935L45	4.5mm O.D., Angled 120°, 505mm (20")
MCL935L55	4.5mm O.D., Angled 120°, 605mm (23¾")
MCL940L25	5.0mm O.D., Angled 120°, 305mm (12")
MCL940L30	5.0mm O.D., Angled 120°, 355mm (14")
MCL940L35	5.0mm O.D., Angled 120°, 405mm (16")
MCL940L45	5.0mm O.D., Angled 120°, 505mm (20")
MCL940L55	5.0mm O.D., Angled 120°, 605mm (23¾")



### Huttenbrink Suction Tube

Overall length 265mm (10½")

Catalog #	Description
MCL103	3.0mm Diameter



### Cotton Applicator

Catalog #	Description
7719-2	1.3 x 15.2mm, 145mm (5½")



### Gilbert O'Brien Approximator

Catalog #	Description
MCM13	Large
MCM13-1	Small

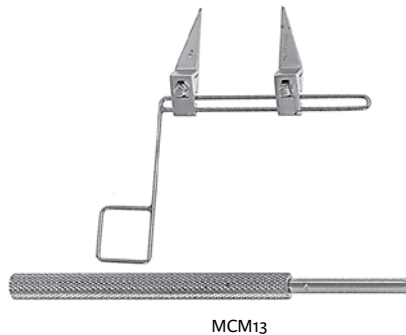

### Parsons Laryngeal Sprinkler

Overall length 230mm (9")

Catalog #	Description
MCL98	1.5mm Diameter



### Garabedian Tungsten-Carbide Needle Holder

Working length 233mm (9¼")

Catalog #	Description
MCL94G	2.7 x 7.0mm Jaw, W/Cleaning Port



**Garabedian Needle Holder Insert Only**

Working length 190mm (7½")

Catalog #	Description
MCL94IG	1.8 x 4.5mm Jaws, Straight



**Perouse Needle Holder Insert Only**

Working length 220mm (8¾")

Catalog #	Description
MCL94IP	1.3 x 7.0mm Jaws, Curved Left
MCL94IPR	1.3 x 7.0mm Jaws, Curved Right





INTEGRA<sup>®</sup>

LIMIT UNCERTAINTY



Integra<sup>®</sup> MicroFrance<sup>®</sup>

Maxillofacial Instruments

## Burrs

Catalog #	Description
141P23*	2.3mm, 6-Sided, 6/Box
141P27*	2.7mm, 6-Sided, 6/Box
141P31*	3.1mm, 6-Sided, 6/Box
141RS-3-1	3.1mm, 6-Sided
141RS-4-0	4.0mm, 6-Sided
141RS-5-0	5.0mm, 6-Sided



141P31

\*Not for sale in US

## Burrs, Cutting

Catalog #	Description
236RS-1-4	1.4mm
236RS-1-8	1.8mm
236RS-2-3	2.3mm
236RS-3-1	3.1mm
236RS-3-5	3.5mm
236RS-4-0	4.0mm
236RS-4-5	4.5mm
236RS-5-0	5.0mm
236RS-6-0	6.0mm
236RS-7-0	7.0mm



236RS-3-5

### Burrs, Diamond

Catalog #	Description
242-0-6	0.6mm
242-0-7	0.7mm
242-0-8	0.8mm
242-1-0	1.0mm
242-1-4	1.4mm
242-1-8	1.8mm
242-2-3	2.3mm
242-2-7	2.7mm
242-3-1	3.1mm
242-3-5	3.5mm
242-4-0	4.0mm
242-4-5	4.5mm
242-5-0	5.0mm
242-6-0	6.0mm
242-7-0	7.0mm



### Burrs, Tungsten-Carbide

Catalog #	Description
236HM-0-6	0.6mm
236HM-0-8	0.8mm
236HM-1-0	1.0mm
236HM-1-4	1.4mm
236HM-1-8	1.8mm
236HM-2-3	2.3mm
236HM-2-7	2.7mm
236HM-3-0	3.0mm
236HM-3-5	3.5mm
236HM-4-0	4.0mm
236HM-4-5	4.5mm
236HM-5-0	5.0mm
236HM-7-0	7.0mm



### Drill/Burr

Catalog #	Description
2035512C4*	1.2mm, 55m (2 1/8"), 4/Pkg
2035515C4*	1.5mm, 55m (2 1/8"), 4/Pkg



\*Not for sale in US

### Hand Drill

Catalog #	Description
7776	For Lemoine Drill/Burr



### Lemoine Drill/Burr

Catalog #	Description
7777	2.0mm Drill/Burr, 83mm (3 1/4")



### Lindemenn Drill/Burr

Catalog #	Description
164RS-1-8	1.8mm
168RS	2.3mm



### Lemoine Nails

Catalog #	Description
7778	2.0 x 16.0mm, 30.2mm Long
7778-1	2.0 x 11.0mm, 25.7mm Long

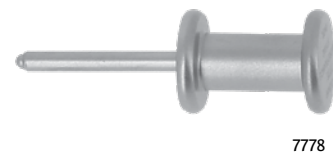

### Klossek Nails

Catalog #	Description
7778K	2.0 x 15.0mm, 24.9mm Long
7778K1	2.0 x 11.2mm, 20.6mm Long

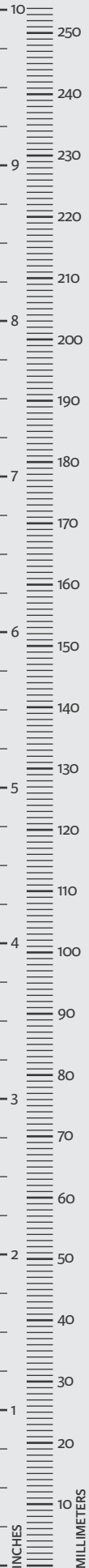
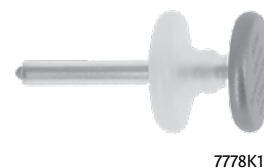



**ELEVATORS**

**Obwegeser Flat Periosteal Elevator**

Catalog #	Description
CP344A	4.5mm, Light Curve, 177.0mm (7")
CP344B	6.7mm, Light Curve, 177.0mm (7")
CP344C	10.3mm, Light Curve, 177.0mm (7")
CP344D	7.3mm, Light Curve, 193.0mm (7½")
CP344E	7.3mm, Curved, 193.0mm (7½")



CP344A

**Obwegeser-Tessier Flat Periosteal Elevator**

Catalog #	Description
CP344AT	4.5mm, Light Curve, 177mm (7")
CP344BT	6.7mm, Light Curve, 177mm (7")
CP344CT	10.3mm, Light Curve, 177mm (7")
CP344DT	7.3mm, Light Curve, 193mm (7½")
CP344ET	7.3mm, Curved, 193mm (7½")



CP344CT

**FORCEPS**

**Tessier Dissecting Forceps**

Catalog #	Description
CP928	1.5mm, Serrated, 130mm (5½")

**Tessier Disimpaction Forceps**

Catalog #	Description
CP521	Small Expansion, 168mm (6½")



**OSTEOTOMES**

**Tessier Osteotome**

Overall Length 185mm (7¼")

Catalog #	Description
CP316	4.0mm, Straight, Guarded



## RETRACTORS

### Obwegeser Channel Retractor

Catalog #	Description
CP501B	6.4mm Tip, 134mm (5¼")



### Obwegeser Soft Tissue Retractor

Catalog #	Description
CP963-1	16.0 x 90.0mm, Curved Down
CP963-2	30.0 x 152.0mm, Curved Down

## SCISSORS

### Tessier Dissecting Scissors

Catalog #	Description
CP364	Curved, 122mm (4¾")



## MISCELLANEOUS

### Obwegeser Mandibular Awl

Catalog #	Description
CP522	Curved, 145mm (5¾")

INTEGRA<sup>®</sup>  
LIMIT UNCERTAINTY



# Integra<sup>®</sup> MicroFrance<sup>®</sup>

## Otology Instrumentation

## California Ear Institute Ossiculoplasty Sizer Set

Overall length 153mm (6")

Catalog #	Description
MCOR15**	CA Ear Institute Ossiculoplasty Sizer Set

Set consist of the following;

Catalog #	Description
MCOR20	Ossiculoplasty Sizer, 2.0mm
MCOR25	Ossiculoplasty Sizer, 2.5mm
MCOR30	Ossiculoplasty Sizer, 3.0mm
MCOR35	Ossiculoplasty Sizer, 3.5mm
MCOR40	Ossiculoplasty Sizer, 4.0mm
MCOR45	Ossiculoplasty Sizer, 4.5mm
MCOR50	Ossiculoplasty Sizer, 5.0mm
MCOR55	Ossiculoplasty Sizer, 5.5mm
MCOR60	Ossiculoplasty Sizer, 6.0mm
MCOR65	Ossiculoplasty Sizer, 6.5mm
MCOR70	Ossiculoplasty Sizer, 7.0mm
MCOR75	Ossiculoplasty Sizer, 7.5mm
MCOR80	Ossiculoplasty Sizer, 8.0mm
3717022	Instrument Tray



Closed



Open

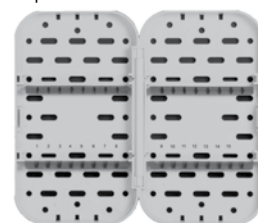

3717022

\*\*Not for sale outside US

### J.B. Causse Middle Ear Instrument Set

Developed in conjunction with Jean-Bernard Causse, MD

Catalog #	Description
MCO649*	J.B. Causse Middle Ear Instrument Set

Set consist of the following;

Catalog #	Description
MCO12D	Measuring Instrument, 4.0mm Tip, 60mm (2 <sup>3</sup> / <sub>8</sub> " )
MCO13C	Hartman Alligator Forceps, Fine, 3.0mm, 71mm (2 <sup>3</sup> / <sub>4</sub> " )
MCO213-4	Graduated Prosthesis Cutting Block, 11.0 x 117.0mm
MCO27	Dieters Malleus Nipper, Small, 75mm (3")
MCO4A	Micro Scissors, 2.0mm Blades, 71mm (2 <sup>3</sup> / <sub>4</sub> " )
MCO649SC	Instrument Tray, 9 <sup>3</sup> / <sub>4</sub> " W x 20 <sup>3</sup> / <sub>4</sub> " L x 3 <sup>7</sup> / <sub>8</sub> " D
MCO651	Canal Knife, V-Shape, Angled, 3.0mm Blade, 162mm (6 <sup>1</sup> / <sub>2</sub> " )
MCO652	Canal Knife, Round, Angled, 3.0mm Blade, 164mm (6 <sup>1</sup> / <sub>2</sub> " )
MCO655	Bone Curette, 2.0mm Cup, 160mm (6 <sup>1</sup> / <sub>4</sub> " )
MCO656	Incudostapedial Joint Knife, 0.65mm, 165mm (6 <sup>1</sup> / <sub>2</sub> " )
MCO657	Pick, Curved, 3.0mm, 157mm (6 <sup>1</sup> / <sub>4</sub> " )
MCO658	Forceps, Fine Cupped, Piston, 71mm (2-3/4")
MCO660-10*	Vein Preparation Plate, 1.0mm Hole, 2 <sup>1</sup> / <sub>2</sub> " x 2 <sup>1</sup> / <sub>2</sub> " x 4.0mm
MCO664	Hook, Perpendicular, Short Hook, Angled Up, 161mm (6 <sup>1</sup> / <sub>4</sub> " )
MCO665	Hook, Perpendicular, Long Hook, Angled Up, 163mm (6 <sup>1</sup> / <sub>2</sub> " )
MCO666	Pick, Curved, Semi-Sharp, 3.0mm Tip, 162mm (6 <sup>1</sup> / <sub>2</sub> " )
MCO667	Elevator, 2.0 x 3.0mm, Angled Tip, 165mm (6 <sup>1</sup> / <sub>2</sub> " )
MCO820	Martin Vein Press, 20.0mm Press Area

\*Not for sale in US



## J. B. Causse Middle Ear Instrument Accessories

### Causse Glass Plate

67mm, (2<sup>5</sup>/<sub>8</sub>" ) x 67mm (2<sup>5</sup>/<sub>8</sub>" )

Catalog #	Description
MCO660-2*	Glass Plate, Plain
MCO660-8*	Glass Plate, 0.8mm Hole
MCO660-10*	Glass Plate, 1.0mm Hole
MCO660-12*	Glass Plate, 1.2mm Hole

\*Not for sale in US



MCO660-10

## J. B. Causse Instrument Tray

Catalog #	Description
MCO670-1	33.7cm L x 19.7cm W x 7.5cm D (9 <sup>3</sup> / <sub>4</sub> " L x 5 <sup>3</sup> / <sub>4</sub> " W x 3" D)

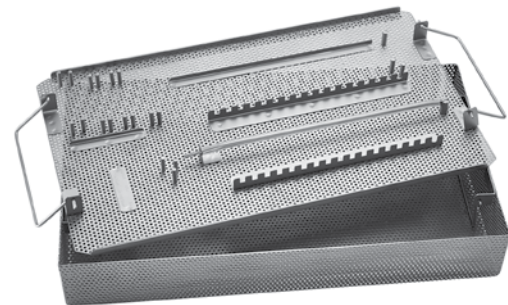



### House Otology Instrument Set

Developed in conjunction with John House, MD, of the House Ear Institute

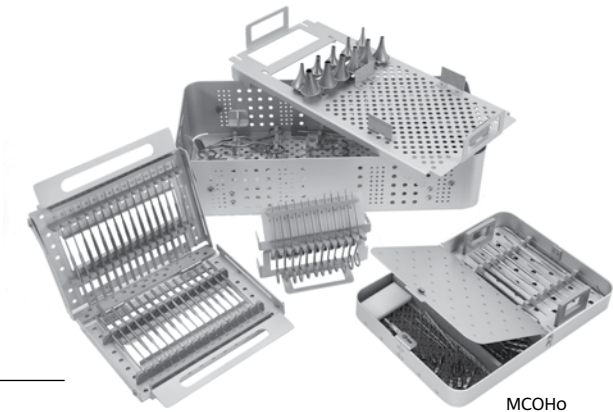

MCOHo

Catalog #	Description
MCOHo**	House Otology Instrument Set

Set consist of the following;

Catalog #	Description
MCO10	Sickle Knife, Overall Length 165mm (6½")
MCO205	Footplate Hook, 0.3mm, 165mm (6½")
MCO6B	Hook, 90°, 0.7mm, 165mm (6½")
MCO6	Plester Flat Micro Knife, 165mm (6½")
MCO7A-1	Curette, Angled, Double-Ended, Size 1, 2
MCO7A-3	Curette, Angled, Double-Ended, Size 3, 4
MCO805A	Hook, Ball-Tipped, 2.5mm, 165mm (6½")
MCO807	Hook, Blunt, 45°, 1.0mm, 165mm (6½")
7781	Beckman Retractor, 3 x 4 Teeth, 165mm (6½")
MCO13A	Hartmann Alligator Ear Forceps, 4.0mm, 125mm (4¾")
MCO21	Micro Cupped Forceps, 1.0mm, 125mm (4¾")
MCO21H	Micro Cupped Forceps, 2.5mm, 130mm (5⅛")
MCEN50	Rouvier Elevator & Knife, S/B Ends, 185mm (8¼")
MCO27	Dieters Malleus Nipper, Small, 75mm (3")
MCO313	Rosen Knife, 135°, 3.4mm, 165mm (6½")
MCO32	Needle, Slightly Curved, 0.35mm Tip, 165mm (6½")
MCO4	Micro Scissors, Straight, 4.0mm Blades, 125mm (5")
MCO4A	Micro Scissors, Straight, Delicate, 3.0mm Blades, 125mm (5")

\*\*Not for sale outside US



MCEN50



MCO10

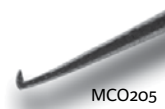

MCO205



MCO5A-1-0  
MCO5A-2-0  
MCO5A-2-5



MCO6B



MCO6



MCO7A-1  
MCO7A-3



MCO805A



MCO807



7781



MCO13A



MCO21



MCO21H



MCO27



MCO313



MCO32



MCO4  
MCO4A

## House Otology Instrument Set, Continued

Baron Suction Tubes  
Working length 75mm (3")

Catalog #	Description
3724172	Regular, 3 French
3724173	Regular, 5 French
3724175	Regular, 7 French

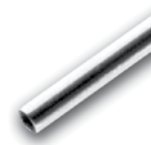

3724173

Farrior Specula, Oval

Catalog #	Description
3724108	Size 1 (4.5 x 6.0mm)
3724109	Size 2 (5.5 x 7.0mm)
3724110	Size 3 (6.5 x 8.0mm)
3724111	Size 4 (7.5 x 9.0mm)
3724112	Size 5 (8.0 x 10.0mm)
3724113	Size 6 (9.0 x 11.25mm)
3724114	Size 7 (10.0 x 12.5mm)



3724111

Guilford-Wright Suction Tubes  
Working length 105mm (4 1/8")

Catalog #	Description
3724214	22 Gauge
3724215	24 Gauge
3724216	House Cutoff Adapter, 50mm (2")



3724214



3724216





**House Otology Instrument Set, Continued**

Hartmann Specula, Round  
Working length 105mm (4 1/8")

Catalog #	Description
3724141	Size 1 (4.0mm)
3724142	Size 2 (5.0mm)
3724143	Size 3 (6.0mm)
3724144	Size 4 (7.0mm)



3724143

House-Baron Suction Tubes, Extra Long  
Working length 100mm (3 7/8")

Catalog #	Description
3724177	3 French
3724178	5 French

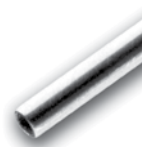

3724177

House-Bellucci Scissors, Fine  
Working length 87mm (3 3/8")

Catalog #	Description
3724083	5.0mm, Straight
3724084	5.0mm, Curved Left
3724085	5.0mm, Curved Right



3724083



3724084  
Left



3724085  
Right

## House Otology Instrument Set, Continued

House Suction Irrigators:  
Thumbplate with cutoff hole for suction

Catalog #	Description
3724218	2.5 x 4.0 French, 70mm (2¾")
3724219	2.5 x 4.0 French, 95mm (3¾")
3724220	4.5 x 5.0 French, 70mm (2¾")
3724221	4.5 x 5.0 French, 95mm (3¾")
3724222	5.0 x 7.0 French, 95mm (3¾")
3724223	6.0 x 8.0 French, 95mm (3¾")
3724224	7.0 x 10.0 French, 95mm (3¾")
3724225	8.0 x 12.0 French, 95mm (3¾")
3724226	12.0 x 14.0 French, 95mm (3¾")

Miscellaneous:

Catalog #	Description
3722058	House Barbara Pick, 165mm (6½")
3722062	House Strut Pick, 90°, 0.5mm, 165mm (6½")
3722065	House-Hough Excavator, 0.33mm, 165mm (6½")
3724061	Sheehy Fascia Press, 21.0 x 31.0mm, 191mm (7½")
3740000	Knife Handle, #3, 125mm (4⅞")
3714019	Joseph Skin Hook, Single Prong, 160mm (6¼")
3722020	Footplate Hook, Angled 45°
3722037	House Lancet Knife #2, 2.0 x 3.0mm, 45°, 165mm (6½")
3722038	House-Sheehy Knife Curette, "Small Weapon" 2.0 x 3.0mm, 45°, 165mm (6½")
3722040	House Tympanoplasty Knife, 7.0mm Curved Blade, 165mm (6½")
3722042	House Incudostapedial Joint Knife, 0.5 x 1.5mm, 20°, 165mm (6½")
3722055	House Needle, Malleable, Semi-Sharp, Light Curve, 165mm (6½")
3724058	House-Billeau Ear Loop, 3.5mm Loop, 165mm (6½")
3722061	House Oval Window Pick, Malleable, 0.66mm, 90°, 165mm (6½")
3722063	House Oval Window Pick, Malleable, 0.66mm, 30°, 165mm (6½")
3722117	House-Rosen Needle, Malleable, Semi-Sharp, 3.0mm Light Cvd, 165mm (6½")
3724003	Buck Ear Curette, Angled, Sharp, Size 1, 2.0mm, 152mm (6")
3724013	Buck Ear Curette, Angled, Blunt, Size 1, 2.0mm, 152mm (6")
3724282	Myringotomy Knife, 8.0mm Straight, 165mm (6½")



3724222



3722058



3722062



3722065



3724061



3740000



3714019



3722020



3722037



3722038



3722040



3722042



3722055

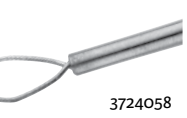

3724058



3722061



3722063



3722117



3724003



3724013



3724282

### House Otology Instrument Set, Continued

Catalog #	Description
3713001	Fomon Saber Back Scissor, Semi-Sharp Outer Edges, Curved, Tungsten Carbide Blades, 127mm (5")
3722046	Separator, Bayonet, 1.5mm, Curved Scraper
3722047	Separator, Bayonet, 1.25mm, Curved Scraper
3722048	House Elevator, "Gimmick", 1.0 x 12.0mm, Angled 15°, Overall length 160.0mm (6¼")
3722075	House Wire Strut Guide, 0.6mm, Notched Tip, Overall Length 165mm (6½")
3722078	House Strut Calipers, 4.0mm from Marker to Tip, Overall length 165mm (6½"), Malleable Shaft
3722079	House Strut Calipers, 4.5mm from Marker to Tip, Overall length 165mm (6½"), Malleable Shaft
3722115	Duckbill Elevator, 3.5mm, Slight Curve, Sharp Blade, Overall length 165mm (6½")
3741032	Stitch Scissors, Ribbon Type, Light Curved, Sharp Tips, Overall length 97mm (3⅞")
3741181	Iris Scissor, Curved, 25.0mm Blades, 105mm (4⅛")
3724060	Lempert Elevator, 7.0mm, Curved 184mm (7¼")
3753008	Spring Handle Scissor, 19.0mm, Straight, 149mm (5⅞")
1352247	House Retractor, 3-Blunt Prongs Right, Solid Blade Left, Overall length 165mm (6½")
1352248	House Retractor, 3-Blunt Prongs Left, Solid Blade Right, Overall length 165mm (6½")
3714783	House-Crabtree Dissector Pick, Angled 90°, Overall length 168mm (6½")
3721009	McGee Malleus Crimper, 3.5mm, Very Fine Jaws, Overall length 82mm (3¼")
3721014	Bellucci Alligator Forceps, 8.0mm Serrated Jaws, Overall length 87mm (3⅜")
3721025	House Alligator Ear Forceps, 6.0mm, Fine, Straight, Overall length 82mm (3¼")
3740025	Adson Tissue Forceps, 1 x 2 Teeth, Standard Pattern, Overall Length 121mm (4¾")
3714780	Dissector, 3mm Tip, 220mm (8¾")
3714781	Perkins Elevator, Forward Scratcher, 1.25 x 2.5mm, 20°, 168mm (6½")
3714782	Perkins Elevator, Back Scratcher, 1.25 x 2.5mm, 135°, 168mm (6½")



### House Otology Instrument Set, Continued

Catalog #	Description
3717025	Pick Tray, 24.8cm L x 22.1cm W x 4.5cm D, Holds 32 Picks (9¾" L x 8¾" W x 1¾" D)
3717026	Otology Tray, 52.7cm L x 25.4cm W x 18.2cm D (20¾" L x 10" W x 7¼" D)

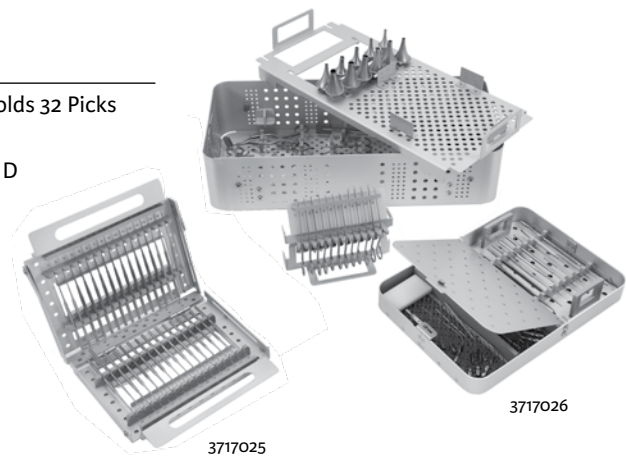

### Kraus TM MicroCut® Forceps

The Kraus TM MicroCut® Forceps were designed to help remove the epithelial edge of a tympanic membrane perforation without over-enlarging the existing perforation.

Useful during tympanic membrane patching, myringoplasty, and tympanoplasty procedures

Designed for precision edge cutting

Low profile rotation knob allows for universal 360° cutting ability and promotes visualization

Thumb-activated reverse-action handle allows for controlled movement and helps reduce distal tip motion

Distal tip basket captures resected tissue to help prevent tissue from entering the middle ear



Developed in conjunction with Eric M. Kraus, MD, MS, FACS

Catalog #	Description
MCO270	Kraus TM MicroCut® Forceps, 90° Up-Biting
MCO271	Kraus TM MicroCut® Forceps, Forward-Biting
MCO272	Kraus TM MicroCut® Forceps, Backward-Biting

### Selesnick Lateral Skull Base Set

The MicroFrance® Selesnick Lateral Skull Base Set comprises 24 different instruments designed for dissection in skull base surgery.

The instruments have slim profiles to promote access, feature a working length of 190mm, and offer a range of working tips to facilitate control and precision in difficult-to-reach areas.

Developed in conjunction with Samuel H. Selesnick, MD, FACS

Catalog #	Description
MCOS10**	Selesnick Lateral Skull Base Set

Set consist of the following;

Catalog #	Description
MCOS14	Selesnick Hook 45°, Semi-Sharp
MCOS15	Selesnick Hook 90°, Semi-Sharp
MCOS16	Selesnick Hook 90°, Blunt
MCOS17	Selesnick Dissector, Round 1.0mm
MCOS18	Selesnick Dissector, Round 2.0mm
MCOS19	Selesnick Dissector, Round 3.0mm
MCOS20	Selesnick Elevator, Angled
MCOS21	Selesnick Elevator, Curved
MCOS22	Selesnick Spatula-Dissector, Small
MCOS23	Selesnick Spatula-Dissector, Large
MCOS25	Selesnick Micro-Curette, Straight
MCOS26	Selesnick Micro-Curette, Angled
MCOS27	Selesnick Cup Forceps, 1.0mm
MCOS29	Selesnick Cup Forceps, 3.0mm
MCOS30	Selesnick Whirlybird Pick, Curved Left
MCOS31	Selesnick Whirlybird Pick, Curved Right
MCOS32	Selesnick Sickle Knife, 5.0mm

\*\*Not for sale outside US

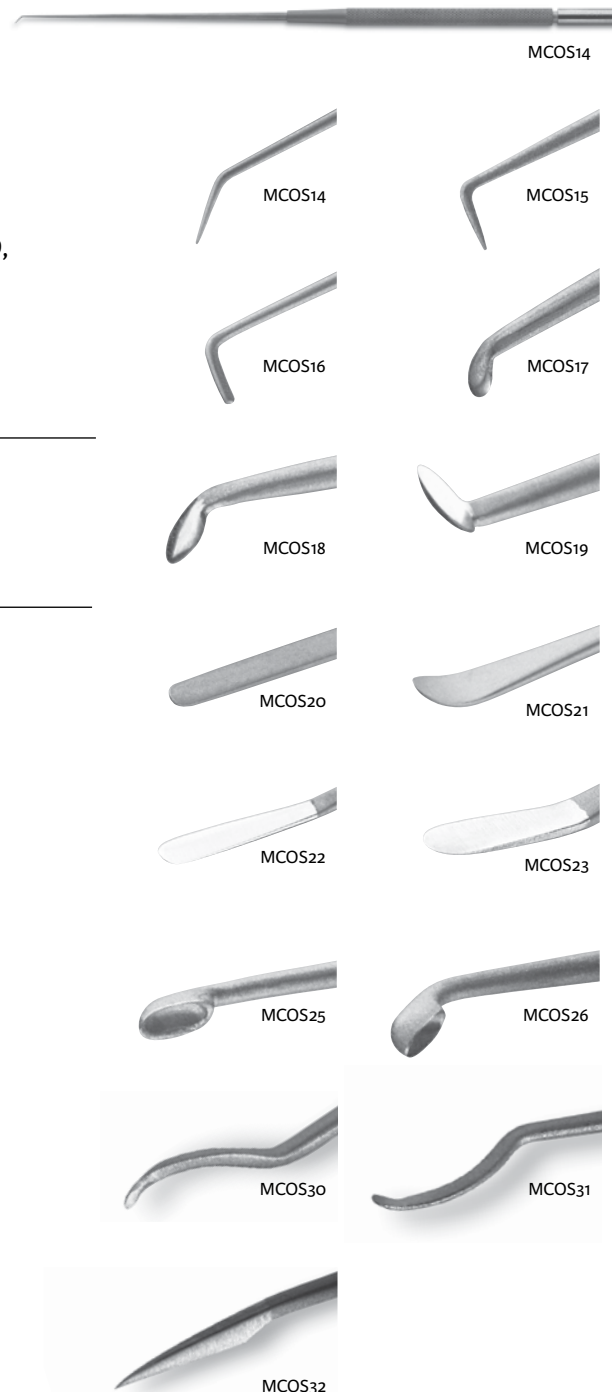

**Selesnick Lateral Skull Base Set (continued)**

Catalog #	Description
MCOS33	Selesnick Dissecting Scissors, Straight
MCOS34	Selesnick Dissecting Scissors, Curved Up
MCOS35	Selesnick Dissecting Scissors, Curved Left
MCOS36	Selesnick Dissecting Scissors, Curved Right
MCO291	Neurotology Coagulating Bipolar Forceps
MCO351	Angot-Vanecloo Retractor
CP393	Bifurcated (Banana Plug) Bipolar Cable
MCOS10SC	Instrument Tray, Two-Level 38.5cm L x 25.6cm W x 12.8cm D 15 1/4" L x 10" W x 5" D
3717022	Pick Tray, Plastic, Holds 16 Picks 21cm L x 12.3cm W x 3.6cm D 8 1/4" L x 4 7/8" W x 1 3/8" D

\*\*Not for sale outside US

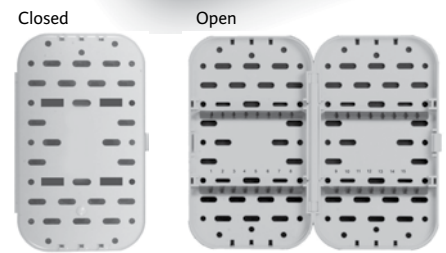
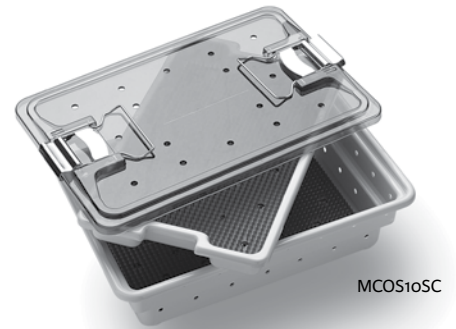
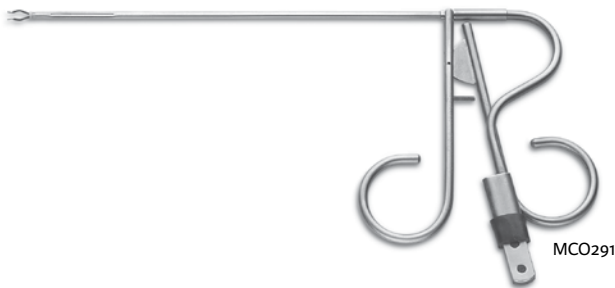

3717022





### Wiet Chronic Ear/Stapes Surgery Instruments

This microsurgical instrument set has a variety of otology instruments that will assist the surgeon to perform most ear surgeries. The set is composed of 21 microsurgical instruments, including the MicroFrance® “Golf Club” Elevators.

Developed in conjunction with Richard Wiet, MD

Catalog #	Description
3722020	Footplate Pick, Angled 45°
3722036	House Lancet Knife #1, 7.5mm, Curved Blade, 165mm (6-1/2")
3722037	House Lancet Knife #2, 2.0mm x 3.0mm, 45°, 152mm (6")
3722048	House “Gimmick Elevator”, 1.0mm x 12.0mm, 15°, 160mm (6-1/4")
3722056	Needle, Light Curve, Dull
3722058	House “Barbara Pick”, Straight, 155mm (6")
3722068	House Pick, 3.0mm, 90°, 160mm (6-1/4")
3722071	House “Crabtree Dissector Pick Jimmy”, 90°
3722113	Whirlybird Pick, Right, 1.0 x 4.0mm
3722114	Whirlybird Pick, Left, 1.0 x 4.0mm
3722122	Roller Knife, 3.0mm
3722136	Derlacki Mobilizer, Angled Tip
3722158	Harrison Knife, 45°
3724066	Perkins Retractor, Right
3724067	Perkins Retractor, Left
3724307	Allport Incus Hook, 90°
MCO37	Weit Micro Elevator “Golf Club,” Right
MCO37-1	Weit Micro Elevator “Golf Club,” Left
MCO38	Measuring Instrument



**Wiet Chronic Ear/Stapes Surgery Instruments (continued)**

Catalog #	Description
N480G	Wiet Bayonet Scissors
3717012	Instrument Tray, One-Level 38cm L x 25.5 cm W x 7.4 cm D (15" L x 10" W x 2 7/8" D)
3717022	Pick Tray, Plastic, Holds 16 Picks 21cm L x 12.3cm W x 3.6cm D 8 1/4" L x 4 7/8" W x 1 3/8" D

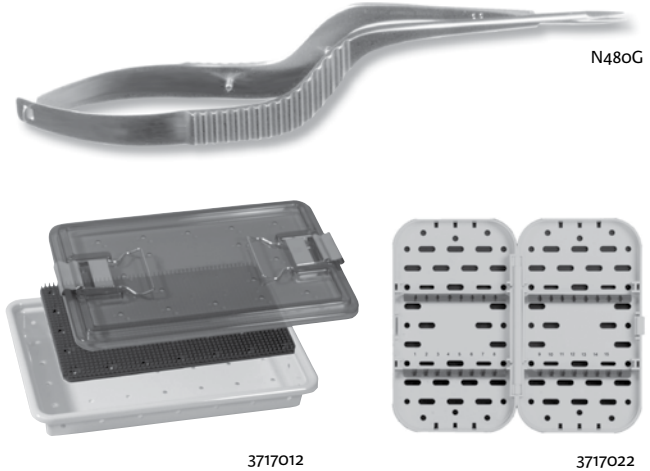

**CARTILAGE**

**Jost Cartilage Crusher**  
Overall Length 90mm (3 1/2")

Catalog #	Description
CP814-1	30.0 x 46.0mm Working Area

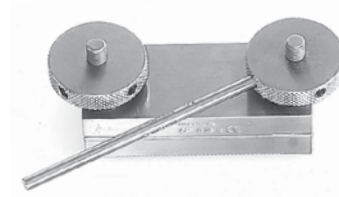

**Cartilage and Fascia Press**

Catalog #	Description
CP814-2	30.0 x 49.0mm Cartilage, Fascia Press
CP814-3	4.0 x 80.0mm Key for Press

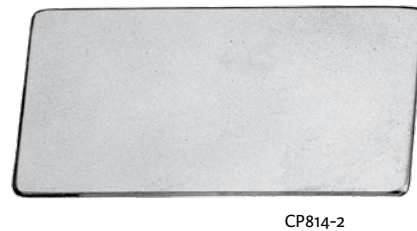

**Martin Cartilage Cutting Block**

Catalog #	Description
MCO250	28.0mm Cutting Width

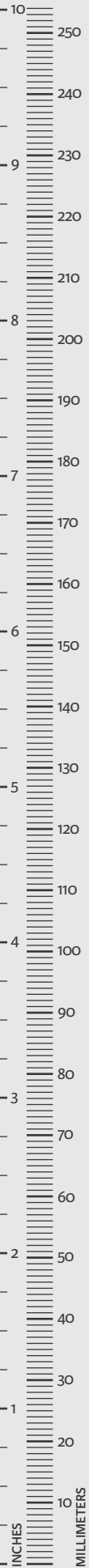
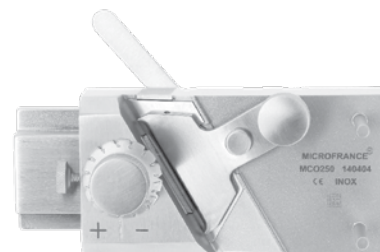



### Teixido Cartilage Cutter

The Teixido Cartilage Cutter provides a simple solution to preparing cartilage grafts for tympanoplasty and ossicular chain reconstruction procedures. This device slices cartilage in a standard thickness of 0.3mm in one swift motion. Working space for trimming and measuring the cartilage is also incorporated to facilitate graft preparation.

Minimum number of parts to clean

Angled, replaceable blade

0.3mm cartilage slice allows for 2-3 slices per tragus

Developed in conjunction with Michael Teixido, MD



MCO255



Catalog #	Description
MCO255	Teixido Cartilage Cutter with One Blade
MCO251*	Replacement Blades

\*Not for sale in US

### CHISELS

#### Chisel



Catalog #	Description
MCO2	1.3mm Wide Tip, 165mm (6 1/2")

#### Marquet Chisel



Catalog #	Description
MCO910M	0.4mm Wide Tip, 160mm (6 1/4")

### CURETTES

#### Double-Ended Curette

Overall length 160mm (6 1/4")



Catalog #	Description
MCO7A3	1.4 x 1.8mm, and 1.15 x 1.6mm Cups

### Ear Curette

Overall length 165mm (6½"), Double-Ended

Catalog #	Description
MCO7A-1	No. 1, 2.6 x 1.9mm, No. 2, 2.3 x 1.7mm Cups
MCO7A-3	No. 3, 1.8 x 1.4mm, No. 4, 1.6 x 1.15mm Cups
MCO7A-5	No. 5, 1.4 x 1.0mm, No. 6, 1.2 x 0.8mm Cups



MCO7A-3

### Fenestrated Curette

Overall length 165mm (6½")

Catalog #	Description
MCO207-1-5	1.8 x 1.5mm, Angled 40°
MCO207-2-0	2.5 x 2.0mm, Angled 40°



MCO207-2-0

### Middle Ear Curette

Overall length 165mm (6½"), Double-Ended

Catalog #	Description
MCO7-1	No. 1, 2.5 x 1.85mm, No. 2, 2.3 x 1.6mm Cups
MCO7-3	No. 3, 2.0 x 1.5mm, No. 4, 1.7 x 1.2mm Cups



MCO7-3

### MOM Curette

Overall length 188mm (7½"), Double-Ended

Catalog #	Description
MCO7AMO	No. 1, 3.0 x 2.0mm, No. 2, 2.6 x 1.75mm Cups



### Romanet Curette

Overall length 163mm (6½"), Double-Ended

Catalog #	Description
MCO7A6	No. 1, 2.5 x 1.75mm, No. 2, 2.0 x 1.3mm Cups

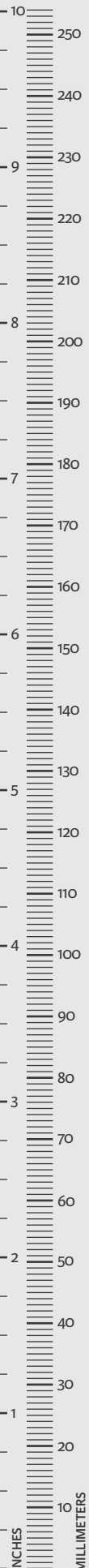

**Sterkers Curette**

Overall length 180mm (7")

Catalog #	Description
MCO320	3.35 x 8.0mm, Angled 15°
MCO321	4.0 x 8.0mm, Angled 10°
MCO322	6.0 x 12.0mm, Angled 10°



**Straight Curette**

Catalog #	Description
MCO818	2.4 x 3.2mm, 168mm (6½")



**ELEVATORS**

**Bayonet Elevator**

Overall length 179mm (7")

Catalog #	Description
MCO16	1.8 x 7.0mm, Curved Tip



**Bordure Monopolar Elevator**

Overall length 140mm (5½")

Catalog #	Description
MCO8BM	1.8mm, Curved Tip

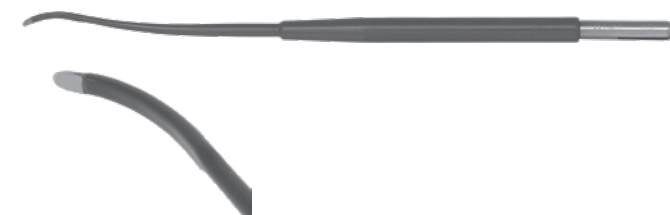

**Chobaut "Golf Club" Elevator**

Overall length 180mm (7"), Double-Ended

Catalog #	Description
MCO240	0.9mm Tips, 60° Angle



### Curved Suction Elevator

Working length 70mm (2¾")

Catalog #	Description
MCOP337A	1.7mm Tips, Curved 90°



### Dubreuil Elevator

Overall length 180mm (7")

Catalog #	Description
MCO337DL	1.65 x 5.5mm, Tip Curved Left 70°
MCO337DR	1.65 x 5.5mm, Tip Curved Right 70°



### Ear Elevator

Overall length 180mm (7")

Catalog #	Description
MCO210	0.7 x 3.5mm, Angled 120°
MCO8B	1.65 x 12.8mm, Curved

### Ear Raspatory

Overall length 165mm (6½")

Catalog #	Description
MCO224-2-0	2.0 x 2.0mm, Angled 80°
MCO224A-2-0	2.0 x 2.0mm, Angled 45°



MCO224A-2-0

### Fleury Elevator

Catalog #	Description
MCO803	2.5 x 22.5mm, 162mm (6½")
MCO979	6.8 x 20.0mm, 173mm (6¾")



MCO803

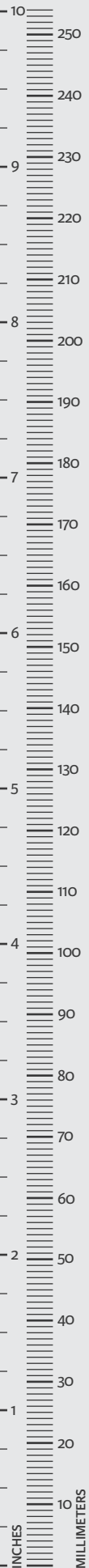

### Garabedian Elevator

Overall length 165mm (6½")

Catalog #	Description
MCO37D	1.0 x 10.0mm, Tip Angled 50°
MCO37G	1.1 x 4.3mm, Tip Angled 50°

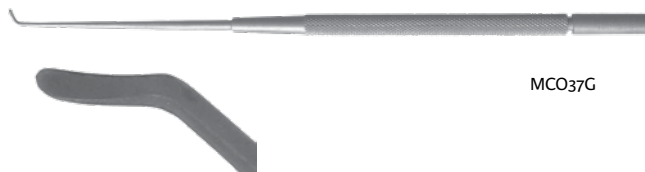

### Gentine Elevator

Overall length 175mm (7")

Catalog #	Description
MCO224G	4.3 x 7.0mm, Angled 45°



### House-Type "Gimmick" Elevator

Overall length 165mm (6½")

Catalog #	Description
MCO8	1.6mm x 13.5mm, Angled 15°



### Klap Elevator

Overall length 165mm (6½")

Catalog #	Description
MCO333	1.75 x 10.0mm, Curved, 195mm (7¾")



### Lerault Elevator

Overall length 195mm (7¾")



Catalog #	Description
MCEN103	2.7 x 15.0mm, Angled, Tip 15°

### Marquet Elevator

Overall length 165mm (6½")



Catalog #	Description
MCO904	1.3 x 2.5mm, Angled, Tip 90°
MCO905	3.2 x 3.0mm, Angled Right, Tip 90°
MCO906	3.1 x 4.0mm, Angled Left, Tip 90°

MCO906

### Marquet Elevator, Double-Ended

Overall length 178mm (7")



Catalog #	Description
MCO925	3.0 x 2.1mm, Curved, 3.1 x 0.8mm, Straight
MCO926	1.7 x 0.3mm, 0.8 x 4.0mm
MCO928	0.85 x 6.0mm, 0.85 x 5.0mm
MCO929	1.55 x 12.0mm, 1.45 x 12.0mm

MCO928

### Marquet Elevator, Double-Ended

Overall Length 170mm (6¾")



Catalog #	Description
MCO951	2.3 x 10.0mm, 2.2 x 10.0mm, Angled 40°



**Plester Elevator**

Overall length 181mm (7¼")

Catalog #	Description
MCO988	8.0 x 25.0mm



**Rosen Elevator**

Overall length 170mm (6¾")

Catalog #	Description
MCO14A	1.8 x 5.0mm, Angled Tip 160°

**Sebileau Elevator**

Catalog #	Description
MCO305	8.9 x 35.0mm, 179mm (7")



**Sulcus Elevator**

Catalog #	Description
MCO817	1.75 x 10.0mm, 165mm (6½")



**Thomassin Elevator**

Overall length 165mm (6½")

Catalog #	Description
MCO9-1	0.35 x 0.9mm, Angled 20°



**Weit Micro Elevator "Golf Club" Elevator**

Overall length 165mm (6½")

Catalog #	Description
MCO37	Micro Elevator, Right
MCO37-1	Micro Elevator, Left



MCO37-1

### Ear Separator

Overall length 165mm (6½")

Catalog #	Description
MCO209	1.3 x 0.8mm, Shaft Angled 45°



### Separator

Overall length 165mm (6½")

Catalog #	Description
MCO9	0.4 x 10.0mm, Tip Angled 90°



### FORCEPS

#### Dieter-Charachon Malleus Nipper

Working length 70mm (2¾")

Catalog #	Description
MCO222	1.9 x 3.0mm



#### Frayse Piston Closing Forceps

Working length 65mm (2½")

Catalog #	Description
MCO782L	0.7 x 4.0mm, Curved Left
MCO782R	0.7 x 4.0mm, Curved Right



MCO782L



### Hartman Alligator Micro-Forceps

Working length 70mm (2¾")

Catalog #	Description
MCO13B	1.6 x 8.0mm, Standard
MCO13D	1.3 x 6.0mm, Delicate
MCO13E	1.0 x 10.0mm, Fine
MCO22	8.0mm, 1 x 2 Teeth Serrated

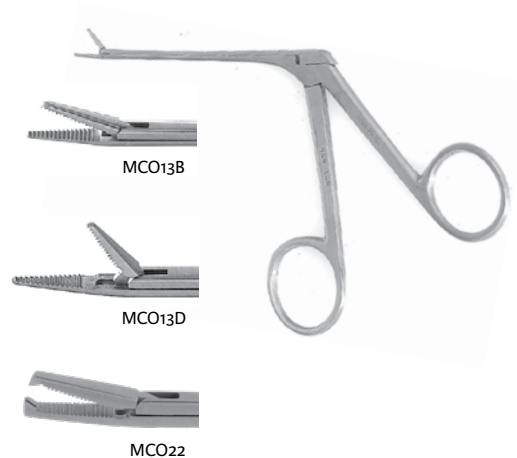

### Huttenbrink Metallic Piston Closing Forceps

Arcuated tip allows for wide opening  
Retaining spring in handle provides a passive opening mechanism to stabilize distal tip movement that may minimize the occurrence of incus luxation

Developed in conjunction with Michael Teixido, MD

Working length 65mm (2½")

Catalog #	Description
MCO25H	1.1mm x 3.0mm



### Lubet Barbon Forceps

Working length 108mm (4¼")

Catalog #	Description
7749	2.0 x 58.0mm, Smooth
7750	2.0 x 58.0mm, Serrated

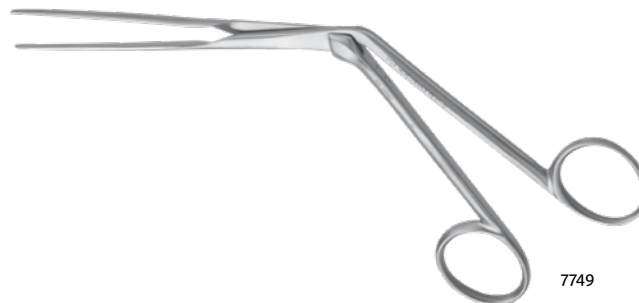

**McGee Crimping/Closing Forceps**

Working length 70mm (2¾")

Catalog #	Description
MCO25	0.8mm x 5.0mm



**Marquet Alligator Forceps**

Working length 70mm (2¾")

Catalog #	Description
MCO960	Right
MCO961	Left

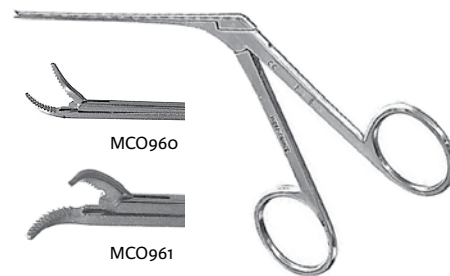

**Micro Alligator Forceps**

Working length 66mm (2⅝")

Catalog #	Description
MCO17	4.5mm Jaw, Straight
MCO24	5.0mm Jaw, Straight
MCO219B	5.0mm Jaw, Curved Right
MCO219C	6.0mm Jaw, Curved Up
MCO18A	2.8 x 4.0mm Jaw, Bayonet, Right



**Micro Alligator Forceps, W/Tube Shaft**

Working length 65mm (2½")

Catalog #	Description
MCO23	6.0mm Jaw, Straight, 81.0mm (3¼")
MCO23A	8.0mm Jaw, Straight, 100.0mm (3⅞")
MCO23B	6.0mm Jaw, Curved Right, 81.0mm (3¼")
MCO23A	6.5mm Jaw, Curved Up, 120.0mm (4¾")
MCO23B	7.0mm Jaw, Curved Up, 118.0mm (4⅞")



**Micro-Cupped Forceps**

Working length 65mm (2½")

Catalog #	Description
MCO21A	0.8mm, Straight
MCO21B	0.9mm, Curved Right
MCO21C	0.7mm, Curved Left
MCO21D	0.8mm, Angled Up 30°
MCO21F	0.6mm, Straight
MCO21G	1.8mm, Straight
MCO21H	0.6mm, Straight
MCO21I	1.6mm, Straight

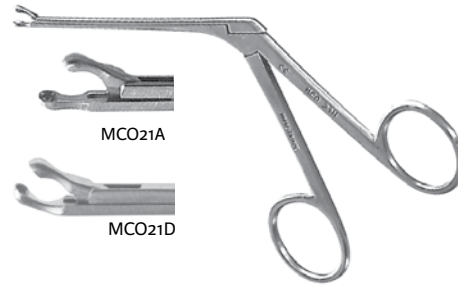

**Otology and Neurotology Bipolar Forceps**

The 2mm outer diameter and 1.5mm size of the tips makes them beneficial for coagulating in tight spaces  
Both bipolar forceps include a specially designed stainless steel instrument tray

Catalog #	Description
MCO290	Otology Bipolar Forceps and Tray Working Length 100mm (3⅞")
MCO291	Neurotology Bipolar Forceps and Tray Working Length 130mm (5⅛")
CP393	Bifurcated (Banana Plug) Bipolar Cable, 4.5m (14¾")



**Piston Closing Forceps**

Working length 67mm (2⅝")

Catalog #	Description
MCO26	0.9mm x 5.0mm, Jaws Straight
MCOP25	0.8mm x 5.0mm, Jaws Angled Down

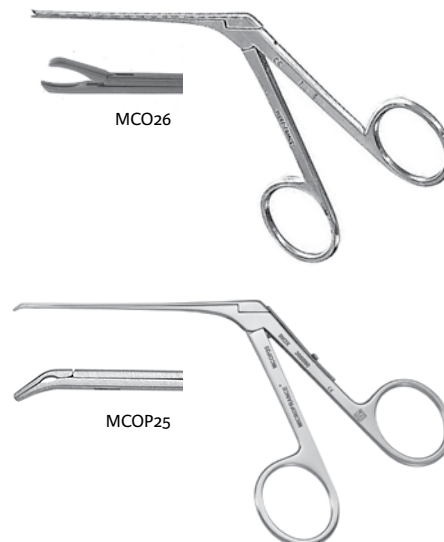

### Sterkers Alligator Micro-Forceps

Working length 98mm (3<sup>7</sup>/<sub>8</sub>" )

Catalog #	Description
MCO309	8.0mm Serrated Jaws



### T-Tube Insertion Forceps

Catalog #	Description
MCO781	2.3 x 7.0mm Jaw, 89mm (3 <sup>1</sup> / <sub>2</sub> " )



### Thomassin Alligator Forceps

Working length 62mm (2<sup>1</sup>/<sub>2</sub>" )

Catalog #	Description
MCO35	3.5 x 0.9mm, Serrated Jaw, Angled Down
MCO36	3.5 x 0.9mm, Cup Jaw, Angled Down



## GOUGES

### Flcury Gouges

Overall length 130mm (5<sup>1</sup>/<sub>8</sub>" )

Catalog #	Description
MCO214-13-10	1.3mm Wide
MCO214-13-20	2.3mm Wide
MCO214-13-40	4.4mm Wide
MCO214-13-60	6.5mm Wide
MCO214-13-80	8.9mm Wide

### Blunt Hook

Overall length 165mm (6½")

Catalog #	Description
MCO805	2.5mm, Angled 90°
MCO805A	3.0mm, Angled 90°

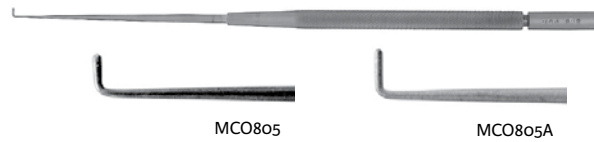

### Cause Hook

Overall length 165mm (6½")

Catalog #	Description
MCO654-1	1.25mm, Angled 95°
MCO654-2	1.25mm, Angled 95°
MCO841	1.4mm, Angled 90°
MCO662-1	0.4mm, Anterior
MCO662-2	0.4mm, Posterior
MCO663-1	0.2mm, Anterior
MCO663-2	0.2mm, Posterior

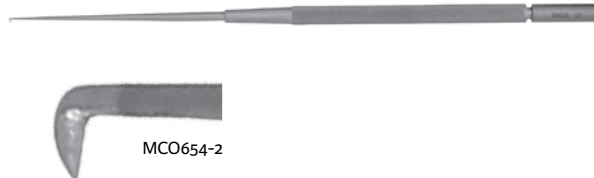

### Charachon Hook

Overall length 185mm (7¼")

Catalog #	Description
MCO806	2.3mm, Angled 55°
MCO806A	2.5mm, Angled 90°
MCO806B	4.0mm, Angled 90°

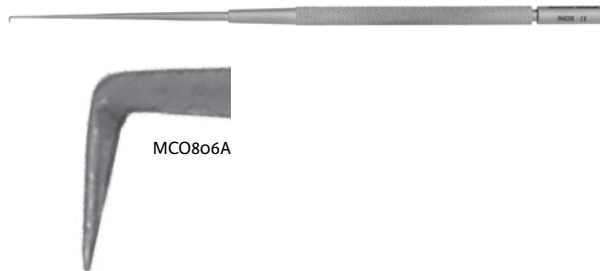

Overall length 165mm (6½")

Catalog #	Description
MCO832A	0.18mm, Posterior, Angled Shaft 25°
MCO832B	0.18mm, Anterior, Angled Shaft 25°
MCO832C	0.18mm, Angled Right, Angled Shaft 25°
MCO832D	0.18mm, Angled Left, Angled Shaft 25°
MCO833C	0.5mm, Angled Right, Angled Shaft 25°
MCO833D	0.5mm, Angled Left, Angled Shaft 25°



### Footplate Hook

Overall length 165mm (6½"), Angled Shaft 25°

Catalog #	Description
MCO205A	0.3mm, Posterior Hook
MCO205B	0.3mm, Anterior Hook
MCO205C	0.3mm, Angled Right 25°
MCO205D	0.3mm, Angled Left 25°



### Gillies Skin Hook

Catalog #	Description
CP17	3.4mm, Large, 182mm (7¼")
CP17-1	2.8mm, Small, 182mm (7¼")
CP17-2	3.4mm, Large, 148mm (5¾")
CP17-3	2.8mm, Small, 148mm (5¾")



### Legent Hook

Overall length 165mm (6½")

Catalog #	Description
MCO807	1.0mm, Angled 50°



### Magnan Hook

Working length 85mm (3¾"), Bayonet

Catalog #	Description
MCO340	2.0 x 0.7mm, Angled Right 90°
MCO341	2.0 x 0.7mm, Angled Left 90°



### Marquet Hook

Overall length 165mm (6½"), Angled Shaft 20°

Catalog #	Description
MCO915	2.0 x 11.0mm, Anterior, Angled Tip 90°
MCO916	2.0 x 11.0mm, Posterior, Angled Tip 90°
MCO920	0.35 x 0.9mm, Anterior, Angled Tip 50°
MCO950	0.25 x 0.76mm, Straight, Angled Tip 90°

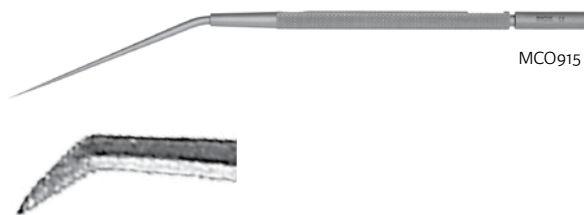

### Poncet Hooks

Overall length 170mm (6¾"), Angled Shaft 20°

Catalog #	Description
MCO226	0.5mm, Anterior
MCO226A	0.5mm, Posterior
MCO226B	0.5mm, Angled Right 90°
MCO226C	0.5mm, Angled Left 90°



### Portmann Hooks

Working length 80mm (3⅛")

Catalog #	Description
MCO971T	8.0mm, Anterior, Angled Tip 90°
MCO972	8.0mm, Posterior, Angled Tip 90°
MCO973T	3.0mm, Anterior, Angled Tip 90°
MCO974	3.0mm, Posterior, Angled Tip 90°

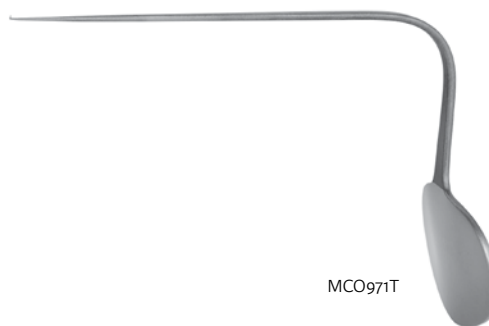

### Sterkers Hooks

Overall length 180mm (7")

Catalog #	Description
MCO302	0.5 x 2.3mm, Angled 90°
MCO303	0.5 x 1.7mm, Angled 90°
MCO304	0.35 x 1.05mm, Angled 90°
MCO812	0.3mm, Blunt Tip, Angled 90°



### Thomassin Hook

Overall length 165mm (6½")

Catalog #	Description
MCO804	0.25 x 0.8mm, Curved, Angled Tip 90°



### KNIVES

### Cause Ear Knife

Overall length 165mm (6½")

Catalog #	Description
MCO650	3.0mm, Ear, Angled Tip 90°
MCO651	2.8mm, Lancet, Angled Tip 45°
MCO652	3.0mm, Ear, Angled Tip 110°
MCO653	3.0mm, Lancet, Angled Tip 45°

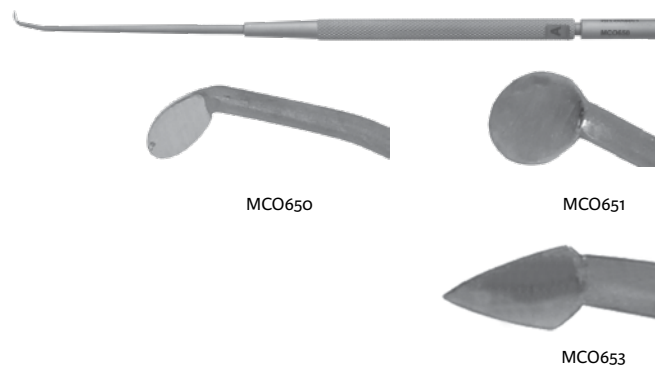

### Ear Knife

Overall length 160mm (6¼"), Double-Ended

Catalog #	Description
MCO312	1.4 x 4.0mm Sickle Blade, 2.6 x 3.1mm Joint Blade



### Ear Knife

Overall length 165mm (6½")

Catalog #	Description
MCO204B	2.0 x 2.75mm, Angled 135°
MCO317	2.0 x 2.7mm, Angled 135°



### Cause Ear Knife

Overall length 165mm (6½")

Catalog #	Description
MCO5	2.8 x 3.5mm, Angled Tip 30°
MCO5B	2.7 x 2.5mm, Angled Tip 90°
MCO5C	2.5 x 3.3mm, Straight, Angled Tip 45°



MCO5C

### Ear Knife

Overall length 165mm (6½")

Catalog #	Description
MCO5A-1-0	1.0 x 1.25mm, Angled 45°
MCO5A-1-5	1.5 x 2.2mm, Angled 45°
MCO5A-2-0	2.0 x 2.8mm, Angled 45°
MCO5A-2-5	2.5 x 3.4mm, Angled 45°



MCO5A-1-5

### Ear Lancet Knife

Catalog #	Description
7721-1	3.0mm Tapered, 170mm (6¾")

### Frayse Lancet Knife

Overall length 165mm (6½")

Catalog #	Description
MCO651F	2.1 x 5.5mm, Angled 90°



### Josephson Round Knife W/Suction

Developed in conjunction with Gary D. Josephson, MD  
Overall length 180mm (7")

Catalog #	Description
MCO5D	2.0mm Diameter
MCO5E	3.0 mm Diameter



### Jost Lancet Knife

Catalog #	Description
MCO2o4C	0.8 x 5.0mm Tapered, 165mm (6½")



### Lancet Knife

Overall length 175mm (7")

Catalog #	Description
MCOP651	2.8mm Tapered



### Lancet Knife

Overall length 195mm (7¾")

Catalog #	Description
MCOP347A	5.5mm Tapered
MCOP347B	7.0mm Tapered
MCOP348A	5.0mm Tapered
MCOP348B	7.0mm Tapered
MCOP348C	9.0mm Tapered
MCOP348D	11.0mm Tapered



### Marquet Knife

Overall length 165mm (6½")

Catalog #	Description
MCO932	3.6 x 4.0mm, Angled 45°

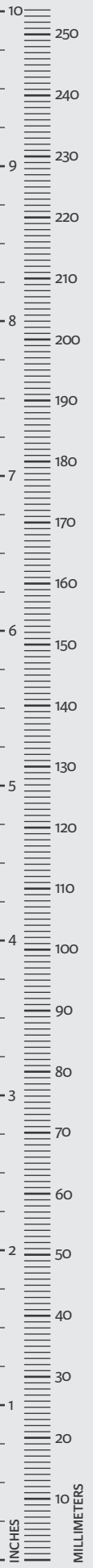

**MOM Flap Knife W/Suction**

Catalog #	Description
MCO6M	1.5mm O.D., 202mm (8")



**MOM Sickle Knife W/Suction**

Catalog #	Description
MCO1oMO	1.0mm O.D., 206mm (8")



**Morgon Sickle Knife**

Catalog #	Description
MCO1oM	4.0mm Blade, 165mm (6½")



**Plester Flap Knife**

Overall length 165mm (6½")

Catalog #	Description
MCO6	2.55 x 2.2mm, Straight
MCO6C	2.2 x 2.2mm, Angled

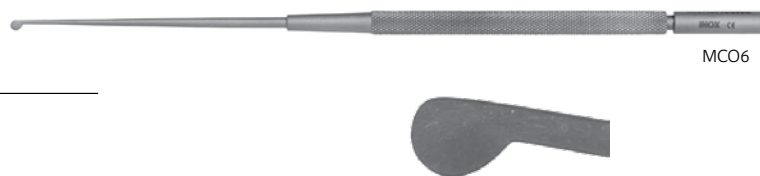

**Politzer Lancet Knife Handle and Blades**

Catalog #	Description
7725	Handle, Angled Tip, 85mm (3¾")
7725P1	No. 1, Blade, 1.6 x 3.0mm, 64mm (2½"), 3/PKG
7725P2	No. 2, Blade, 1.9 x 4.0mm, 64mm (2½"), 3/PKG
7725P3	No. 3, Blade, 2.15 x 4.0mm, 64mm (2½"), 3/PKG

### Rosen Sickle Knife

Catalog #	Description
MCO10B	4.0mm Blade, 165mm (6½")



### Sterkers Sickle Knife

Catalog #	Description
MCO301	7.2mm Blade, 180mm (7")



### LOOPS

#### Billeau Ear Loop

Catalog #	Description
7718	4.3 x 5.2mm Loop, 161mm (6¼")



#### Blunt Ear Loop

Catalog #	Description
7885A	4.2 x 14.5mm Loop, 200mm (7¾")



#### Snellen Ear Loop

Catalog #	Description
7885	4.5 x 19.5mm Loop, 142mm (5⅝")



#### Saint Paul Ear Loop

Overall length 90mm (3½")

Catalog #	Description
7886	3 x 4 mm Loop

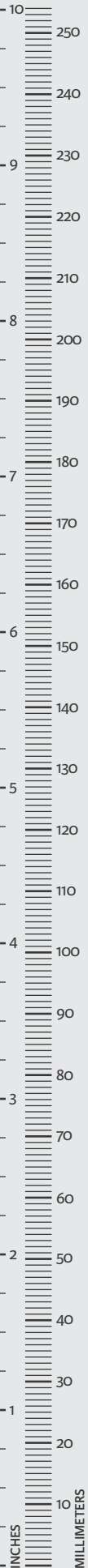

### Traumann Ear Loop

Catalog #	Description
7888	4.1 x 4.9mm Loop, 170mm (6¾")



## MEASURING RODS

### Measuring Rods

Overall length 165mm (6½"), Angled Shaft

Catalog #	Description
MCO12B	4.5, 5.0, 5.5mm Markings
MCO12H	3.5, 4.0, 4.5mm Markings



### Cause Measuring Rods

Overall length 165mm (6½"), Angled Shaft

Catalog #	Description
MCO12C	4.75, 5.0, 5.25mm Markings



### Charachon Measuring Rods

Catalog #	Description
MCO830	4.5, 5.0, 5.5mm Markings



### Dumon Measuring Rods

Overall length 165mm (6½"), Angled Shaft

Catalog #	Description
MCO12J	3.0, 3.5, 4.0mm Markings



### Robier Measuring Rods

Overall length 165mm (6½"), Malleable

Catalog #	Description
MCO12R	3.0, 4.0, 5.0mm Markings



**Sauvage Measuring Rod**

Overall length 170mm (6¾")

Catalog #	Description
MCO844	1.0, 2.0, 3.0mm Markings



**Vince Measuring Rod**

Overall length 170mm (6¾")

Catalog #	Description
MCO12E	4.75, 5.0, 5.25mm Markings



**Columella Distance Measuring Rod Forceps**

Working length 70mm (2¾")

Catalog #	Description
MCO34	Measures 0-6mm



**MIRRORS**

**Martin Knife/Mirror**

Catalog #	Description
MCO215	3.0 x 4.0mm, 165mm (6½")



**Zini Mirror**

Catalog #	Description
MCO216-3-5	3.5mm Diameter, 165mm (6½")



**PERFORATORS**

**Ear Perforator Burr**

Overall length 125mm (4 7/8")

Catalog #	Description
MCO29-1	0.6mm Tip
MCO29	0.8mm Tip



**Middle Ear Perforator**

Overall length 165mm (6 1/2")

Catalog #	Description
MCO218-4	0.4mm Tip
MCO218-6	0.6mm Tip
MCO218-8	0.8mm Tip



**PICKS**

**Blunt Pick**

Overall length 165mm (6 1/2")

Catalog #	Description
MCO801	0.4mm Tip, Angled 20°



**Bruzzo Pick**

Working length 85mm (3-3/8"), Bayonet

Catalog #	Description
MCO342	0.4mm, Straight, Blunt
MCO343	0.4mm, Curved, Blunt



**Charachon Pick**

Overall length 165mm (6 1/2")

Catalog #	Description
MCO800	0.2 x 14.0mm, Angled 20°

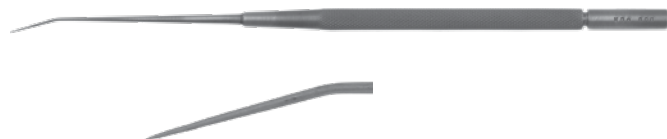

### Curved Pick W/Suction

Overall length 206mm(8")

Catalog #	Description
MCO221MO	1.0mm O.D. Suction Tip

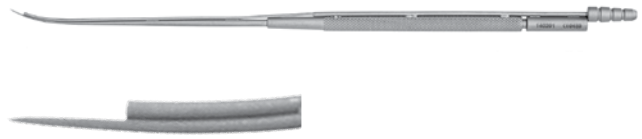

### Ear Picks

Overall length 165mm (6½")

Catalog #	Description
MCO221	0.35mm, Light Curve
MCO221A	0.4mm, Curved 40°
MCO31	0.3mm, Straight
MCO6A	0.75mm, Angled 45°
MCO6B	0.75mm, Angled 90°

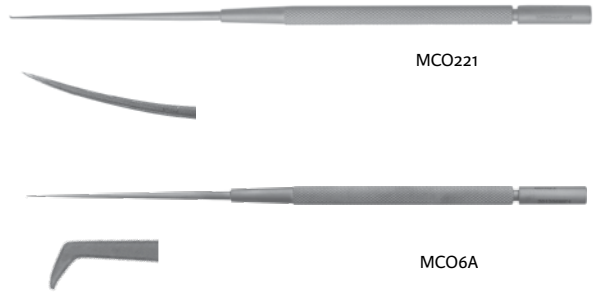

### Legent Monopolar Pick

Overall length 185mm (7¼")

Catalog #	Description
MCO989	Curved
CP391	Monopolar Cable, 185cm (6'8")



### Marquet Pick

Overall length 165mm (6½")

Catalog #	Description
MCO901	0.4mm, Angled Tip 20°



### Portmann Handle Pick

Overall length 77mm (3")

Catalog #	Description
MCO970	0.4mm, Straight Tip





**Marquet Ball Tip Probe**

Overall length 165mm (6½")

Catalog #	Description
MCO924	1.1mm Ball Tip, Curved



**Sterkers Ball Tip Probe**

Overall length 165mm (6½")

Catalog #	Description
MCO813	1.1mm Ball Tip, Straight



**Tenotome Probe**

Overall length 165mm (6½")

Catalog #	Description
MCO802	.085mm, Angled Tip 30°



**RASPS**

**Marquet Rasp**

Overall length 165mm (6½")

Catalog #	Description
MCO917	0.3mm, Anterior, Angled
MCO918	0.25mm, Posterior, Angled



**Stenstrom Rasp**

Overall length 161mm (6¼")

Catalog #	Description
CP85L	2.0 x 8.9mm, Angled Left
CP85R	2.0 x 8.9mm, Angled Right



**Angot-Vanecloo Retractor**

Overall length 132mm (5¼"), Self-Retaining

Catalog #	Description
MCO351	3-Prong Sharp, 13.3mm Wide Center Blade



**Bizeau Retractor**

Overall length 160mm (6¼"), Self-Retaining

Catalog #	Description
MCL359	20.0 x 31.5mm Solid Blades

**Mondain Retractor**

Overall length 139mm (5½"), Self-Retaining

Catalog #	Description
MCO358	53.0mm (2⅛") Spread

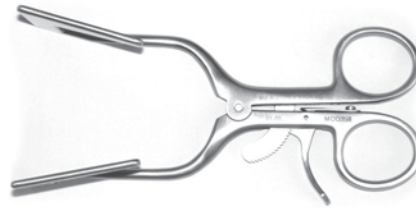

**Robier Retractor**

Overall length 181mm (7¼")  
Malleable Blade with Integrated Suction,  
Adjustable in Length, Height and Rotation

Catalog #	Description
MCO357A	Retractor with Malleable Integrated Suction Blades



**Beckman-Weitlaner Retractor**

Overall length 163mm (6½"), Hinged

Catalog #	Description
7781	3 x 4 Blunt Prongs



**Plester Retractor**

Overall length 110mm (4<sup>3</sup>/<sub>8</sub>" )

Catalog #	Description
o-28-3	2 Sharp Prongs, Right
o-28-4	2 Sharp Prongs, Left

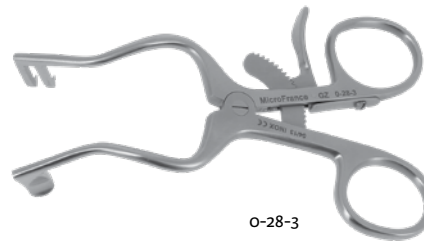

o-28-3

**Schucknecht Retractor**

Overall length 130mm (5<sup>1</sup>/<sub>8</sub>" )

Catalog #	Description
o-28-2*	3 x 3 Sharp Prongs

\*Not for sale in US

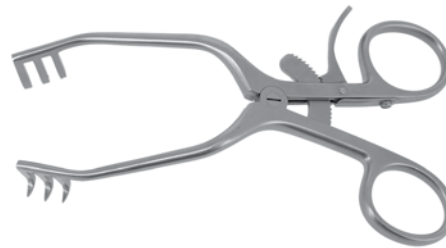

**Weitlaner Retractor (Baby)**

Overall length 110mm (4<sup>3</sup>/<sub>8</sub>" )

Catalog #	Description
o-28-8*	3 x 3 Sharp Prongs

\*Not for sale in US



**Weitlaner-Wullstein Retractor**

Overall length 131mm (5<sup>1</sup>/<sub>8</sub>" )

Catalog #	Description
o-28-1*	3 x 3 Sharp Prongs

\*Not for sale in US

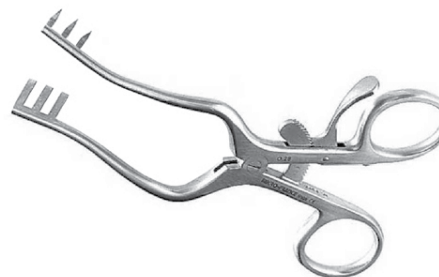

**Weitlaner Retractor**

Catalog #	Description
o-28*	3 x 4 Sharp Prongs, 130mm (5 <sup>1</sup> / <sub>8</sub> " )
o-28-7*	3 x 4 Sharp Prongs, 157mm (6 <sup>1</sup> / <sub>4</sub> " )

\*Not for sale in US

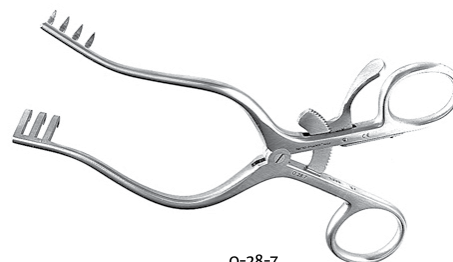

o-28-7

### Knife Handle

Catalog #	Description
CP821	Round Knurled Handle, 157mm (6¼")



### Beaver Knife Handle

Catalog #	Description
CP821B	Overall length 100mm (37⁄8")
CP821C	Overall length 130mm (51⁄8")
CP821D	Overall length 150mm (57⁄8")
CP821E	Overall length 170mm (63⁄4")



CP821C

### Swann-Morton Scalpel Handle

Overall length 120mm (4¾")

Catalog #	Description
1003IG*	Size 3, Graduated for Blades #11 & #15
1004IG*	Size 4, Graduated for Blades #23



1003IG

\*Not for sale in US

### Swann-Morton Scalpel Handle

Catalog #	Description
1005I*	Size 5, for Blades #11 & #15, 160mm (6¼")
1003LI*	Size 3L, for Blades #23, 200mm (7¾")



1005I

\*Not for sale in US

**Micro Scissors**

Working length 65mm (2½")

Catalog #	Description
MCO4	4.5mm Blades, Straight
MCO4A	3.0mm Blades, Straight
MCO4B	2.8mm Blades, Curved Right
MCO4C	2.8mm Blades, Curved Left
MCO4D	3.5mm Blades, Angled Right
MCO4E	3.5mm Blades, Angled Left
MCO4F	3.0mm Blades, Curved

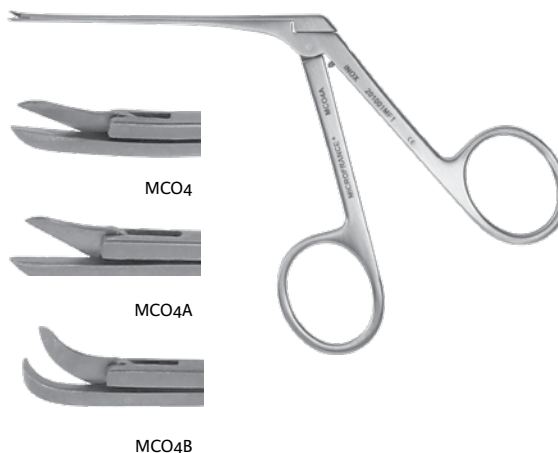

**Sterkers-Micro Scissors**

Catalog #	Description
MCO310	5.0mm, Straight, 98mm (3⅞")
MCO318	3.0mm, Curved Left, 96mm (3¾")
MCO319	3.0mm, Curved Right, 96mm (3¾")

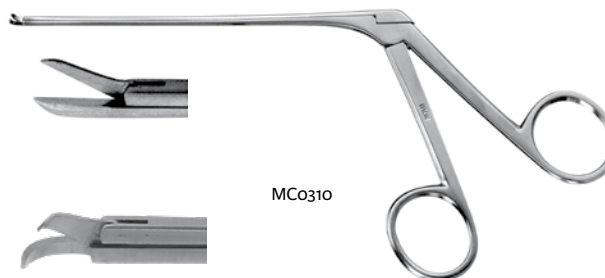

### Darrouzet Speculum

Overall length 42mm (1<sup>5</sup>/<sub>8</sub>" )

Catalog #	Description
MCO978S	3.1 x 29.0mm



### Deveze Speculum

Overall length 130mm (5<sup>1</sup>/<sub>8</sub>" )

Catalog #	Description
MCO981D	3.1 x 34.0mm

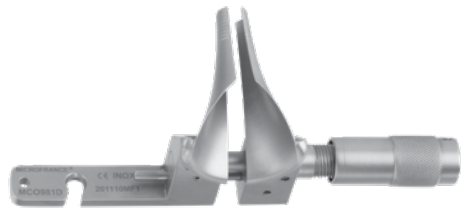

### Legent Diagnostic Ear Specula

Catalog #	Description
8812-1*	No. 1, 3.0mm
8812-2*	No. 2, 4.5mm
8812-3*	No. 3, 5.0mm
8812-4*	No. 4, 5.5mm
8812-5*	No. 5, 6.0mm

\*Not for sale in US



8812-3

### Legent Otoscope

Catalog #	Description
8820	Includes 5 Speculum, 8812-1 thru 8812-5

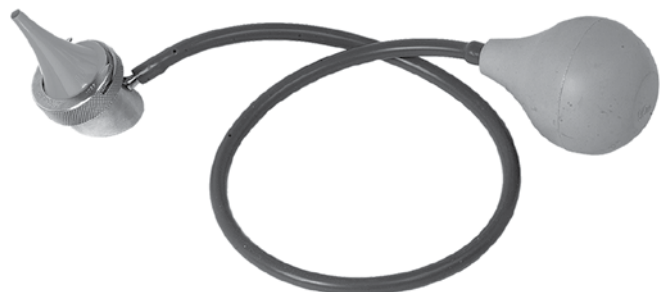

### Le Mee Diagnostic Ear Specula

Working length 65mm (2½")

Catalog #	Description
9913-1*	No. 1, 1.0mm
9913-2*	No. 2, 2.0mm
9913-3*	No. 3, 3.0mm
9913-4*	No. 4, 4.0mm
9913-5*	No. 5, 5.0mm
9913-6*	No. 6, 6.0mm
9912-7*	No. 7, 7.0mm
9912-8*	No. 8, 8.0mm
9912-9*	No. 9, 9.0mm



9913-4



9912-7

\*Not for sale in US

### Diagnostic Ear Specula, Disposable

Plastic, autoclavable

Catalog #	Description
8814T1*	No. 1, 3.0mm, 100/Pkg
8814T2*	No. 2, 4.5mm, 100/Pkg
8814T3*	No. 3, 5.0mm, 100/Pkg
8814T4*	No. 4, 5.5mm, 100/Pkg
8814T5*	No. 5, 6.0mm, 100/Pkg



8814T1

8814T2

8814T3

8814T4

8814T5

\*Not for sale in US

### Brackman Suction Irrigator

Working length 110mm (4 3/8")

Catalog #	Description
MCO352-20	2.0mm O.D., Angled 133°
MCO352-25	2.5mm O.D., Angled 133°
MCO352-30	3.0mm O.D., Angled 133°



MCO352-25

### Cause Suction Irrigator

Working length 90mm (3 1/2")

Catalog #	Description
MCO661-7	0.7mm O.D., Straight
MCO661-10	1.0mm O.D., Straight



MCO661-7

### Dubreuil Suction Tube

Working length 101mm (4")

Catalog #	Description
MCO353D10	2.1mm O.D., Straight



### Frayse Suction Tube W/Luer Lock

Working length 95mm (3 3/4")

Catalog #	Description
MCO366F10	1.0mm O.D., Angled 145°
MCO366F12	1.2mm O.D., Angled 145°
MCO366F15	1.5mm O.D., Angled 145°
MCO366F20	2.0mm O.D., Angled 145°

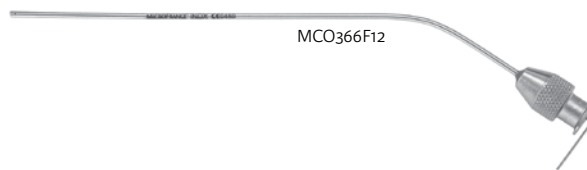

MCO366F12

Working length 115mm (4 1/2")

Catalog #	Description
MCO367F10	1.0mm O.D., Angled 140°
MCO367F12	1.2mm O.D., Angled 140°
MCO367F15	1.5mm O.D., Angled 145°
MCO367F20	2.0mm O.D., Angled 145°

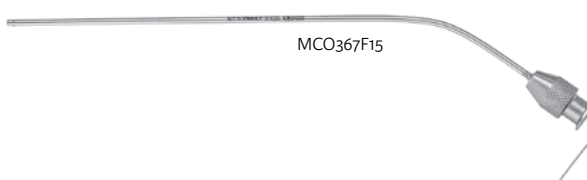

MCO367F15

Working length 140mm (5 1/2")

Catalog #	Description
MCO368F20	2.0mm O.D., Angled 140°
MCO368F25	2.5mm O.D., Angled 135°



MCO368F25



### Wertheimer Suction Tube

Working length 115mm (4½")

Catalog #	Description
MCO770-1-5	No. 1, 1.5mm O.D.
MCO770-2-0	No. 2, 2.0mm O.D.
MCO770-2-5	No. 3, 2.5mm O.D.
MCO770-3-0	No. 4, 3.0mm O.D.
MCO770-3-5	No. 5, 3.5mm O.D.
MCO770-4-0	No. 6, 4.0mm O.D.



### House Suction Adapter

Catalog #	Description
MCO776	2.5mm I.D., 52mm (2")

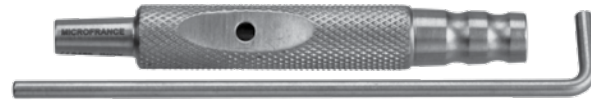

### Lempert Suction Tube

Working length 120mm (4¾")

Catalog #	Description
MCO771-2-5	2.5mm O.D., Angled 135°
MCO771-3-0	3.0mm O.D., Angled 135°
MCO771-4-0	4.0mm O.D., Angled 135°



### Maspetiol Suction Tube

Working length 58mm (2¼")

Catalog #	Description
MCO773	2.5mm O.D., Angled 156°



### Microsurgery Suction Tube

Working length 70mm (2¾")

Catalog #	Description
MCOP366A	1.2mm O.D., 70mm (2¾")
MCOP366B	1.2mm O.D., 100mm (3⅞")



### “Rosen-Type” Suction Cannula

Working length 85mm (3<sup>3</sup>/<sub>8</sub>" )

Catalog #	Description
MCO3Po5	0.5mm O.D., Angled 135°, 3/Pkg
MCO3Po7	0.7mm O.D., Angled 135°, 3/Pkg
MCO3P10	1.0mm O.D., Angled 135°, 3/Pkg
MCO3P12	1.2mm O.D., Angled 135°, 3/Pkg
MCO3P15	1.5mm O.D., Angled 135°, 3/Pkg
MCO3P18	1.8mm O.D., Angled 135°, 3/Pkg
MCO3P20	2.0mm O.D., Angled 135°, 3/Pkg
MCO3P24	2.4mm O.D., Angled 135°, 3/Pkg

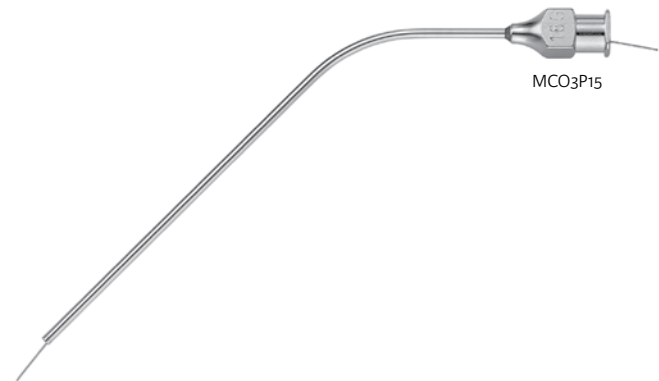

### Thomassin Suction Tube

Working length 76mm (3" )

Catalog #	Description
MCO3T-o-5	0.5mm O.D., Curved Tip, Angled 135°
MCO3T-o-7	0.7mm O.D., Curved Tip, Angled 135°
MCO3T-1-o	1.0mm O.D., Curved Tip, Angled 135°
MCO3T-1-2	1.2mm O.D., Curved Tip, Angled 135°

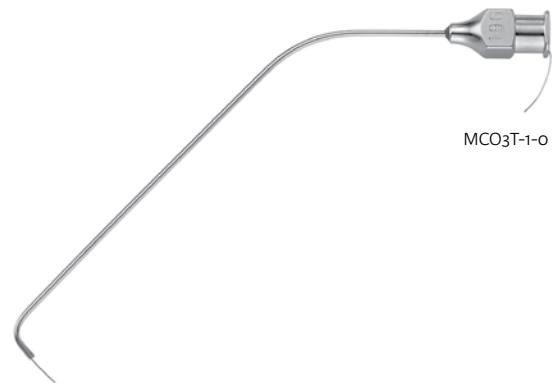

### Sterker Suction Irrigator

Working length 83mm (3<sup>1</sup>/<sub>4</sub>" )

Catalog #	Description
MCO306-20	2.0mm O.D., Angled 145°



### Maspetioli Suction Tube

Working length 40mm (1<sup>5</sup>/<sub>8</sub>" )

Catalog #	Description
MCO774-o-4	0.4mm O.D., Straight
MCO774-o-5	0.5mm O.D., Straight
MCO774-o-6	0.6mm O.D., Straight
MCO774D8	0.8mm O.D., Straight



### Suction Cannula

Working length 97mm (3<sup>7</sup>/<sub>8</sub>"

Catalog #	Description
MCO311-1-0	1.0mm O.D., Curved
MCO311-1-2	1.2mm O.D., Curved
MCO311-1-5	1.5mm O.D., Curved
MCO311-1-8	1.8mm O.D., Curved
MCO311-2-0	2.0mm O.D., Curved
MCO311-2-5	2.5mm O.D., Curved
MCO311-3-0	3.0mm O.D., Curved
MCO311-3-5	3.5mm O.D., Curved
MCO311-4-0	4.0mm O.D., Curved



MCO311-2-0

### Suction Irrigator

Working length 83mm (3<sup>1</sup>/<sub>4</sub>"

Catalog #	Description
MCO201-2-5	2.5mm O.D., Angled 145°
MCO201-3-0	3.0mm O.D., Angled 145°



MCO201-3-0

### Suction Irrigation Tube

Catalog #	Description
MCO352E20	2.0mm O.D., Angled 145°, 112mm (4 <sup>3</sup> / <sub>8</sub> "
MCO352E25	2.5mm O.D., Angled 145°, 112mm (4 <sup>3</sup> / <sub>8</sub> "
MCO352N20	2.0mm O.D., Angled 145°, 142mm (5 <sup>5</sup> / <sub>8</sub> "



MCO352E20

### Charachon Suction Tube W/Thumb Control

Working length 88mm (3½")

Catalog #	Description
MCO890	0.3mm O.D., Angled 130°



Working Length 46mm (1¾")

Catalog #	Description
MCO890-1-04	0.4mm O.D., Straight
MCO890-1-08	0.8mm O.D., Straight
MCO890-1-10	1.0mm O.D., Straight
MCO890-1-12	1.2mm O.D., Straight
MCO890-1-15	1.5mm O.D., Straight
MCO890-1-20	2.0mm O.D., Straight



MCO890-1-12

### House Suction Tube

Blunt Eyes with Finger Control

Working length 115mm (4½")

Catalog #	Description
MCO770L15	1.5mm O.D., Angled 130°
MCO770L20	2.0mm O.D., Angled 130°
MCO770L25	2.5mm O.D., Angled 130°
MCO770L30	3.0mm O.D., Angled 130°
MCO770L35	3.5mm O.D., Angled 130°
MCO770L40	4.0mm O.D., Angled 130°



MCO770L20

### Suction Tube Handle

Working length 83mm (3¼")

Catalog #	Description
MCO1	4.0mm O.D., 115mm (4½")
MCO1B	4.0mm O.D., 123mm (4⅞")



MCO1B

### Suction Tube with Finger Control

Working length 110mm (4⅜")

Catalog #	Description
CP330-3-0	3.0mm (9FR.)
CP330-4-0	4.0mm (12FR.)



CP330-4-0

**Zimmermann Suction Tube W/Luer Lock**

Working length 98mm (3<sup>7</sup>/<sub>8</sub>" )

Catalog #	Description
MCO354	2.1mm O.D., Angled 153°



**Luer-Lock Adapter**

Overall Length 29mm (1<sup>1</sup>/<sub>8</sub>" )

Catalog #	Description
MCO775-1	2.7mm Inside Diameter



**Turning Adapter Luer Lock**

Overall Length 52mm (2" )

Catalog #	Description
MCO772	2.5mm Inside Diameter



### Charachon Ear Forceps Tray

Catalog #	Description
MCO862	10cm L x 4cm W x 6cm D, (3 <sup>7</sup> / <sub>8</sub> " L x 1 <sup>5</sup> / <sub>8</sub> " W x 2 <sup>3</sup> / <sub>8</sub> " D)

### Stainless Steel Tray

Catalog #	Description
MCO821-1	24.6cm L x 14.7cm W x 5.5cm D, (9 <sup>5</sup> / <sub>8</sub> " L x 5 <sup>3</sup> / <sub>4</sub> " W x 2 <sup>1</sup> / <sub>8</sub> " D)

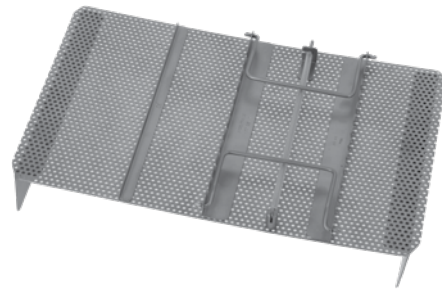

### Otology Instrument Tray

Catalog #	Description
MCO824-1	Stainless Steel, 33.5cm L x 19.5cm W x 6.9cm D, (13 <sup>1</sup> / <sub>4</sub> " L x 7 <sup>3</sup> / <sub>4</sub> " W x 2 <sup>3</sup> / <sub>4</sub> " D)

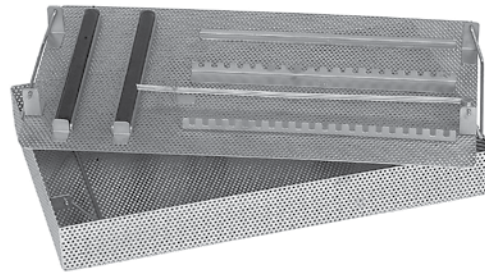

### Instrument Holder Insert

Catalog #	Description
MCO865-1	Stainless Steel, 21cm L x 9.7cm W x 3.2cm D, (8 <sup>1</sup> / <sub>4</sub> " L x 3 <sup>7</sup> / <sub>8</sub> " W x 1 <sup>1</sup> / <sub>4</sub> " D)



### Thomassin Tray Insert

Catalog #	Description
MCO866	Stainless Steel, 21.7cm L x 9.7cm W x 3.7cm D, (8 <sup>1</sup> / <sub>2</sub> " L x 3 <sup>7</sup> / <sub>8</sub> " W x 1 <sup>1</sup> / <sub>2</sub> " D)

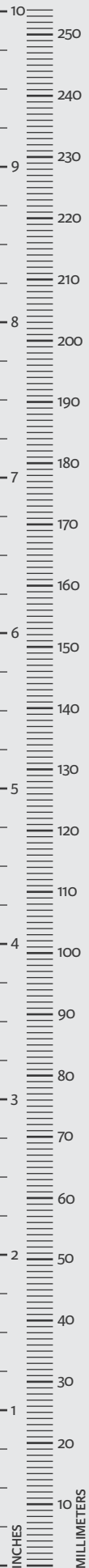
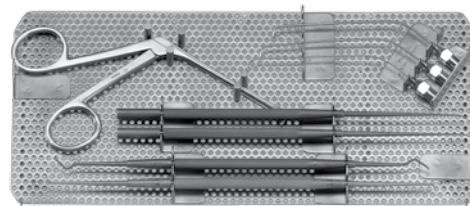

### Darrouzet Suction Pump Foot Switch

Catalog #	Description
MCO551*	Port # 1 - 0.6mm I.D. Port # 2 - 4.5mm I.D. Port # 3 - 6.2mm I.D.

\*Not for sale in US

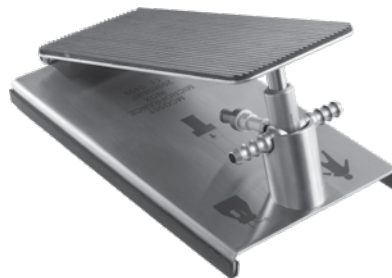

### Darrouzet Suction Pump Trumpet Valve

Catalog #	Description
MCO551A*	3.3mm I.D., 4.4mm O.D.

\*Not for sale in US



### Darrouzet Suction Irrigation Adapter

Catalog #	Description
MCO551B*	4.5mm I.D., 8.5mm O.D.

\*Not for sale in US



### Fascia Press

Overall length 80mm (3 1/8")

Catalog #	Description
MCO819	29.0mm x 50.0mm



### Footprint Press

29.0mm x 50.0mm, 3 Footprints

Catalog #	Description
MCOP820	No. 1, 7.0mm, No. 2, 9.0mm, No. 3, 15.0mm



### MOM Ball End Seeker, W/Suction

Overall length 206mm (8")

Catalog #	Description
MCO330MO	1.0mm O.D. Suction, 1.5 x 3.9mm Ball Tip



### Flexible Arm Retractor

Working length 245mm (9¾")

Catalog #	Description
MCO978	16.0mm O.D.



### Legent Flexible Tension Arm

Catalog #	Description
MCO980	Flexible Tension Arm 450mm (17¾")
MCO981	Ear Speculum Forceps
MCO982	Nasal Speculum Connection
MCO983	Malleable Blade Retractor, 12.0 x 86.0mm

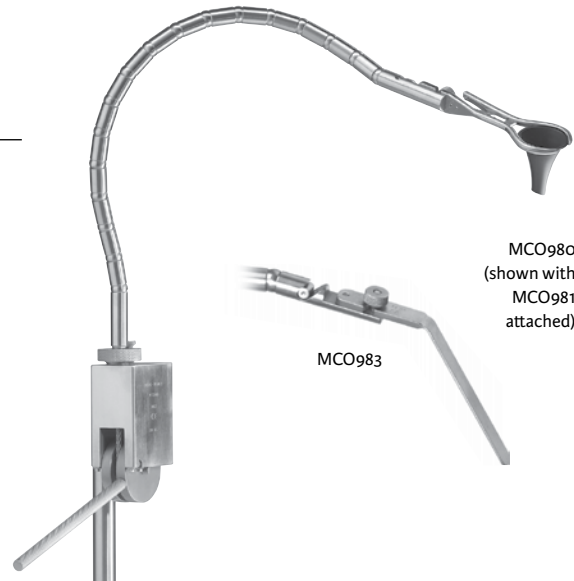

MCO980  
(shown with  
MCO981  
attached)

MCO983

### Legent Flexible Tension Arm Accessories

Catalog #	Description
CEV980-3	Endoscope Holder (Fits Rigid Telescopes 4-10mm)
MCO983-4	Angulated Ball Joint for MCO980
CEV984	Operating Table Clamp
MCO981D	Devéze Self-Retaining Speculum

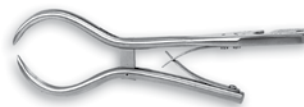

MCO981



MCO982



CEV980-3

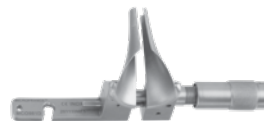

MCO981D



MCO983-4



CEV984



### Legent T-Tube Inserter

Catalog #	Description
MCO997	1.5mm Wide, 165mm (6½")



### Schuknecht Wire Bending Die

Catalog #	Description
MCO985	Working length 12.3mm

### Temporal Bone Specimen Holder

Catalog #	Description
MCO823	6½" W x 4" D



### Vent Tube Cutting Block

Overall length 118mm (4⅝"), 12.0mm Wide

Catalog #	Description
MCO213-4	0.5 and 0.7mm Hole Diameter, Step Height 0.25mm
MCO213-6	0.6 and 0.8mm Hole Diameter, Step Height 0.25mm



MCO213-4

### Vincent Punch

Designed for silastic banding stabilization technique using the Silverstein Silicone Implant (1128305)

Catalog #	Description
MCO571	0.8mm, Working Length 34mm (1⅜")





**INTEGRA**<sup>®</sup>  
LIMIT UNCERTAINTY



# Integra<sup>®</sup> MicroFrance<sup>®</sup>

## Plastic Surgery Instrumentation

### Rhinoplasty Instrument Set

The guard and tip of the osteotome is specially shaped to glide along the lateral surface of the bone during lateral osteotomy. The curved rasp's small cutting surface helps with targeted reduction of the dorsal hump and radix. The suction elevators help provide visibility during septoplasty.

Catalog #	Description
3717008**	Rhinoplasty Instrument Set

Set consist of the following;

Catalog #	Description
CP1100	Curved Rasp, 100mm (3 <sup>7</sup> / <sub>8</sub> " )
CP1102	Suction Elevator, Sharp, 82mm (3 <sup>1</sup> / <sub>4</sub> " )
CP1103	Suction Elevator, Blunt, 82mm (3 <sup>1</sup> / <sub>4</sub> " )
CP1109	Cartilage Template, Black Delrin, 80 x 90mm 1 x 1cm Gridlines, Templates, 6.87, 7.65 and 10.3mm
CP604BR	Adson Bipolar Forceps, 120mm (4 <sup>3</sup> / <sub>4</sub> " )
CP313-1	Becker Osteotome, Guarded, 3.0mm, 200mm (7 <sup>3</sup> / <sub>4</sub> " )
3714038	Freer Septum Elevator, Double-Ended, 4.5, 180mm (7" )
3714125	Joseph Periosteal Elevator, 5.0mm, 170mm (6 <sup>3</sup> / <sub>4</sub> " )
3714127	Cottle Septum Elevator, Graduated, Double-Ended, 217mm (8 <sup>1</sup> / <sub>2</sub> " )
3711002	Lucae Ear Forceps, Delicate, Bayonet, 146mm (5 <sup>3</sup> / <sub>4</sub> " )
3711021	Takahashi Nasal Forceps, 4.0 x 9.0mm, 115mm (4 <sup>1</sup> / <sub>2</sub> " )
3740039	Brown-Adson Tissue Forceps, 7 x 7 Teeth, 121mm (4 <sup>3</sup> / <sub>4</sub> " ) 2/EA.
3740028	Adson Tissue Forceps, Delicate, 2 x 3 Teeth, 120mm (4 <sup>3</sup> / <sub>4</sub> " )
3740051	Bishop-Harmon Tissue Forceps, 0.3mm, 1 x 2 Teeth, 86mm (3 <sup>3</sup> / <sub>8</sub> " )
3740053	Bishop-Harmon Tissue Forceps, Curved, 1 x 2 Teeth, 86mm (3 <sup>3</sup> / <sub>8</sub> " )
3755101	Halstead Mosquito Forceps, Straight, 120mm (4 <sup>3</sup> / <sub>4</sub> " )
3755102	Halstead Mosquito Forceps, Curved, 125mm (4 <sup>7</sup> / <sub>8</sub> " )
3714045	Double Fixation Hook, 3.0mm, 122mm (4 <sup>3</sup> / <sub>4</sub> " )
3714021	Joseph Skin Hook, 2-Prong, 5.0mm, 159mm (6 <sup>1</sup> / <sub>4</sub> " )
3714023	Joseph Skin Hook, 2-Prong, 10.0mm, 159mm (6 <sup>1</sup> / <sub>4</sub> " )
3714110	Cottle-Joseph Double Hook, 2-Prong, 12.0mm, 137mm (5 <sup>3</sup> / <sub>8</sub> " )

\*\*Not for sale outside US

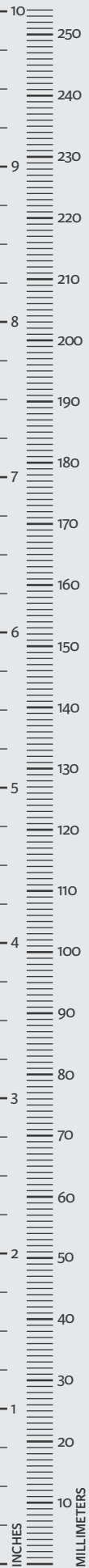

Rhinoplasty Instrument Set (continued)

Catalog #	Description
3714020	Joseph Skin Hook, 2-Prong, 2.0mm, 159mm (6¼")
3714179	Converse Nasal Retractor, 110mm (4¾")
3714681	Neivert Knife Guide and Retractor, Double-Ended 200mm (7¾")
3744012	Webster Needle Holder, Smooth, 130mm (5⅞")
3714059	Hexagonal Handle Osteotome, 2.0mm, 159mm (6¼")
3714076	Rubin Osteotome, Finger Grip, 14mm
3714077	Rubin Osteotome, Finger Grip, 16mm
3714060	Hexagonal Handle Osteotome, 3.0mm, 159mm (6¼")
3740086	Ruler 6", Stainless Steel, Millimeters and Inches
3752008	Castroviejo Needle Holder, Delicate, Straight w/Lock, 10.0mm, 140mm (5½")
3714148	Fomon Rasp, Fine, Double-Ended, 210mm (8¼")
3714149	Fomon Rasp, Coarse, Double-Ended, 210mm (8¼")
3714063	Hexagonal Handle Osteotome, 5.0mm, 159mm (6¼")
3713005	Iris Scissors, Curved, Lower Blade Serrated, 105mm (4⅛")
3713013	Stevens Tenotomy Scissors, Standard, Straight, 112mm (4¾")
3713014	Stevens Tenotomy Scissors, Standard, Curved, 110mm (4¾")
3741033	Stitch Scissors, Ribbon Type, Curved, 98mm (3⅞")
3741076	Metzenbaum Scissors, Delicate, Curved, 133mm (5¼")
3741164	Wilmer Conjunctival Scissors, Angled, Sharp, 93mm (3⅝")
3714201	Vienna Nasal Speculum, Size 3, 30mm Blades
3714472	Cottle Septum Speculum, 50.0mm Blades, 135mm (5⅜")
3714206	Killian Septum Speculum, 65mm Blades
3714004	Frazier Suction Tube, 10FR. Angled, 100mm (3⅞")
3714001	Frazier Suction Tube, 7FR. Angled, 100mm (3⅞")
3714353	Cottle Mallet, 7 OZ., 185mm (7¼"), 1 Nylon/1Stainless Head
3750012	Cartilage Crusher, 65mm (2½")
3717011	Rhinoplasty Tray, 3-Level, 52.8cm L x 25cm W x 12.3cm D (20¾" L x 9¾" W x 4⅞" D)

\*\*Not for sale outside US



3714020



3714179



3714681



3744012



3714059



3714076



3740086



3752008



3714149



3714472



3714201



3713013



3714201



3714004



3714353

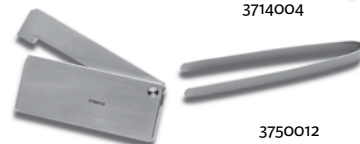

3750012

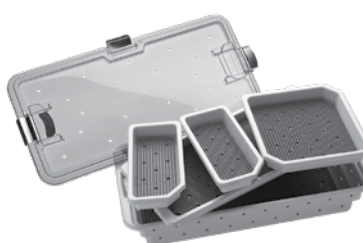

3717011

### Becker Rhinoplasty Instruments

The converse scissors are specially shaped and can be used for sharp incisions and blunt dissection in a number of rhinoplasty applications. The 2.5mm and 3.0mm single-guarded osteotomes have been designed to perform lateral osteotomy. The diamond-coated jaws of the diamond-jaw needle holder allow a secure grip on needles and suture.

Developed in conjunction with Daniel G. Becker, MD

Catalog #	Description
CP313	Osteotome, Guarded, 2.5mm, 200mm (7¾")
CP313-1	Osteotome, Guarded, 3.0mm, 200mm (7¾")
CP1104	Rasp, Double-Ended, Grits 1 & 2, 211mm (8¼")
CP1105	Rasp, Double-Ended, Grits 3 & 4, 211mm (8¼")
CP1106	Becker Converse Scissors, Serrated, 90mm (3½")
CP1107	Needle Holder, Tungsten-Carbide, 131mm (5⅛")



CP313



CP313-1



CP1104



CP1105



CP1106



CP1107





## CHISELS

### Cottle Chisel

Overall length 195mm (7¾")

Catalog #	Description
CP806	6.0mm, Curved
CP808-6	6.0mm, Curved, 10.0mm Depth Markings



CP806



CP808-6

### Double Guarded Chisel

Catalog #	Description
CP807	4.3mm, 196mm (7¾")



### Jost Chisel

Overall length 185mm (7¼")

Catalog #	Description
CP801-7	7.0mm, Straight
CP801-10	10.0mm, Straight
CP802	4.0mm, Straight, Guarded



CP801-7

### “V” Shaped Chisel

Overall length 183mm (7¼")

Catalog #	Description
CP908	3.0mm, Straight



## CURETTES

### Volkman

Overall length 170mm (6¾")

Catalog #	Description
CP302-4	Size 000, 4.0mm
CP302-5	Size 00, 5.0mm
CP302-6	Size 0, 6.0mm
CP302-8	Size 2, 9.0mm



CP302-6

### Agris-Dingmann Elevator/Dissector

Overall length 375mm (14¾")

Catalog #	Description
CP991L	7.4 x 195.0mm, Curved Left
CP991R	7.4 x 195.0mm, Curved Right



### Elevator/Dissector

Catalog #	Description
CP985	4.8 x 35.0mm, 184mm (7¼")



### Lempert Raspatory

Catalog #	Description
CP946	6.9 x 34.0mm, 184mm (7¼")

### Plastic Surgery Elevator

Catalog #	Description
M815A	4.2 x 32.0mm, 150mm (5⅞")
M815B	3.0 x 32.0mm, 150mm (5⅞")



### Plastic Surgery Elevator

Overall length 165mm (6½")

Catalog #	Description
CP944	8.5 x 35.0mm, Double Tooth

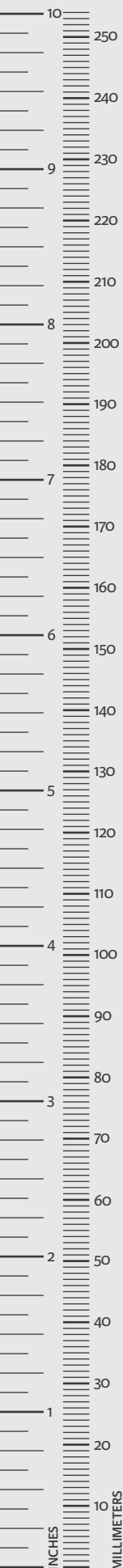



### Sebileau Elevator

Catalog #	Description
CP825	4.5mm, 153mm (6")



### Slamia Breast Elevator

Catalog #	Description
CP845	36.5mm, 314mm (12 1/4")



### Stenstrom Elevators

Catalog #	Description
CP85AL	1.9 x 9.5mm, Left, 161mm (6 1/4")
CP85AR	1.9 x 9.5mm, Right, 161mm (6 1/4")



CP85AR

### Trelat Elevators

Catalog #	Description
CP958	4.6 x 20.0mm, Curved, 172mm (6 3/4")
CP959	3.0 x 20.0mm, Curved, 172mm (6 3/4")
CP960	3.6 x 31.0mm, Curved, 150mm (5 7/8")

### D'Assumpcao Flap Forceps

Catalog #	Description
CP829T	4.5mm, 145mm (5¾")



### Pitanguy Small Flap Demarcator

Catalog #	Description
CP830	5.0mm, 155mm (6")



### Micro Dissecting Forceps

Overall length 135mm (5⅜")

Catalog #	Description
MCM4BISR	1 x 2 Teeth with Platform
MCM4R	0.3 x 8.0mm, Smooth with Platform



MCM4R

### Forceps W/Teeth

Catalog #	Description
CP640	Overall length 131mm (5⅛")



### Servant Desepidermiser Pince Forceps

Catalog #	Description
CP994	Overall length 139mm (5½")

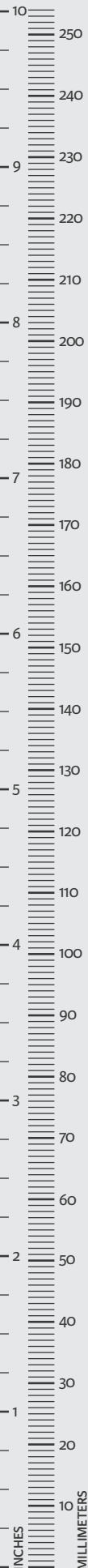

**FORCEPS**

---

**Bipolar Jewelers Forceps**

Overall length 113mm (4½")

Catalog #	Description
MCM6BIS	.05 x 3.0mm Tip, Straight, Insulated

**Jewelers Forceps**

Overall length 130mm (5¼")

Catalog #	Description
MCM973D3	No. 3, Very Fine
MCM973D5	No. 5, Very Fine



**Jewelers Forceps**

Overall length 135mm (5⅜"), Round Handle

Catalog #	Description
MCP5R-5	.04mm Tip, Straight

**GOUGES**

---

**Killian Septum Gouge**

Catalog #	Description
CP823-5	5.5mm, Bayonet, 151mm (6")



**“V”Shaped Gouge**

Catalog #	Description
CP824-5	5.5mm, Bayonet, 151mm (6")



### Ginestet Bone Hook

Catalog #	Description
CP986	28.0mm, 262mm (10 <sup>1</sup> / <sub>4</sub> "



### Round Cartilage Hook

Catalog #	Description
CP628	6.5mm, 145mm (5 <sup>3</sup> / <sub>4</sub> "



### Humby Double Hook

Catalog #	Description
CP941	4.2mm, 113mm (4 <sup>1</sup> / <sub>2</sub> "



### Large Tendon Hook

Catalog #	Description
M809	11.4 x 13.0mm, Blunt, 190mm (7 <sup>1</sup> / <sub>2</sub> "

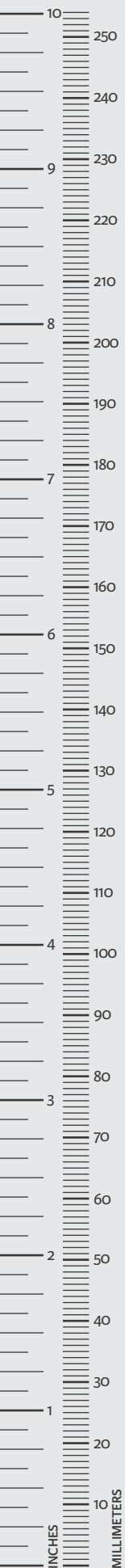

**KNIVES**

---

**Joseph Button End Knife**

Overall length 160mm (6¼")

Catalog #	Description
CP333	11.4mm Blade, Angled



**MALLETS**

---

**Mallet**

Overall length 180mm (7")

Catalog #	Description
CP300	Two Flat Faces, 25.0mm Diameter Head
CP907	25.0mm Diameter, One Nylon Cap



CP300

**Lombard Mallet**

Catalog #	Description
7766	28.0 x 28.0mm Head, 185mm (7¼")



**Square Head Mallet**

Overall length 164.0mm (6½")

Catalog #	Description
MCO995	15.1 x 15.1 x 30.0mm Head

### Aiach Osteotome

Catalog #	Description
CP317	16.0mm Wide, 159mm (6¼")



### Becker Osteotome

Overall length 200mm (7¾")

Catalog #	Description
CP313	2.5mm, Guarded
CP313-1	3.0mm, Guarded



CP313

### Claoue Osteotome

Overall length 185mm (7¼")

Catalog #	Description
CP305	3.0mm, Straight, Guarded
CP305L	3.0mm, Left, Guarded
CP305R	3.0mm, Right, Guarded



CP305

### Kawamoto Osteotome

Overall length 175mm (7")

Catalog #	Description
CP324	10.0mm, Curved

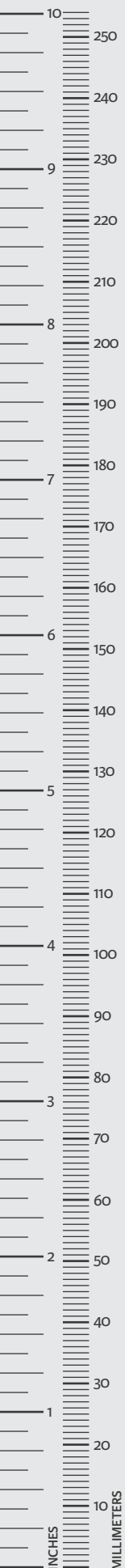

### Marchac Osteotome

Overall length 185mm (7¼")

Catalog #	Description
CP304-2	2.0mm, Straight
CP304-3	3.0mm, Straight
CP304-4	4.0mm, Straight
CP304-5	5.0mm, Straight
CP304-6	6.0mm, Straight
CP304-8	8.0mm, Straight
CP304-9	9.0mm, Straight
CP304-10	10.0mm, Straight
CP304-12	12.0mm, Straight
CP304-14	14.0mm, Straight
CP304-15	15.0mm, Straight
CP304-16	16.0mm, Straight



CP304-8

### Marchac Osteotome

Overall length 185mm (7¼")

Catalog #	Description
CP304B-2	2.0mm, Curved
CP304B-3	3.0mm, Curved
CP304B-4	4.0mm, Curved
CP304B-5	5.0mm, Curved
CP304B-6	6.0mm, Curved
CP304B-8	8.0mm, Curved
CP304B-10	10.0mm, Curved
CP304B-12	12.0mm, Curved



CP304B-4

### Marchac Osteotome

Overall length 185mm (7¼")

Catalog #	Description
CP315	4.5mm, Straight, Guarded
CP315D	4.5mm, Right, Guarded
CP315G	4.5mm, Left, Guarded



CP315

### McIndoe Osteotome

Overall Length 185mm (7¼")

Catalog #	Description
CP314-14	14.0mm, Gouge Type Blade

### Pellegrini Osteotome

Overall length 173mm (6¾")

Catalog #	Description
CP322	4.0mm, Straight, Guarded

### Pollet Pech Osteotome

Catalog #	Description
CP318	13.0mm, 161mm (6¼")



### Robin Osteotome

Overall length 160mm (6¼")

Catalog #	Description
CP309-8-12	8.0 x 12.0mm, Guarded
CP309-10-14	10.0 x 14.0mm, Guarded
CP309-12-16	12.0 x 16.0mm, Guarded
CP309-14-16	14.0 x 16.0mm, Guarded
CP309-14-18	14.0 x 18.0mm, Guarded



### Silver Osteotome

Overall length 183mm (7¼")

Catalog #	Description
CP901	3.5mm, Straight, Guarded
CP902	3.5mm, Curved Right, Guarded
CP903	3.5mm, Curved Left, Guarded

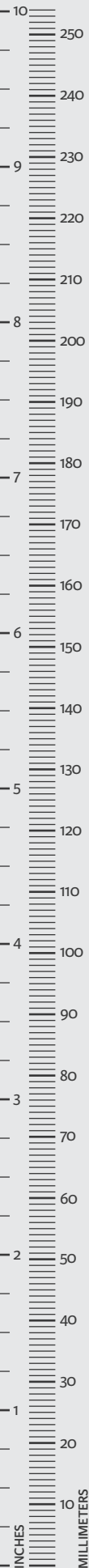



### Aufricht Rasps

Catalog #	Description
CP973	8.8 x 24.0mm, Cuts Down, 205mm (8")
CP974	8.8 x 24.0mm, Cuts Up, 205mm (8")
CP976	8.6 x 30.0mm, Cross-Cut, 198mm (7¾")



CP973

### Belloc Rasps

Overall length 193mm (7½")

Catalog #	Description
CP975	3.8 x 14.0mm, Coarse, Curved Left or Right
CP975A	3.8 x 15.0mm, Fine, Curved Left or Right



CP975

### Bigot Rasps

Catalog #	Description
CP998	12.0 x 5.6mm, Cuts Down, 190mm (7½")
CP998-1	12.0 x 8.0mm, Cuts Down, 190mm (7½")



CP998-1

### Defourmentel, Rasp

Overall length 208mm (8¼"), Double-Ended

Catalog #	Description
CP301-8	7.0 x 11.8mm - 7.4 x 29.9mm

### Diamond Dust Rasps, Single-Ended

Overall Length 181mm (7¼")

Catalog #	Description
CP809	8.0mm, Curved
CP810	8.0mm, Straight



CP809



CP810

### Fomon Rasp, Single-Ended

Catalog #	Description
CP301-2	8.7 x 31.0mm, Cuts Down, 179mm (7")



### Curved Rasp

Overall length 175mm (7")

Catalog #	Description
CP301-3	7.7 x 20.8mm, Cuts Down

### Fomon Rasp, Double-Ended

Overall length 211mm (8¼")

Catalog #	Description
CP301-4	Fine and Coarse, Cuts Down
CP301-6	Improved, Forward and Reverse Cutting



CP301-4

### Gorney Rasp, Double-Ended

Overall length 202mm (8"), Double-Ended

Catalog #	Description
CP301-9	8.6 x 22.0mm - 6.8 x 11.8mm



### Maltz Rasps, Single-Ended

Catalog #	Description
CP301	9.8 x 46.0mm, Cuts Down, 189mm (7½")
CP301-1	7.7x 35.0mm, Cuts Down, 169mm (6¾")
CP978	7.8 x 35.3mm, Cross-Cut, 177mm (7")



CP301

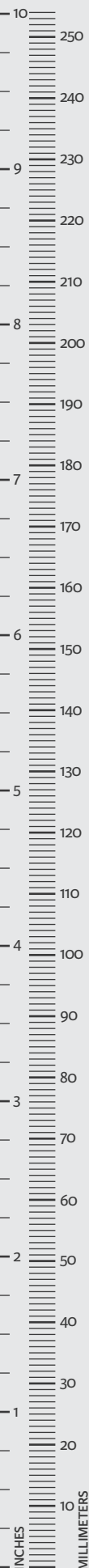

### Nasal Rasps, Single-Ended

Catalog #	Description
CP905	7.9 x 37.5mm, Cuts Down, 170mm (6¾")
CP828	8.0 x 35.3mm, Cross-Serrated, 168mm (6½")
CP827	9.8 x 46.7mm, Cross-Serrated, 190mm (7½")

### Nasal Rasp, Tungsten-Carbide

Overall length 212mm (8¼"), Double-Ended

Catalog #	Description
CP301-10	7.2 x 35.0mm, No. 3 & 4 Grit



### Parkes Rasp, Single-Ended

Catalog #	Description
CP904	9.1 x 36.7mm, Coarse, Concave, 207mm (8¼")

### Pech-Cannoni Rasp, Single-Ended

Catalog #	Description
CP905-1	7.0 x 37.1mm, Cuts Down, 170mm (6¾")

### Rasp, Cross-Cut, Single-Ended

Catalog #	Description
CP291	3.8 x 14.6mm, Curved, 202mm (8")



### Rees Rasps, Double-Ended

Overall length 212mm (8 1/4"), Double-Ended

Catalog #	Description
CP301-5	Fine and Coarse, Cuts on Down Stroke



### Veau Rasps, Single-Ended

Overall length 166mm (6 1/2")

Catalog #	Description
CP956	1.9 x 7.2mm, Angled
CP957	1.0 x 5.8mm, Angled

## RASPATORIES

### Farabeuf Raspatory

Catalog #	Description
7787-10	10.0mm, 153mm (6")

**Aufricht Nasal Retractor**

Overall length 165mm (6½")

Catalog #	Description
CP306	9.6mm Blade

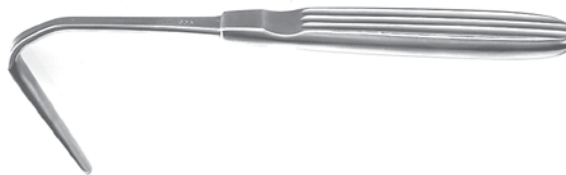

**Claoue Retractor**

Overall length 82mm (3¼"), Double-Ended

Catalog #	Description
CP340	12.0 and 15.0mm Wide Double Prongs



**Converse Alar Retractor**

Overall length 108mm (4¼"), Double-Ended

Catalog #	Description
CP341	11.5 and 14.5mm Wide Double Prongs



**Desmarres Retractor**

Overall length 137mm (5¾")

Catalog #	Description
CP822-10	10.0mm
CP822-12	12.0mm
CP822-14	14.0mm



CP822-12

**Dufourmental Retractor**

Overall length 174mm (6¾")

Catalog #	Description
CP947	9.0mm, 2-Prong



### Freeman Face Lift Retractor

Overall length 182mm (7¼")

Catalog #	Description
CP826	36.0mm, 4 Sharp Offset Prongs
CP826-1	20.0mm, 4 Sharp Offset Prongs



CP826

### Freeman Flap Retractor

Catalog #	Description
CP819-12	12.0mm, 192mm (7½")
CP819-15	15.0mm, 192mm (7½")



CP819-15

### Gorney Rake Retractor

Catalog #	Description
CP996	36.9mm, 4 Sharp Offset Prongs

### Joseph Retractor, (Skin Hook)

Overall length 159mm (6¼")

Catalog #	Description
CP23-4	5.0mm, Sharp Prongs
CP23-6	6.0mm, Sharp Prongs
CP23-8	9.4mm, Sharp Prongs
CP23-10	11.4mm, Sharp Prongs
CP23A-8	10.5mm, Blunt Prongs, W/Cross Bar



CP23-6



CP23A-8

### Jost Retractor

Overall length 129mm (5 1/8"), Double-Ended

Catalog #	Description
CP803	35.0mm Spatula - 6.5mm Wide Double Prongs



### Kilner Retractor

Overall length 93mm (3 5/8")

Catalog #	Description
CP331	12.3mm, Sharp Tips
CP331-1	10.8mm, Sharp Tips



CP331

### Loop and Ball End Retractor

Overall length 223mm (8 3/4")

Catalog #	Description
CP630	9.0mm Ball End - 12.3mm Loop End



### "Z" Type Retractor

Double-Ended, Overall length 118mm (4 5/8")

Catalog #	Description
CP338	9.9mm Wide, Double Right-Angle



CP338

### Right Angled Double Retractor

Double-Ended, Overall length 126mm (5")

Catalog #	Description
CP339	9.8mm Wide, Double Right-Angle

### Pessey Claw Retractor

Overall length 185mm (7 1/4")

Catalog #	Description
CP335	2.0mm Wide, 2-Prongs
CP335P	3.5mm Wide, 2-Prongs



CP335



CP335P

### Ragnell Retractor

Overall length 145mm (5¾"), Double-Ended

Catalog #	Description
CP632*	5.7 x 18.0mm - 4.5 x 11.5mm

\*Not for sale in US



### Rake Retractor

Overall length 147mm (5¾")

Catalog #	Description
CP21-3	5.5mm, 3-Prong Sharp
CP21A-3	5.5mm, 3-Prong Blunt



### Senn-Miller Retractor

Overall length 162mm (6½"), Double-Ended

Catalog #	Description
CP609	7.1mm x 20.0mm - 9.7 x 8.5mm Claw



### Volkman Retractor

Catalog #	Description
7782-1-2	6.0mm, 2-Prong Sharp, 153mm (6")





**RONGEURS**

**Beyer Bone Rongeur**

Catalog #	Description
CP380	3.5mm, Straight, 150mm (5 <sup>7</sup> / <sub>8</sub> " )
CP380-2	3.5mm, Curved, 150mm (5 <sup>7</sup> / <sub>8</sub> " )
CP380-1	2.0mm, Straight, 180mm (7" )
CP380-3	2.0mm, Curved, 180mm (7" )
CP380-5	3.5mm, Curved, 177mm (7" )



CP380

**SCISSORS**

**Becker Converse Scissors**

Overall length 93mm (3<sup>5</sup>/<sub>8</sub>" )

Catalog #	Description
CP1106	14.0mm, Serrated Blades



**Becker Wire Scissors, Tungsten Carbide**

Overall length 120mm (4<sup>3</sup>/<sub>4</sub>" )

Catalog #	Description
713T	Angled, One Blade Serrated



**Boettcher Scissors**

Catalog #	Description
CP997	Curved, 188mm (7 <sup>1</sup> / <sub>2</sub> " )



**Bregeat Scissors**

Catalog #	Description
CP363	Straight, 106mm (4 <sup>1</sup> / <sub>8</sub> " )



### Brophy Gum and Suture Scissors

Overall length 146mm (5¾")

Catalog #	Description
CP367	Straight
CP367-1	Curved



### Cartilage Scissors

Catalog #	Description
CP350	Serrated, Straight, 185mm (7¼")
CP353	Curved, 100mm (3⅞")



### Converse Scissors

Overall length 97mm (3⅞")

Catalog #	Description
CP348	18.0mm, Angled Blades



### Cottle Scissors

Overall length 156mm (6¼")

Catalog #	Description
CP614	Straight Blades, Angled Handles

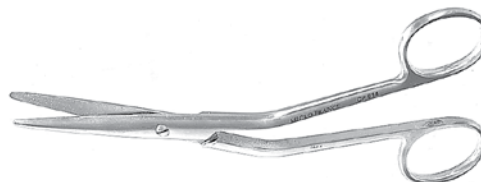

### Cottle-Pech Scissors

Catalog #	Description
CP635	Angled Blades, 142mm (5⅝")



### Dissecting Scissors

Semi-Sharp Outer Edges

Catalog #	Description
CP357-1	Curved, 163mm (6½")
CP357-2	Curved, 207mm (8¼")



CP357-1

### Facelift Scissors, W/Guard

Catalog #	Description
CP369-1	44.0mm Jaw Length, 188mm (7½")
CP369-2	33.5mm Jaw Length, 188mm (7½")
CP369-3	37.0mm Jaw Length, 194mm (7¾")



CP369-2

### Fomon Scissors

Catalog #	Description
CP612	Full Curved, 142mm (5⅝")
CP613	Angled, 136mm (5⅜")



CP613

### Heymann-Klossek Scissors

Overall length 177mm (7")

Catalog #	Description
CP615-1	Straight, Serrated
CP615-2	Curved Left, Serrated
CP615-3	Curved Right, Serrated



CP615-1

### Joseph Scissors

Catalog #	Description
CP919	Straight, 110mm (4⅜")
CP919-A	Curved, 110mm (4⅜")



CP919-A

### Kilner-Jost Scissors

Catalog #	Description
CP362	Curved, 122mm (4¾")



### Leger Scissors

Catalog #	Description
CP365	Curved, 143mm (5⅝")



### Micro Scissors, Spring Handled

Overall length 138mm (5⅜")

Catalog #	Description
MCM970	17.0mm, Curved



### Offret Stitch Scissors

Catalog #	Description
CP356	Straight, 97mm (3⅞")



### Pellegrini Dorsal Scissors

Overall length 151mm (6")

Catalog #	Description
CP359	Straight Blades, Angled Handles



### Peynegre Nasal Scissors

Catalog #	Description
MCEN41-1	11.0mm Straight



### Straight Scissors

Catalog #	Description
CP360	Straight, 155mm (6")



### Ragnell Undermining Scissors Flat Tip Blades

Catalog #	Description
CP616-13	Curved, 135mm (5 <sup>3</sup> / <sub>8</sub> "
CP616-15	Curved, 150mm (5 <sup>7</sup> / <sub>8</sub> "

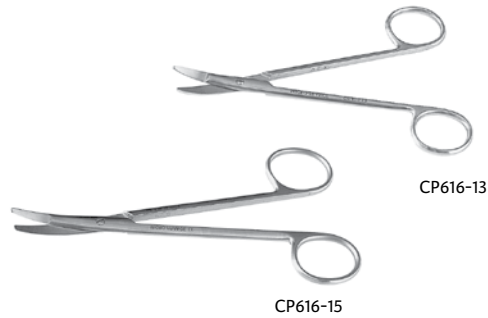

### Reynolds Scissors

Catalog #	Description
CP921	Straight, 158mm (6 <sup>1</sup> / <sub>4</sub> "



### Rouvier Scissors

Working length 100mm (3<sup>7</sup>/<sub>8</sub>"

Catalog #	Description
MCEN42	10.0mm Blades, Serrated, Curved Left
MCEN42-1	10.0mm Blades, Serrated, Curved Right



### Shea Vein Graft Scissors

Overall length 120mm (4<sup>3</sup>/<sub>4</sub>"

Catalog #	Description
CP637	Curved, Flat Dissecting Tips



### Stevens Tenotomy Scissors

Overall length 115mm (4½")

Catalog #	Description
CP922A	16.0mm, Curved
CP922B	14.0mm, Straight
CP922	21.5mm, Straight

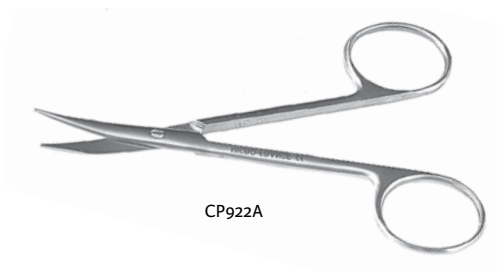

CP922A

### Vannas Scissors

Overall length 137mm (5¾")

Catalog #	Description
MCM7R	10.6mm, Straight
MCM7BISR	10.6mm, Curved



MCM7R

### Weit Scissors

Working length 72mm (2⅞"), Bayonet

Catalog #	Description
N480G	11.5mm Blades, Straight



**SPECULA**

**Palmer Nasal Specula**

Catalog #	Description
7742-1	Size No. 1
7742-2	Size No. 2
7742-3	Size No. 3

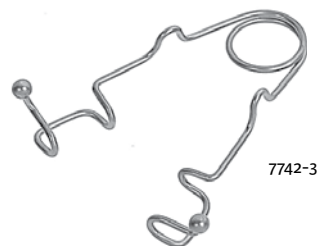

**Palmer Piquet Specula**

Catalog #	Description
7896-1	1.2mm Dia., 8.5 x 11.6mm
7896-2	1.3mm Dia., 8.0 x 13.0mm
7896-3	1.4mm Dia., 8.5 x 11.6mm

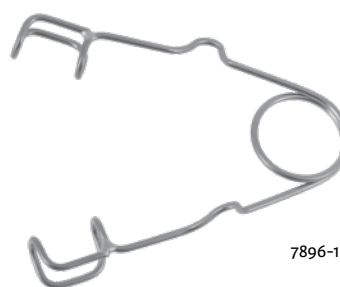

**Vacher Nasal Specula**

Catalog #	Description
7746A*	Child Size
7746B*	Adult Size

\*Not for sale in US



**MISCELLANEOUS**

**Areola Breast Markers**

Catalog #	Description
CP961	42.0mm, Freeman Pattern
CP961-1	42.0mm, Smooth Pattern

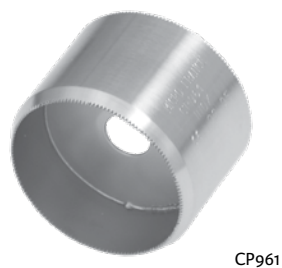

### Defourmental Breast Markers

Catalog #	Description
-----------	-------------

CP980-35	35.0mm
CP980-40	40.0mm
CP980-45	45.0mm
CP980-50	50.0mm
CP980-55	55.0mm



CP980-45

### Mole Breast Tensor

Overall length 315mm (12<sup>3</sup>/<sub>8</sub>" )

Catalog #	Description
-----------	-------------

CP981	Opening, Minimum 55mm, Maximum 123mm
-------	--------------------------------------



### Bone Awl

Overall length 165mm (6<sup>1</sup>/<sub>2</sub>" )

Catalog #	Description
-----------	-------------

M823A	1.0mm
M823B	2.0mm
M823D	4.0mm



M823B

### Bone Graft Driver

Catalog #	Description
-----------	-------------

M821A	8.1mm, 101.0mm (4")
-------	---------------------





INTEGRA<sup>®</sup>  
LIMIT UNCERTAINTY



Integra<sup>®</sup> MicroFrance<sup>®</sup>

Sinus Instrumentation

### Duncavage Sphenoid Sinus Instrument Set

The Duncavage Sphenoid Sinus Set was developed to allow access to the interior of the sphenoid sinus. These instruments help surgeons remove cysts and bone, as well as strip mucosa and palpate masses within the sphenoid sinus. All of the Duncavage instruments feature a 25° bend superiorly and a 25° bend inferiorly at the distal tips that allow the surgeon to help access the sphenoid sinus. They also feature reverse-action handles that help reduce the amount of movement at the distal tips when actuated.

Developed in conjunction with James A. Duncavage, MD



MCEN151



MCEN152



MCEN153



MCEN154

Catalog #	Description
-----------	-------------

MCEN150**	Duncavage Sphenoid Sinus Set
-----------	------------------------------

Set consist of the following;

Catalog #	Description
-----------	-------------

MCEN151	Sphenoid Sinus Vertical Cup Forceps, 2.5mm, 94mm (3¾ ")
---------	---

MCEN152	Sphenoid Sinus Horizontal Cup Forceps, 7.0mm, 93mm (3¾ ")
---------	---

MCEN153	Sphenoid Sinus Vertical Thru-Cut Forceps, 3.0mm, 93mm (3¾ ")
---------	--

MCEN154	Sphenoid Sinus Horizontal Thru-Cup Forceps, 7.3mm, 93mm (3¾ ")
---------	--

MCEN155	Sphenoid Sinus Blunt Probe, 2.5mm, 140mm (5½ ")
---------	---

MCEN156	Sphenoid Sinus Blunt Probe W/Suction, 2.9mm, 131mm (5-1/8")
---------	---

MCEN157	Sphenoid Sinus Freer Elevator, 3.0 x 17.0mm, 140mm (5½ ")
---------	---

MCEN158	Sphenoid Sinus Freer Elevator W/Suction, 2.7 x 12.0mm, 132mm (5¼ ")
---------	---

3717002	Instrument Tray, 52cm L x 25cm W x 2.8cm D, (20½" L x 9¾" W x 1⅛" D)
---------	--



MCEN155



MCEN156



MCEN157



MCEN158

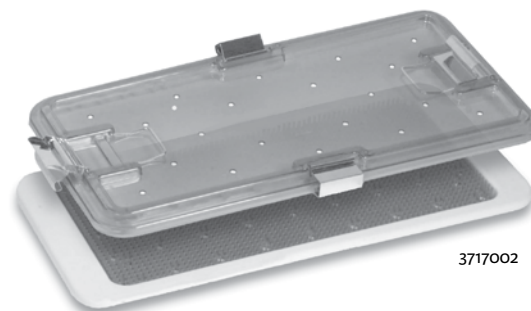

3717002

\*\*Not for sale outside US

### Kennedy Frontal Sinus Instrument Set

This set of malleable instruments has been designed to aid in preservation of mucosa within the frontal recess and frontal sinus.

Developed in conjunction with David W. Kennedy, MD



MCSKo

Catalog #	Description
-----------	-------------

MCSKo**	Kennedy Frontal Sinus Surgery Instrument Set
---------	--

Set consist of the following;

Catalog #	Description
-----------	-------------

MCSK1	Malleable Blunt Probe, Round Tip, 152mm (6")
MCSK2	Malleable Sharp Knife, 152mm (6")
MCSK3	Malleable Hook, Vertical, 152mm (6")
MCSK4	Malleable Hook, Back, 152mm (6")
MCSK5	Malleable Suction, 6FR., 123mm (4 7/8")
MCSK6	Malleable Curette, 2.0mm Cup, 152mm (6")
MCSKoSC	Instrument Tray, One-Level, 19.8cm L x 11cm W x 2.2cm D, (7 3/4" L x 4 3/8" W x 7/8" D)

\*\*Not for sale outside US



MCSK1



MCSK2



MCSK3



MCSK4



MCSK5



MCSK6

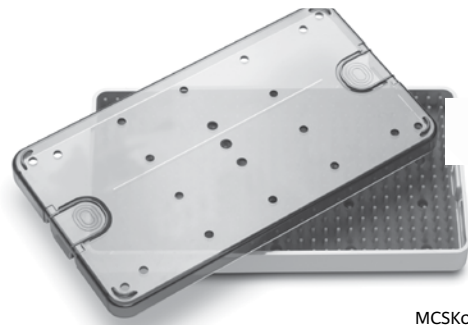

MCSKoSC

### Levine Orbital Decompression Instrument Set

The Levine Orbital Decompression Instrument Set is suited for intranasal endoscopic orbital decompression. The Levine Perforator is designed to create the initial opening through the medial orbital wall (lamina papyracea). The 15 degree angled suction curettes and picks are designed to help gently remove the lamina. The angled sickle knife incises the periorbita to liberate the orbital fat. The angled sickle knife incises the periorbita to liberate the orbital fat. The serrated jaws of the angled forceps do not completely close, allowing for a firm, yet atraumatic grip to assist in teasing the orbital fat into the sinus cavity. The 10-instrument set is provided with an instrument tray.

Developed in conjunction with Howard L. Levine, MD

Catalog #	Description
MCEN160**	Levine Orbital Decompression Instrument Set

Set consist of the following;

Catalog #	Description
MCEN161	Orbital Ring with Suction, 208mm (8¼")
MCEN162	Orbital Knife, 185mm (7¼")
MCEN163	Orbital Suction Pick, 90°, 208mm (8¼")
MCEN164	Orbital Suction Pick, 45°, 208mm (8¼")
MCEN165	Orbital Suction Pick, 135°, 208mm (8¼")
MCEN167	Orbital Suction Curette, 90°, 209mm (8¼")
MCEN168	Orbital Sickle Knife, 230mm (9")
MCEN169	Orbital Forceps, 45°, 118mm (4⅝")
MCEN170	Orbital Curette Dissector, 250mm (9¾")
MCEN171	Orbital Perforator Elevator, 250mm (9¾")
3717002	Instrument Tray, 52cm L x 25cm W x 2.8cm D, (20½" L x 9¾" W x 1⅛" D)

\*\*Not for sale outside US

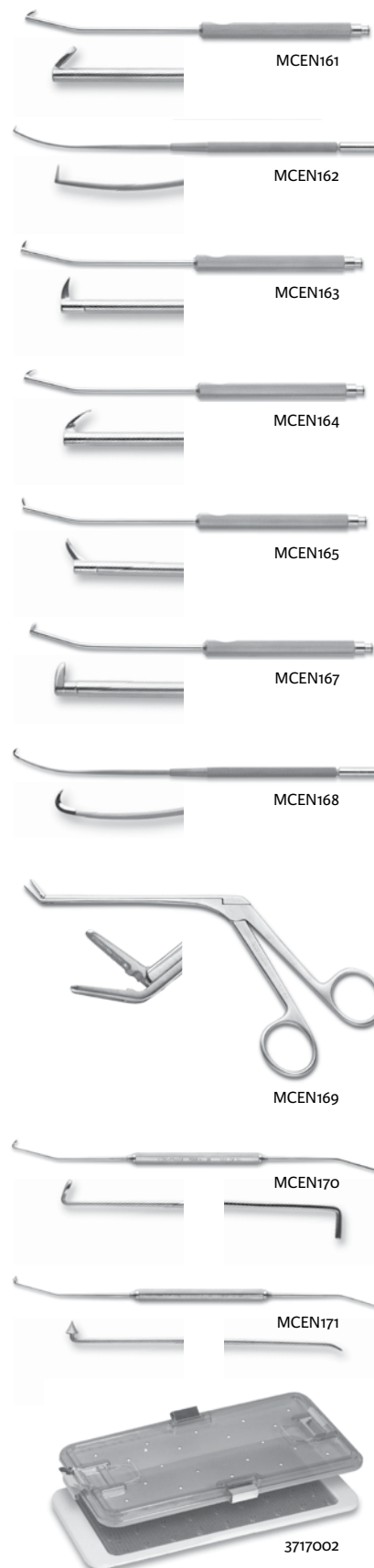

### Parsons Minimally Invasive Sinus Instrument Set

Developed to complement powered sinus surgery instrumentation, the Parsons Minimally Invasive Sinus Set features 11 instruments specially designed for sinus surgery.

Developed in conjunction with David Parsons, MD, FACS, FAAP



MCEN7600

Catalog #	Description
MCEN7600**	Parsons Minimally Invasive Sinus Set

Set consist of the following;

Catalog #	Description
MCEN27-2	Pedi Backbiting Fcps, 2.0 x 4.0mm, Down, Working Length 84mm (3¼")
MCEN760	Push-Pull Antrostomy Blade, 10.0mm, Working Length 70mm (2¾")
MCEN761	Push-Pull Antrostomy Blade, 7.0mm, Working Length 70mm (2¾")
MCEN762	Sinus Probe, 30/90°, 7.0mm, Working Length 77mm (3")
MCEN763	Sinus Probe, 30/90°, Flat, 7.0mm, Working Length 77mm (3")
MCEN764	Suction Elevator, Sharp, 4.2 x 10.0mm, Working Length 82mm (3¼")
MCEN765	Suction Elevator, Blunt, 4.2 x 7.5mm, Working Length 82mm (3¼")
MCEN766	Sinus Suction Tube, 4.0mm, Working Length 90mm (3½")
MCEN767	Sinus Suction Tube, 5.0mm, Working Length 90mm (3½")
MCEN768	Suction Curette, 2.0 x 3.0mm Cup, 90°, Working Length 110mm (4¾")
MCEN769	Suction Curette, 2.0 x 3.0mm Cup, 60°, Working Length 110mm (4¾")
3717010	Instrument Tray, 53cm L x 25cm W x 4cm D, (20¾" L x 9¾" W x 1½" D)

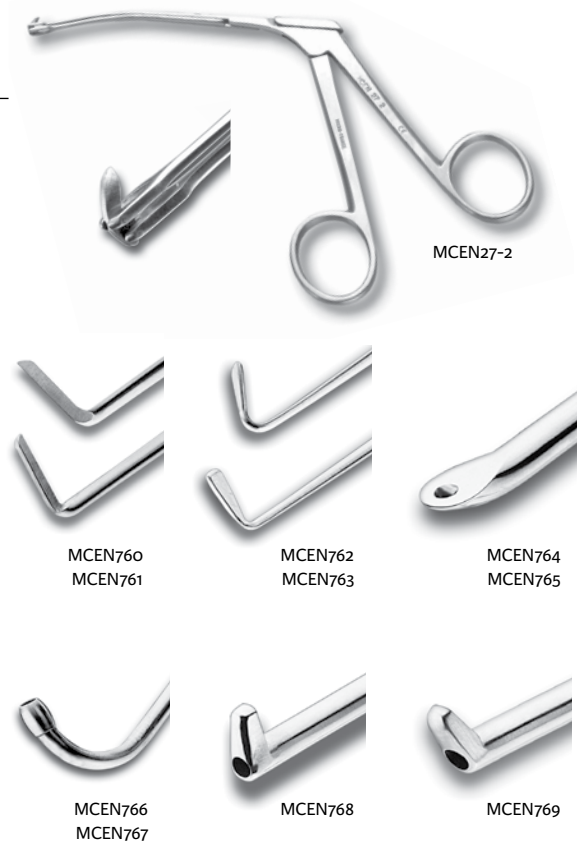

\*\*Not for sale outside US

### Parsons Accessories

(Not included in set)

Catalog #	Description
MCEN720	Hockey Stick Seeker, Sharp, Double-Ended, Overall Length 185mm (7¼")
MCEN721	Unicinate Seeker, Angled, Double-Ended, Overall Length 195mm (7¾")
MCEN723	Maxillary Seeker, Curved, Double-Ended, Overall Length 190mm (7½")

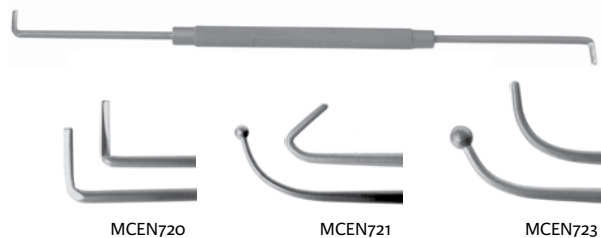



### Stamm Skull Base Instrument Set

The Stamm Skull Base Instrument Set is commonly used for both otolaryngologists and neurosurgeons in a combined approach to transnasal endoscopic skull base surgery and pituitary procedures. This set consists of 16 instruments, including elevators, scissors, suctions, cup forceps, a hook, probes, and bipolar forceps.

Developed in conjunction with Aldo Stamm, MD, PhD

Catalog #	Description
MCEN320**	Stamm Skull Base Instrument Set

Set consist of the following;

Catalog #	Description
MCEN328S	Cup Forceps, Bayonet, 2.5mm Cup, Straight, 154mm (6")
MCEN328U	Cup Forceps, Bayonet, 2.5mm Cup, Up, 150mm (5 7/8")
MCEN329	Hook, 90°, Sharp, 160mm (6 1/4")
MCEN330	Ball Seeker, 90°, 160mm (6 1/4")
MCEN344S	Scissors, Bayonet, 5.0mm, Straight, 152mm (6")
MCEN344U	Scissors, Bayonet, 5.0mm, 45° Up, 150mm (5 7/8")
MCEN344V	Scissors, Bayonet, 5.0mm, Curved Left, 152mm (6")
MCEN345	Elevator, 2.0mm, 160mm (6 1/4")
MCEN346	Elevator, 4.0mm, 160mm (6 1/4")
MCEN347	Malleable Suction, 3.0mm, Straight, 150mm (5 7/8")
MCEN348	Malleable Suction, 2.0mm, Straight, 150mm (5 7/8")
MCEN349	Malleable Suction, 3.0mm, Curved, 150mm (5 7/8")
MCEN350	Suction Tube, Angled, Tip Curved Down, 140mm (5 1/2")
MCEN351	Suction Tube, Angled, Tip Curved Up, 140mm (5 1/2")
MCEN364	Bipolar Forceps, 5.0mm, Angled 45°, 142mm (5 5/8")
MCEN365	Bipolar Forceps, Bayonet, 5.0mm, 142mm (5 5/8")
MCOS10SC	Instrument Tray, 38.5cm L x 25.6cm W x 12.8cm D, (15 1/4" L x 10" W x 5" D)
CP393	Bifurcated Banana Plug Bipolar Cable

\*\*Not for sale outside US

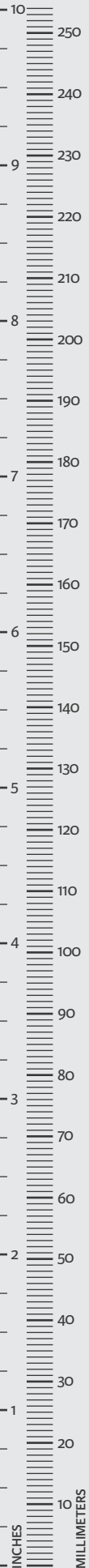
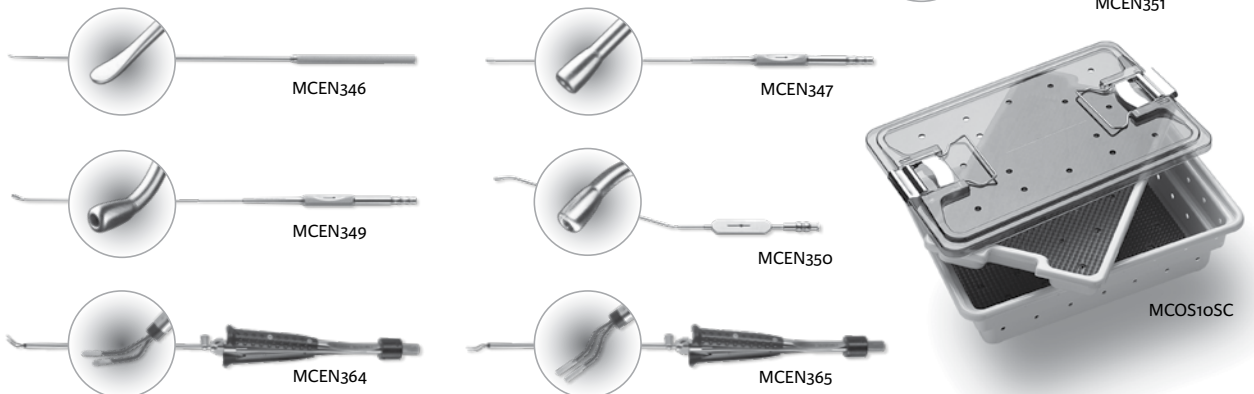

### Vaughan Suction Sinus Instruments

These instruments have been designed to evacuate blood from the surgical site to provide visibility in the sinuses.

Developed in conjunction with Winston Vaughan, MD

Catalog #	Description
MCEN110	Punch Cleaner, 4.0 and 6.0mm, Double-Ended, Working Length 121mm (4¾")
MCEN111	Suction Pick, 3.0mm, 110° Forward, Working Length 106mm (4⅛")
MCEN112	Suction Pick, 3.0mm, 90° Back, Working Length 105mm (4⅛")
MCEN114	Suction Cup Forceps, 2.8mm 30° Up Angled, Working Length 123mm (4⅞")
MCEN115-6	Malleable Suction, 6Fr, 125mm (4⅞")
MCEN115-8	Malleable Suction, 8Fr, 120mm (4¾")
MCEN115-9	Malleable Suction, 9Fr, 125mm (4⅞")
MCEN116	Suction Mushroom Punch, 4.0mm, Straight, Working Length 117mm (4⅝")
MCEN117	Suction Mushroom Punch, 4.0mm, 60° Up, Working Length 125mm (4⅞")
MCEN118	Suction Mushroom Punch, 6.0mm, Straight, Working Length 117mm (4⅝")
MCEN120	Suction Sickle Knife, 3.0mm, 105mm (4⅛")
3717002	Instrument Tray, 52cm L x 25cm W x 2.8cm D, (20½" L x 9¾" W x 1⅛" D)



MCEN110



MCEN111



MCEN112



MCEN114

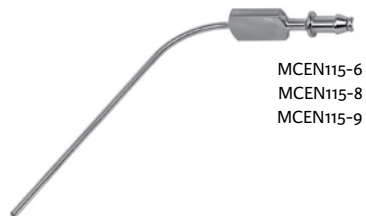

MCEN115-6  
MCEN115-8  
MCEN115-9



MCEN116



MCEN117



MCEN118



MCEN120



3717002

### Wormald Anterior Skull Base and Pituitary Instrument Set

This set of instruments was designed for both otolaryngologists and neurosurgeons in a combined approach to endoscopic anterior skull base and pituitary procedures. The set includes elongated malleable instrumentation with suction. In addition, the set contains reverse-action scissors of various sizes and orientations.

Developed in conjunction with P. J. Wormald, MD, FRACS, FRCS



Catalog #	Description
MCEN148**	Wormald Anterior Skull Base and Pituitary Instrument Set

Set consist of the following;

Catalog #	Description
MCEN138	Malleable Suction Probe, 3.0mm, 176mm (7")
MCEN139	Malleable Probe, 2.5mm, 90°, 170mm (6¾")
MCEN139A	Malleable Probe, 1.0mm, Straight, 170mm (6¾")
MCEN140	Malleable Suction Curette, 45°, Small, 175mm (7")
MCEN140A	Malleable Suction Curette, 45°, Large, 175mm (7")
MCEN141	Malleable Suction Curette, 90°, Small, 175mm (7")
MCEN141A	Malleable Suction Curette, 90°, Large, 175mm (7")
MCEN142	Malleable Suction Basket, 177mm (7")
MCEN143	Instrument Tray, 52cm L x 24.5cm W x 12cm D, (20½" L x 9¾" W x 4¾" D)
MCEN147	Malleable Suction Elevator, 3.5mm, 176mm (7")
MCEN214	Pituitary Forceps, 1.5 x 6.0mm, Straight, 168mm (6½")
MCEN215	Pituitary Forceps, 1.5 x 4.5mm, 45° Up, 166mm (6½")
MCEN216L	Pituitary Scissors, 6.0mm, Left, 168mm (6½")
MCEN216R	Pituitary Scissors, 6.0mm, Right, 168mm (6½")
MCLW10	Pituitary Scissors, 5.0mm, Straight, 202mm (8")
MCLW11	Pituitary Scissors, 5.0mm, Up, 202mm (8")
MCEN217L	Pituitary Scissors, 8.0mm, Left, 170mm (6¾")
MCEN217R	Pituitary Scissors, 8.0mm, Right 170mm (6¾")
MCEN217S	Pituitary Scissors, 8.0mm, Straight, 170mm (6¾")
MCEN217U	Pituitary Scissors, 8.0mm, Up, 170mm (6¾")
MCEN149W	Bending Tool, 150mm (5⅞")



\*\*Not for sale outside US



### Wormald Anterior Skull Base and Pituitary Instrument Set Cont'd

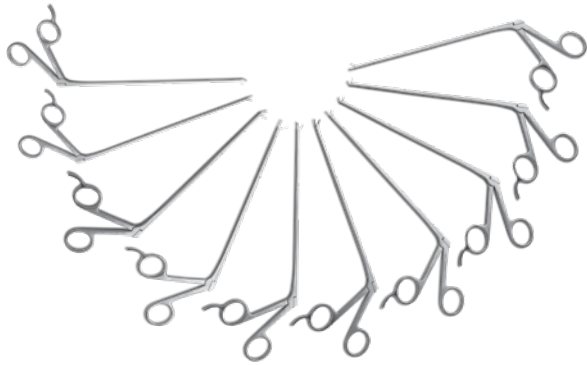

MCEN214



MCEN215



MCEN216L



MCEN216R



MCLW10



MCLW11



MCEN217L



MCEN217R



MCEN217S



MCEN217U



MCEN149W

**Wormald Anterior Skull Base and Pituitary Instrument Accessories**  
(Not included in set)

Catalog #	Description
MCEN138S	Malleable Suction Probe, 1.5mm, 175mm (7")



**Wormald Hemorrhage Control Set**

Catalog #	Description
MCEN189**	Wormald Hemorrhage Control Set

Set consist of the following;

Catalog #	Description
MCEN190	Clamp, Straight, Rotatable, 173mm (6¾")
MCEN191	Clamp, Curved, Small, 173mm (6¾")
MCEN192	Clamp, Curved, Long, 167mm (6½")
MCEN193	Clamp, 45°, Straight, 163mm (6½")
MCEN194	Clamp, 45°, Curved, Small, 162mm (6⅜")
MCEN195	Clamp, 45°, Curved, Long, 162mm (6½")
MCEN212	Clip-Applying Forceps, Rotatable, Straight*
MCEN213	Clip-Applying Forceps, Rotatable, 45° Shaft*
MCEN218	Needle Holder, Rotatable, 170mm (6¾")
MCOHoSC	Instrument Tray, 54.6cm L x 25.9cm W x 12cm D (21½" L x 10¼" W x 4¾" D)



MCEN190



MCEN191



MCEN192



MCEN193



MCEN194



MCEN195



MCEN211\*  
MCEN211S\*\*



MCEN212\*  
MCEN212S\*\*



MCEN213\*  
MCEN213S\*\*



MCEN218

\*\*Not for sale outside US

**Wormald Hemorrhage Control Set Accessories**

Catalog #	Description
MCEN211	Clip-Applying Forceps, Rotatable, 45° Jaw*
MCEN211S	Clip-Applying Forceps, Rotatable, 45° Jaw**
MCEN212S	Clip-Applying Forceps, Rotatable, Straight**
MCEN213S	Clip-Applying Forceps, Rotatable, 45° Shaft**

\*Compatible with Ethicon Medium Clips LT200

\*\*Compatible with Ethicon Small Clips LT100



MCEN218

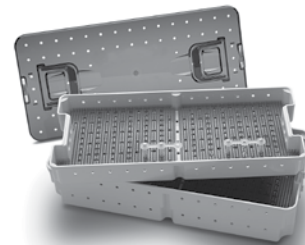

MCOHoSC

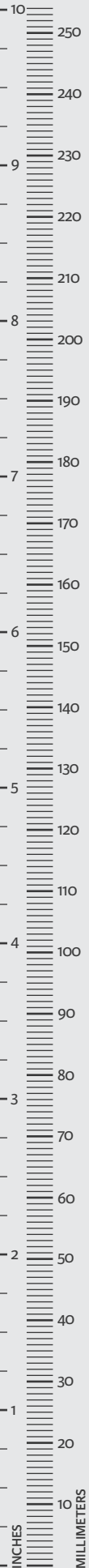

### Wormald Frontal Sinus Surgery Instrument Set

This malleable set of instruments has been designed to aid in preservation of mucosa within the frontal recess and frontal sinus. The set includes five instruments and an instrument tray. Each instrument has a working length of 11cm with an outer diameter ranging from 2.0mm to 2.5mm. The last 4cm of each instrument is malleable for access across a wide range of anatomies. A variable suction design on the malleable suction probe, freer suction elevator, and sharp-cupped suction curette allows the surgeon to control the amount of suction through a thumb-controlled aperture.

Developed in conjunction with P. J. Wormald, MD, FRACS, FRCS



Catalog #	Description
MCEN136**	Wormald Frontal Sinus Surgery Instrument Set

Set consist of the following;

Catalog #	Description
MCEN130	Malleable Sinus Probe, Double-Ended, 260mm (10¼")
MCEN131	Malleable Suction Probe, 115mm (4½")
MCEN133	Malleable Suction Elevator, Blunt, 115mm (4½")
MCEN134	Malleable Suction Curette, Sharp Cup, 115mm (4½")
MCEN135	Knot Pusher, 3.0mm, 92mm (3⅝")
MCEN136SC	Instrument Tray, 285mm L x 175mm W x 50mm D (11¼" L x 7" W x 2" D)
MCEN149W	Bending Tool, 150mm (5⅞")

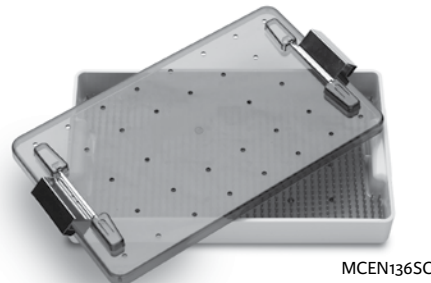

\*\*Not for sale outside US

### Albertini Catheter Guide

Catalog #	Description
7771B	Overall length 255mm (10")



### Albertini Drain Tube

Catalog #	Description
7771AS10*	10/Pkg

\*Not for sale in US



### Albertini Trocar and Cannula

Overall length 160mm (6 1/4")

Catalog #	Description
7771	4.0mm x 53.0mm Cannula, Straight
7771C	4.0mm x 82.0mm Cannula, Curved



7771

### Freche Sinus Curette

Catalog #	Description
MCEN104	6.2 x 9.2mm, 224mm (8¾")



### Jankowski Sinus Curette

Catalog #	Description
MCEN109	4.2 x 6.4mm, 219mm (8½")



### Klossek Curette

Overall length 200mm (7¾"), Double-Ended

Catalog #	Description
MCEN106	2.15 x 6.5mm - 2.15 x 4.2mm



### Klossek Curette/Elevator

Overall length 200.0mm (7¾"), Double-Ended

Catalog #	Description
MCEN107	Curette, 2.1 x 7.5mm Elevator, 1.0 x 6.2mm



### LDG Sinus Curette

Working length 122mm (4¾")

Catalog #	Description
MCEN68ADG	3.4 x 6.4mm Cup Insert, Angled Up
MCEN68BDG	3.5 x 5.8mm Cup Insert, Angled Up
MCEN68CDG	3.5 x 5.8mm Cup Insert, Straight
MCEN728DG	De Gabory LDG Modular Handle



MCEN68BDG

### Cottle Septum Elevator

Overall Length 224mm (8¾"), Double-Ended

Catalog #	Description
CP626	Elevator, 3.3mm Round Blade, 4.4mm



### Cottle-Mckenty Elevator

Overall length 214mm (8½"), Double-Ended

Catalog #	Description
CP627	4.3 and 4.1mm Wide Tips



### Dissector/Elevator

Overall length 175mm (7"), Double-Ended

Catalog #	Description
CP511	Dissector, 5.6mm Elevator, 3.9mm

### Guillen Suction Tube-Elevator

Overall Length 200mm (7¾"), Bayonet

Catalog #	Description
CP337-1	6.2mm Tip



### Herman Knife/Elevator

Overall length 236mm (9¼")

Catalog #	Description
MCEN127	4.4 x 6.0mm

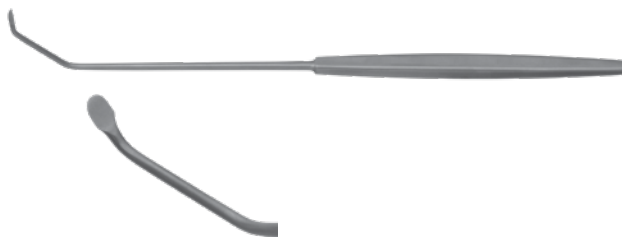

### Howarth Elevator

Overall length 223mm (8¾"), Double-Ended

Catalog #	Description
CP625	Elevator, 6.8mm, Rasp, 3.5mm



### Joseph Periosteal Elevator

Overall length 185mm (7¼")

Catalog #	Description
CP310	5.0 x 23.0mm, Curved
CP310E	4.0 x 24.0mm, Light Curve
CP310D	5.0 x 24.0mm, Straight



CP310E

### Prades Elevator

Catalog #	Description
MCEN55	7.3mm, Angled, 212mm (8¼")



### Suction Tube-Elevator

Working length 75mm (3")

Catalog #	Description
7878	2.5mm I.D., 5.0mm O.D.

### Rouvier Suction Tube-Elevator

Working length 129mm (5½"), Malleable

Catalog #	Description
MCEN10	2.5mm Tip



### Backbiting Forceps

Available in four sizes, the MicroFrance® Backbiting Forceps provide an outstanding cutting edge, thin shaft, and strong cutting capability while working in the nasal cavity. Trying to use a shaver on the unciniate process can be difficult, so these specialized backbiters allow a reverse approach when removing or making an opening in the unciniate process during sinus surgery.

They also provide a better alternative to traditional backbiting forceps because of their unique downward sloping shaft. The slim profile and tapered shaft design of these forceps fit ideally into the middle meatus to aid in reducing trauma to the middle turbinates during surgery. MCEN27-3 features a distinctive gentle upward curved shaft for accessing difficult-to-reach areas of the sinus.

Catalog #	Description
MCEN27	Adult, Backbiting Forceps, 4.0 x 7.0mm, 110mm (4 <sup>3</sup> / <sub>8</sub> " )
MCEN27-1	Adult, Backbiting Forceps, 3.5 x 6.8mm, 84mm (3 <sup>1</sup> / <sub>4</sub> " )
MCEN27-2	Pediatric, Backbiting Forceps, 2.0 x 4.2mm, 84mm (3 <sup>1</sup> / <sub>4</sub> " )
MCEN27-3	Pediatric, Backbiting Forceps, Up, 2.0 x 4.2mm, 84mm (3 <sup>1</sup> / <sub>4</sub> " )

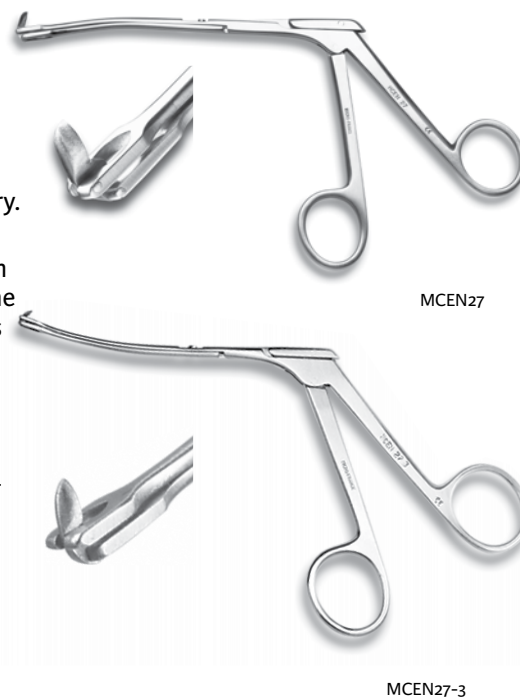

### Backbiting Forceps, Rotatable

Working length 80mm (3<sup>1</sup>/<sub>8</sub>" )

Catalog #	Description
MCEN27R	2.5mm x 7.6mm Jaw



### Bipolar Electrode

Catalog #	Description
MCEN54H	4.8 x 11.0mm Tapered, 190mm (7 <sup>1</sup> / <sub>2</sub> " )



### Blakesley Forceps

Working length to 102mm (4" )

Catalog #	Description
7762B-1	3.2mm x 10.8mm, Angled 90°





### Blakesley Forceps-Fenestrated

Working length to 110mm (4<sup>3</sup>/<sub>8</sub>" )

Catalog #	Description
7763	2.1mm x 7.2mm, Straight
7763-1	2.1mm x 7.5mm, Angled 45°
7763-2	2.6mm x 5.0mm, Angled 90°



### Bossard Cup Forceps-Fenestrated

Working length 160mm (6<sup>1</sup>/<sub>4</sub>" ), Double-Action

Catalog #	Description
MCEN53	2.4 x 4.8mm Cup



### Citelli-Freche Forceps

Working length 116mm (4<sup>5</sup>/<sub>8</sub>" )

Catalog #	Description
MCEN12	3.0mm Bite



### Citelli Punch Forceps

Working length to 85mm (3<sup>3</sup>/<sub>8</sub>" )

Catalog #	Description
7764*	3.0mm, Angled 90°

\*Not for sale in US



### Clip-Aplying Forceps

Compatible with Ethicon Medium Clips LT200

Catalog #	Description
MCEN21R	Clip-Aplying Forceps, Rotatable, 122mm (4¾")
MCEN21	Clip-Aplying Forceps, Non-Rotatable, 109mm (4¼")



### Dessi Bipolar Forceps

Developed in conjunction with Patrick Dessi, MD

Catalog #	Description
MCEN54K**	Dessi Bipolar Forceps Set

Set consist of the following;

Catalog #	Description
MCEN54	Bipolar Forceps, 2.5 x 7.0mm, 121mm (4¾")
MCEN640	Instrument Tray, 38.5cm L x 25.8cm W x 5cm D (15¼" L x 10¼" W x 2" D)
CP393	Bifurcated (Banana Plug) Bipolar Cord 4.5m (14'-¾")

\*\*Not for sale outside US



### Dessi Bipolar Forceps, Detach

Catalog #	Description
MCEN54I	2.5mm x 7.0mm, 183mm (7¼")
MCEN54G	Bipolar Outer Tube, 5.0mm O.D., 93mm (3⅝")
MCEN54P	Bipolar Handle

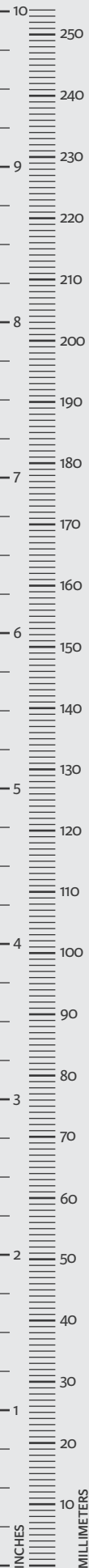
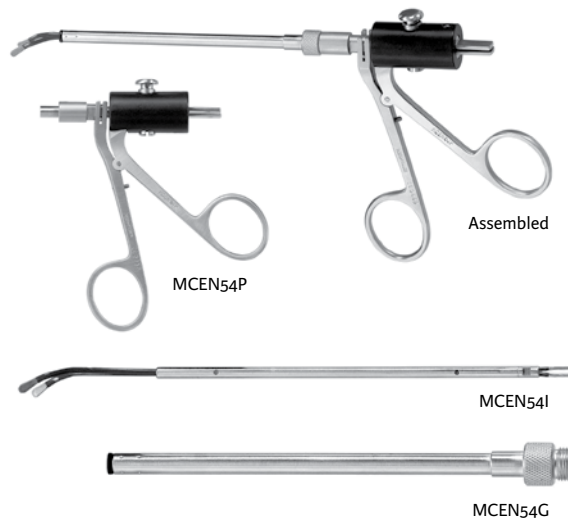

**Dessi Universal Cup Forceps**

Working length 123mm (4<sup>7</sup>/<sub>8</sub>"

Catalog #	Description
MCEN61	3.2 x 9.8mm Jaw, Angled Up



**Faure Fenestrated Forceps**

Catalog #	Description
CEP10	8.0 x 20.0mm Jaws, 110mm (4 <sup>1</sup> / <sub>8</sub> "



**Fenestrated Cup Forceps**

Working length 100 mm (3<sup>7</sup>/<sub>8</sub>"

Catalog #	Description
MCEN33	3.0 x 10.0mm Cup, Straight
MCEN34	3.0 x 10.0mm Cup, Angled Up

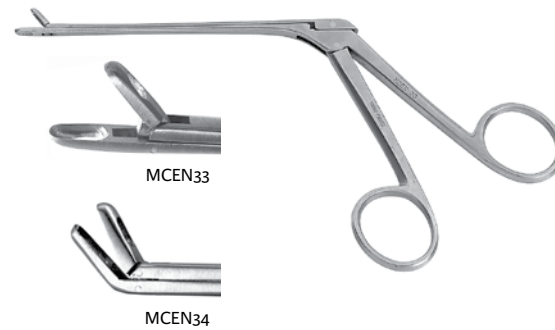

**Frontal Recess Forceps**

Working length 112mm (4<sup>3</sup>/<sub>8</sub>"

Catalog #	Description
MCEN94	2.5 x 5.0mm Cup Jaws, Angled Right 45°
MCEN95	2.5 x 5.0mm Cup Jaws, Angled Left 45°

### Fenestrated Cup Forceps W/Cleaning Port

Working length to 95mm (3¾")

Catalog #	Description
MCEN96	4.6mm Right Bite, Angled Up 45°
MCEN97	4.6mm, Left Bite, Angled Up 45°

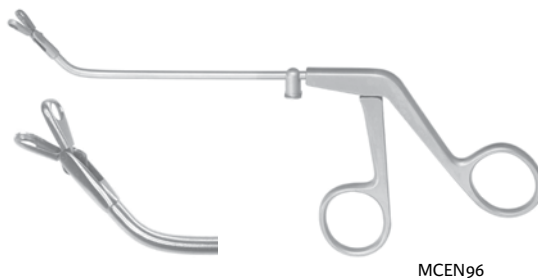

MCEN96

### Jankowski Cup Forceps W/Cleaning Port

Working length 95mm (3¾")

Catalog #	Description
MCEN350H	2.6 x 5.0mm, Horizontal, Angled Up 110°
MCEN350V	2.6 x 5.0mm, Vertical, Angled Up 110°
MCEN360H	2.6 x 5.0mm, Horizontal, Angled Up 90°, 83mm (3½")

\*Not for sale in US



MCEN350V

### Jankowski Cup Forceps W/Cleaning Port

Catalog #	Description
MCEN35JH*	Cup Jaws, Horizontal, Angled Up
MCEN35JV*	Cup Jaws, Vertical, Angled Up
MCEN36JH*	Cup Jaws, Horizontal, Angled Up 110°

\*Not for sale in US

### Jankowski Cup Forceps

Working length 100mm (3⅞")

Catalog #	Description
7762A4	4.0 x 14.0mm Cup Jaws, Angled Up 90°



### Jankowski Cup Forceps

Catalog #	Description
MCEN96J*	Cup Jaws, Horizontal, Angled Up 80°

\*Not for sale in US

### Jankowski Cup Forceps, Fenestrated

Catalog #	Description
MCEN62T1	3.2 x 9.0mm, Straight, 108mm (4¼")
MCEN62T2	5.4 x 15.0mm, Straight, 114mm (4½")
MCEN62T3	6.2 x 15.0mm, Straight, 114mm (4½")
MCEN62A1	3.2 x 9.4mm, Angled Up 45°, 107mm (4¼")
MCEN62A2	5.3 x 13.6mm, Angled Up 45°, 110mm (4⅜")
MCEN62A3	6.0 x 14.0mm, Angled Up 45°, 110mm (4⅜")
MCEN62B1	3.2 x 9.4mm, Angled Up 90°, 102mm (4")
MCEN62B2	5.2 x 13.8mm, Angled Up 90°, 102mm (4")
MCEN62B3	6.0 x 15.2mm, Angled Up 90°, 102mm (4")

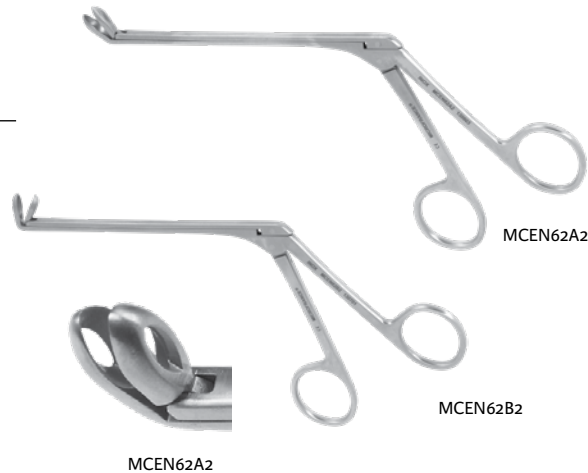

### Jankowski Heartshaped Cup Forceps

Catalog #	Description
MCEN360V	3.5 x 7.0mm, Vertical, Angled Up 90°
MCEN960H	6.2 x 7.5mm, Horizontal, Angled Up 80°



### Jansen-Middleton Forceps

Working length 108mm (4¼"), Double-Action

Catalog #	Description
CP621	5.3 x 20.0mm Cup Jaws



### Josephine Terrier Punch Forceps

Working length 98mm (3⅞")

Catalog #	Description
MCEN38	3.0 x 12.0mm, Horizontal, Fenestrated Jaws



### Klossek Cup Forceps, Fenestrated

Working length 107mm (4 1/4")

Catalog #	Description
MCEN56	3.1 x 10.0mm Cup Jaws, Angled Right
MCEN56-1	3.1 x 10.0mm Cup Jaws, Angled Left



MCEN56-1

### Klossek Cup Forceps, W/Suction

Working length 110mm (4 3/8")

Catalog #	Description
7762-5	3.2 x 11.0mm, Cup Jaws, Straight
7762A-5	3.2 x 11.0mm, Cup Jaws, Angled Up 45°

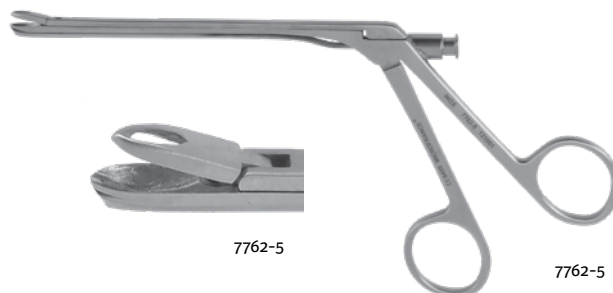

7762-5

7762-5

### Large Fenestrated Cup Forceps

Working length 100mm (4")

Catalog #	Description
MCEN90	3.3 x 12.0mm, Cup Jaws, Straight
MCEN91	3.3 x 11.0mm Cup Jaws, Angled Up 45°
MCEN91B	3.3 x 14.3mm Cup Jaws, Angled Up 45°



MCEN90

### De Gabory Laryngeal Cup Forceps W/Cleaning Port

Working length 110mm (4 3/8")

Catalog #	Description
MCEN4DG	3.5 x 9.0mm, Straight
MCEN5DG	3.5 x 9.4mm, Angled Up 45°
MCEN91DG	2.8 x 11.0mm Cup Jaws, Angled Up 45°



MCEN5DG

**Lubet Barbon Forceps**

Working length 108mm (4 1/4")

Catalog #	Description
7749	2.0 x 58.0mm, Smooth
7750	2.0 x 58.0mm, Serrated

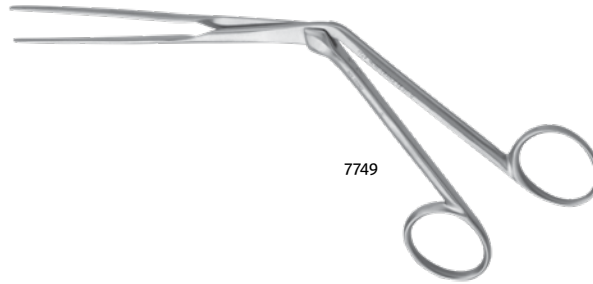

**Luc Nasal Cup Forceps**

Working length 50mm (2")

Catalog #	Description
7761-1	7.6 x 8.0mm Cup, No. 1
7761-2	9.7 x 11.0mm Cup, No. 2
7761B-1	7.9 x 8.0mm, Fenestrated Cup, No. 1
7761B-2	9.7 x 11.0mm, Fenestrated Cup, No. 2

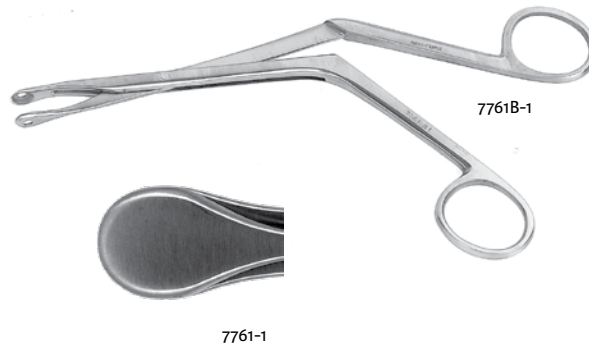

**Luc Nasal Spoon Forceps**

Working length 75mm (3")

Catalog #	Description
7761BC1	2.5 x 2.5mm, Fenestrated Spoon, No. 1
7761BC2	6.2 x 7.5mm, Fenestrated Spoon, No. 2
7761BC3	8.0 x 10.0mm, Fenestrated Spoon, No. 3
7761C1	6.5 x 6.5mm, Spoon, No. 1
7761C2	6.0 x 8.0mm, Spoon, No. 2
7761C3	8.0 x 11.0mm, Spoon, No. 3

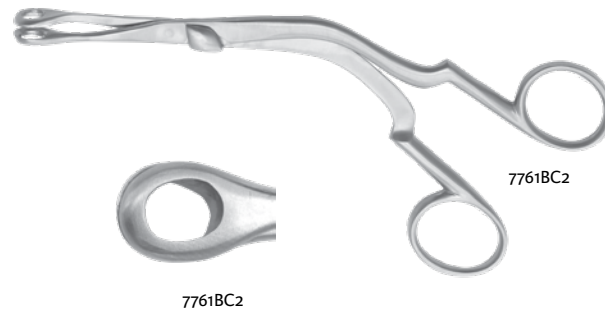

**Lucae Ear Forceps**

Overall length 151mm (6"), Bayonet

Catalog #	Description
7726MF	1.1 x 14.0mm, Serrated
7727	1.6 x 2.5mm, Cup Jaw
7728	1.2mm, 1 x 2 Teeth



### Lusk MicroBite™ Forceps

The Lusk MicroBite™ Through-Cutting Sinus Forceps are designed to resect the anterior and medial wall of the ethmoid bulla.

Developed in conjunction with Rodney P. Lusk, MD

Catalog #	Description
MCEN76**	Lusk MicroBite Forceps Set

Set consist of the following;

Catalog #	Description
MCEN73	1.4 x 5.0mm, Straight, 130mm (5 1/8")
MCEN74	1.4 x 5.0mm, Angled Up 45°, 126mm (5")
MCEN75	1.4 x 5.0mm, Angled Up 90°, 126mm (5")

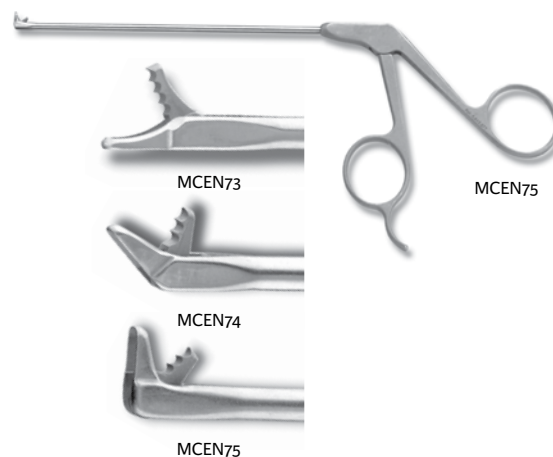

\*\*Not for sale outside US

### Mini-Struycken Through-Cutting Forceps

These through-cutting forceps with a slim profile assist in accessing the frontal recess and frontal sinus to help remove cell walls and bony partitions. The forceps are designed in both side-to-side and front-to-back biting configurations with 90 and 45 degree bends. They are also designed with rectangular jaws in the dimensions of 3.0mm wide with a 1.5mm wide bite.

Catalog #	Description
MCEN65	1.5 x 7.0mm, Straight, 116mm (4 5/8")
MCEN66	1.5 x 6.0mm, Angled Up 45°, 108mm (4 1/4")
MCEN67	1.5 x 6.0mm, Angled Up 90°, 93mm (3 5/8")
MCEN67-1	1.5 x 6.0mm, Angled Right 90°, 91mm (3 5/8")
MCEN67-2	1.5 x 6.0mm, Angled Left 90°, 91mm (3 5/8")

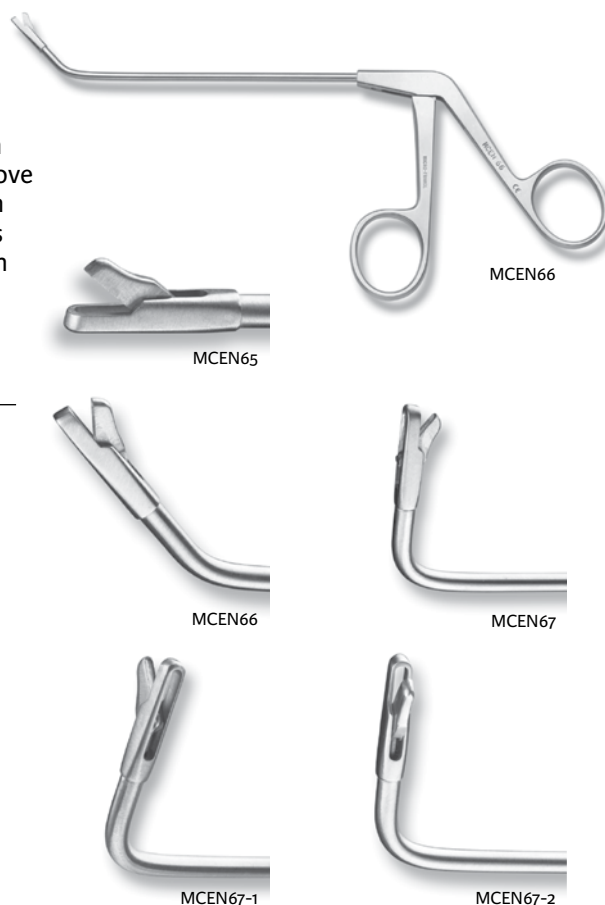



**Orsel Maxillary Forceps**

Working length 62mm (2½")

Catalog #	Description
MCEN68	3.5 x 6.2mm Cup, Curved Up



**Oval Cup Forceps**

Working length 100mm (4")

Catalog #	Description
MCEN35	2.4 x 4.8mm, Horizontal, 55°, 122mm (4¾")
MCEN36	2.4 x 5.0mm, Horizontal, 80°, 102mm (4")

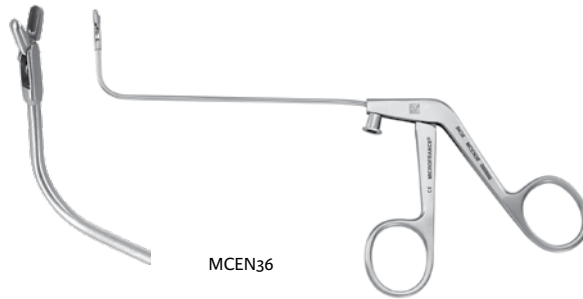

**Peynre Punch Forceps, W/Cleaning Port**

Working length 135mm (5¾")

Catalog #	Description
MCEN98	3.0 x 4.0mm, Rotating Tip
MCEN99	3.4 x 5.0mm, Horizontal Cup

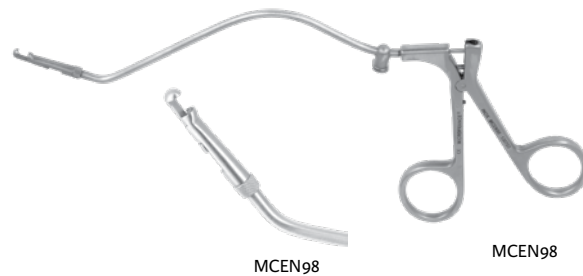

**Politzer Forceps**

Overall length to 117mm (4⅝")

Catalog #	Description
7732-1	14.0mm, Serrated
7733	1.7mm x 2.8mm, Cup Jaw
7734	1 x 2 Teeth



### Prades Alligator Forceps

Catalog #	Description
MCEN19	9.0mm Jaw, Straight, 116mm (4 <sup>5</sup> / <sub>8</sub> " )

### Rouvier Alligator Forceps

Catalog #	Description
MCEN18	10.0mm Jaw, Straight, 110mm (4 <sup>3</sup> / <sub>8</sub> " )



### Rouvier Cup Forceps

Catalog #	Description
MCEN43	1.0 x 3.5mm Cup, Angled Up 45°, 95mm (3 <sup>3</sup> / <sub>4</sub> " )
MCEN5	3.3 x 8.8mm Cup, Angled Up 45°, 108mm (4 <sup>1</sup> / <sub>4</sub> " )
MCEN5B	3.3 x 14.6mm Cup, Angled Up 45°, 112mm (4 <sup>3</sup> / <sub>8</sub> " )

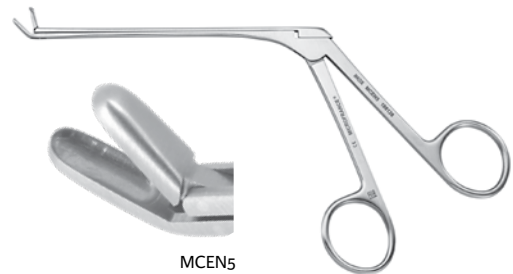

### Rouvier Cup Forceps W/Cleaning Port

Catalog #	Description
MCEN29	2.0 x 8.6mm Cup, Angled Up, 133mm (5 <sup>1</sup> / <sub>4</sub> " )
MCEN3	2.0 x 5.5mm Cup, Straight, 114mm (4 <sup>1</sup> / <sub>2</sub> " )
MCEN4	3.8 x 8.8mm Cup, Straight, 108mm (4 <sup>1</sup> / <sub>4</sub> " )



### Rouvier Punch Forceps

Catalog #	Description
MCEN49	4.0 x 7.2mm Cup, Angled Down, 99mm (3 <sup>7</sup> / <sub>8</sub> " )

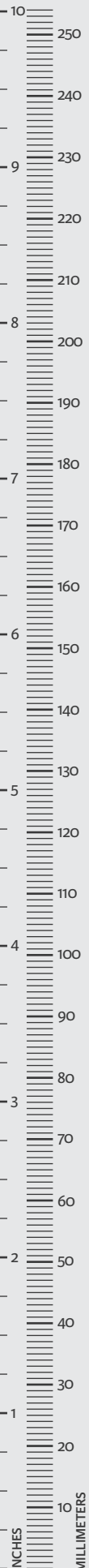

### Ruskin Bone Cutting Forceps

Overall length to 145mm (5¾")

Catalog #	Description
CP381	9.0mm Jaw, Straight, 116mm (4⅝")



### Small Fenestrated Cup Forceps

Catalog #	Description
MCEN92	2.5 x 8.0mm Cup Jaws, Straight, 116mm (4⅝")
MCEN93	2.0 x 9.0mm Cup Jaws, Angled Up 45°, 113mm (4½")

### Stamm Cup Forceps, W/ Cleaning Port

Catalog #	Description
MCEN328U	2.5mm Round Cup Jaws, 150mm (5⅞")



### Straight Cup Forceps, W/ Cleaning Port

Overall length to 138mm (5⅜")

Catalog #	Description
MCEN28	2.6 x 5.0mm Cup Jaws
MCEN28-1	2.6 x 5.0mm Serrated



### Weil-Blakesley Forceps

Working length 110mm (4⅜")

Catalog #	Description
7762-1	3.3mm Jaw, Straight, No. 1
7762-2	3.9mm Jaw, Straight, No. 2
7762A-1	3.3mm Jaw, Angled 45°, No. 1
7762A-2	3.9mm Jaw, Angled 45°, No. 2

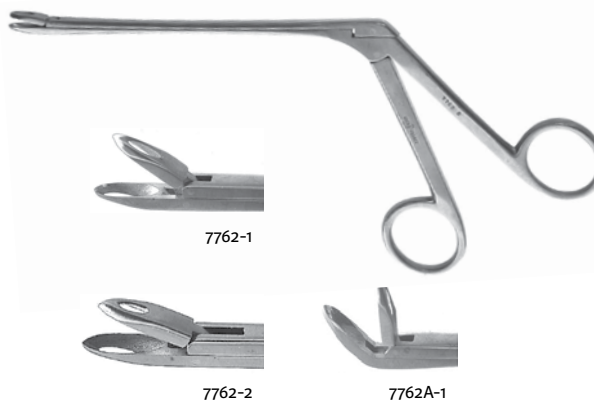

### Wormald Anterior Skull Base Clip-Appling Forceps

Working length 182mm (7¼"), W/Cleaning Port

Developed in conjunction with P. J. Wormald, MD, FRACS, FRCS

Compatible with Ethicon Medium Clips LT200

Catalog #	Description
MCEN211	Clip-Appling Forceps, Rotatable, 45° Jaw
MCEN212	Clip-Appling Forceps, Rotatable, Straight Jaw
MCEN213	Clip-Appling Forceps, Rotatable, 45° Shaft, Straight Jaw

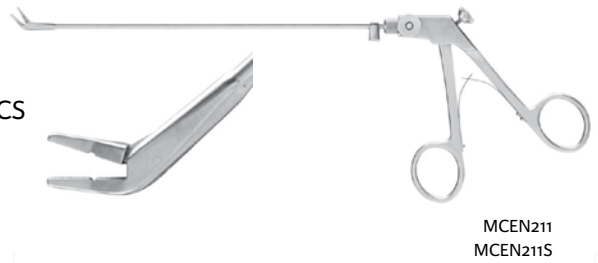

MCEN211  
MCEN211S



MCEN212  
MCEN212S

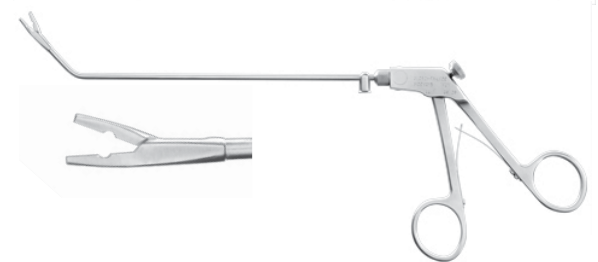

MCEN213  
MCEN213S

Compatible with Ethicon Small Clips LT100

Catalog #	Description
MCEN211S	Clip-Appling Forceps, Small, Rotatable, 45° Jaw
MCEN212S	Clip-Appling Forceps, Small, Rotatable, Straight Jaw
MCEN213S	Clip-Appling Forceps, Small, Rotatable, 45° Shaft, Straight Jaw

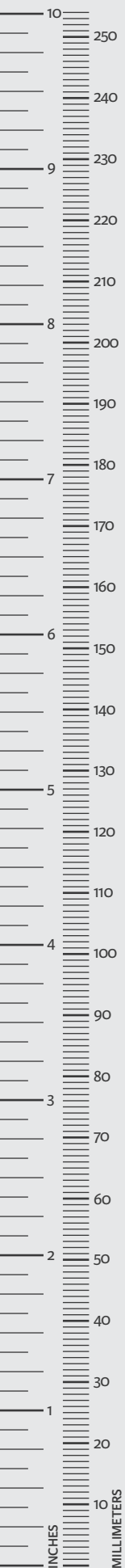

### Wormald Bipolar Forceps with Suction

Available in two lengths, the Wormald Bipolar Forceps with Suction help achieve hemostasis during endoscopic sinus and anterior skull base surgery. The longer forceps are able to reach the pituitary. Both feature a slim profile and fine tips to help provide access within difficult-to-reach areas. The integrated suction can be advanced independently of the cautery tips to help provide visibility of the operative site, and then retracted from the line of sight during cauterization. An integrated flush port facilitates cleaning and debris removal.

Developed in conjunction with P. J. Wormald, MD, FRACS, FRCS

Catalog #	Description
MCEN64K**	Wormald Bipolar Forceps with Suction Set

Set consist of the following;

Catalog #	Description
MCEN64	Bipolar Forceps with Suction, 1.1 x 6.0mm, 116mm (4 <sup>5</sup> / <sub>8</sub> " )
MCEN640	Instrument Tray for Forceps and Cables, 38.5cm L x 25.8cm W x 50cm D, 15 <sup>1</sup> / <sub>4</sub> " L x 10 <sup>1</sup> / <sub>4</sub> " W x 2" D



Catalog #	Description
MCEN641K**	Wormald Bipolar Forceps with Suction Set

Set consist of the following;

Catalog #	Description
MCEN641	Bipolar Forceps with Suction, 1.1 x 6.0mm, 171mm (6 <sup>3</sup> / <sub>4</sub> " )
MCEN640	Instrument Tray for Forceps and Cables, 38.5cm L x 25.8cm W x 50cm D, 15 <sup>1</sup> / <sub>4</sub> " L x 10 <sup>1</sup> / <sub>4</sub> " W x 2" D

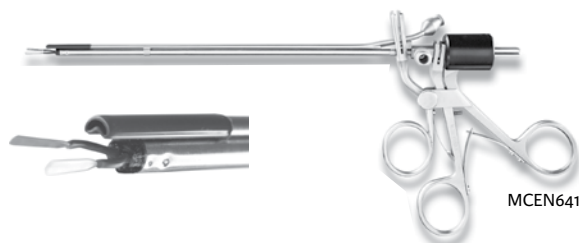

Catalog #	Description
MCEN643K**	Wormald Bipolar Forceps with Suction Set, Up-curved

Set consist of the following;

Catalog #	Description
MCEN643	Bipolar Forceps with Suction, 1.1 x 6.0mm, 171mm (6 <sup>3</sup> / <sub>4</sub> " )
MCEN644	Disposable Suction Tips, 5/PKG
MCEN640	Instrument Tray for Forceps and Cables, 38.5cm L x 25.8cm W x 50cm D, 15 <sup>1</sup> / <sub>4</sub> " L x 10 <sup>1</sup> / <sub>4</sub> " W x 2" D



\*\*Not for sale outside US

### Ballenger Swivel Knife

Catalog #	Description
CP622-4	3.0mm, Bayonet, 199mm (7¾")



### Fredrich Sickle Knife

Catalog #	Description
MCEN44	3.0 x 8.8mm, 180mm (7")



### Apfelbaum Monopolar Suction Tube

Working length 65mm (2½")

Catalog #	Description
MCEN730	1.9mm O.D., Angled 20°



### Freche Monopolar Knife

Catalog #	Description
MCEN101	0.65mm Blade, Right Angle, 75mm (3")
MCEN105	2.55 x 10.0mm, Angled 125°, 150mm (5⅞")



MCEN105

### Freche Monopolar Suction Tube

Working length 141mm (5½")

Catalog #	Description
MCEN100-2-0*	2.0mm Diameter
MCEN100-2-5*	2.5mm Diameter
MCEN100-3-0*	3.0mm Diameter
MCEN100-3-5*	3.5mm Diameter
CP391	Monopolar Cable, 185cm (6'-8")



MCEN100-2-5

\*Not for sale in US

### Herman Monopolar Hook

Catalog #	Description
MCEN128	0.8 x 2.5mm, Angled 90°, 125mm (4⅞")



### Monopolar Suction Tube

Catalog #	Description
7884	6.6mm Tip, 218mm (8½")

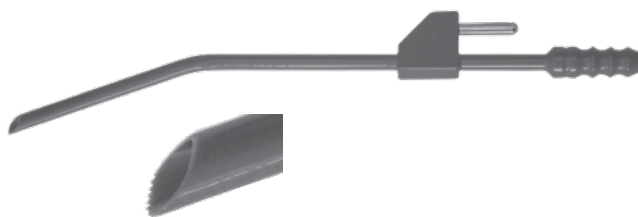

### Rouvier Monopolar Knife

Working length 110mm (4¾")

Catalog #	Description
MCEN11	0.5 x 0.5mm Tip



### Rouvier Monopolar Knife, W/Suction

Catalog #	Description
MCEN102	8.4mm Blade, 111mm (4¾")





**OSTIUM SEEKERS**

**Frontal Ostium Seeker**

Overall length 185mm (7¾"), Double-Ended



Catalog #	Description
MCEN713	2.3mm Ball Tip, 90° to Shaft

**Parsons Maxillary Seeker**

Overall length 190mm (7½")

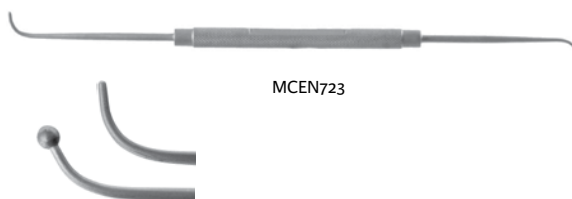

Catalog #	Description
MCEN720	Hockey Stick Seeker, Sharp, D/E, 185mm (7¼")
MCEN721	Uncinate Seeker, Angled, D/E, 195mm (7¾")
MCEN723	Maxillary Seeker, Angled, D/E, 190mm (7½")

**RASPS**

**Joseph Rasp**

Overall length 185mm (7¼")



Catalog #	Description
CP310	5.0 x 24.0mm, Light Curve
CP310D	5.0 x 24.0mm, Straight
CP310E	4.0 x 24.0mm, Light Curve

**Obwegeser Raspatory**

Catalog #	Description
CP344B	6.7mm, Light Curve, 177mm (7")



**RETRACTORS**

**Dautrey Retractor**

Overall length 135mm (5⅜")

Catalog #	Description
CP984	Small
CP984-1	Large



### Dessi Scissors, W/Cleaning Port

Catalog #	Description
MCEN41D3	11.0mm Blades, Straight, 105mm (4 1/8")

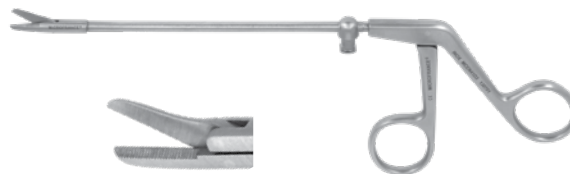

### Faure Sinus Scissors

Catalog #	Description
CEP20	16.0mm Blades, Straight, 108mm (4 1/4")



### Jankowski Sinus Scissors, W/Cleaning Port

Catalog #	Description
MCEN41J	16.2mm Blades, Straight, 110mm (4 3/8")
MCEN42J	21.0mm Blades, Curved Left, 110mm (4 3/8")
MCEN42J1	21.0mm Blades, Curved Right, 110mm (4 3/8")

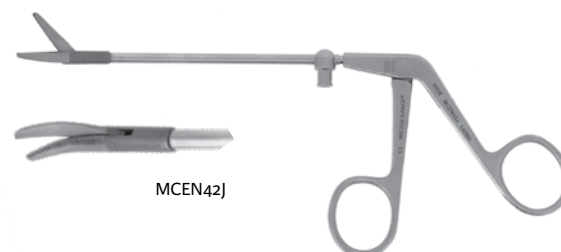

### Peynegre Scissors

Working length 100mm (3 7/8")

Catalog #	Description
MCEN41-1	11.0mm, Straight



### Rouvier Scissors

Overall length 100mm (3 7/8")

Catalog #	Description
MCEN42	10.0mm, Serrated, Curved Left
MCEN42-1	10.0mm, Serrated, Curved Right



### Beckman Speculum

Catalog #	Description
7899	32.0mm, 159mm (6¼")



### Cottle Specula

Catalog #	Description
CP949-45	45.0mm, 145mm (5¾")
CP949-55	55.0mm, 150mm (5⅞")
CP949-75	75.0mm, 160mm (6¾")



CP949-55

### Hartmann Speculum

Catalog #	Description
7898	32.0mm, 159mm (6¼")



### Killian Nasal Specula

Catalog #	Description
CP624-45	45.0mm Blades, 143mm (5⅝")
CP624-55	55.0mm Blades, 147mm (5¾")
CP624-65	65.0mm Blades, 150mm (5⅞")
CP624-75	75.0mm Blades, 151mm (5⅞")



CP624-55

### Killian Nasal Speculum, W/Fiberoptics

Catalog #	Description
CP624LF-75	16.6 x 75.0mm Blades, 164mm (6½")



### Nasal Speculum

Catalog #	Description
MCO237	28.0mm, Serrated Blades, 138mm (5 <sup>3</sup> / <sub>8</sub> "



### Rouvier Speculum

Catalog #	Description
MCEN2	75.0mm Serrated Blades, 130mm (5 <sup>1</sup> / <sub>8</sub> "



### Tieck-Halle Speculum

Catalog #	Description
7897*	31.0mm, 130mm (5 <sup>1</sup> / <sub>8</sub> "



\*Not for sale in US

### Vacher Nasal Specula

Catalog #	Description
7746A*	Child Size
7746B*	Adult Size



7746A



7746B

\*Not for sale in US

### Vienna Nasal Speculum

Catalog #	Description
MCO233*	28.0mm, 134mm (5 <sup>1</sup> / <sub>4</sub> "



\*Not for sale in US

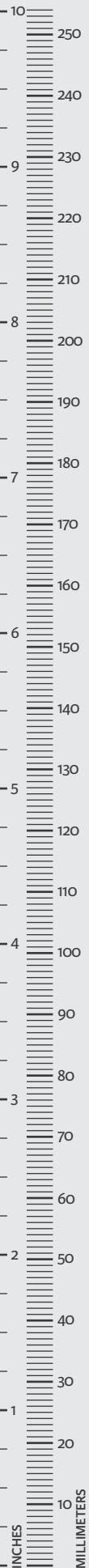

### Claoue Suction Tube and Probe

Catalog #	Description
MCEN58	2.5mm O.D., 96mm (3¾")



### Frazier Suction Irrigation System

Catalog #	Description
1375011	Essar Replacement Valve
1375012	Essar Universal Handle (includes valve)

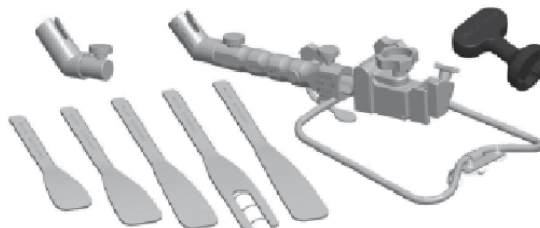

Catalog #	Suction	Irrigation	Working Length
<i>Without Relief Hole:</i>			
1375020	10 French	7 French	10 cm
<i>With Relief Hole:</i>			
1375025	10 French	10 French	10 cm
1375101	5 French	4 French	9 cm
1375102	4 French	4 French	9 cm
1375103	4 French	3 French	9 cm
1375107	7 French	7 French	9 cm
1375110	10 French	7 French	9 cm
1375114	14 French	7 French	9 cm
1375201	5 French	4 French	12 cm
1375207	7 French	7 French	12 cm
1375210	10 French	7 French	12 cm
1375214	15 French	7 French	12 cm

### Faure Suction Tube

Catalog #	Description
CEP30	3.0mm O.D., 125mm (4⅞")



### Guillen Suction Tube-Elevator

Overall length 200mm (7¾"), Bayonet

Catalog #	Description
CP337-1	6.2mm Tip



### Jankowski Suction Tube

Catalog #	Description
MCEN770J30	3.0mm O.D., Angled 140°, 119mm (4⅝")
MCEN770J40	4.0mm O.D., Angled 140°, 123mm (4⅞")



MCEN770J40

### Jankowski Suction Tube, W/Bulbus Tip

Catalog #	Description
MCEN78J30	4.0mm O.D., Angled 120°, 94mm (3¾")
MCEN78J40	5.0mm O. D., Angled 120°, 94mm (3¾")
MCEN79J25	3.5mm O.D., Angled 130°, 91mm (3⅝")
MCEN79J30	4.0mm O.D., Angled 130°, 93mm (3⅝")
MCEN79J40	5.0mm O.D., Angled 130°, 93mm (3⅝")



MCEN78J40

### Orsel Suction Elevator

Working length 85mm (3⅜")

Catalog #	Description
MCEN39	3.0mm Diameter



### Orsel Suction Irrigation Cannula

Catalog #	Description
MCEN187	8.0mm , Angled 165°, 117mm (4⅝")



### Suction Tube-Elevator, Rotatable

Overall length 200mm (7¾"), Bayonet

Catalog #	Description
SCP337A	4.3mm Tip



### Suction Cannula

Overall Length 163mm (6½")

Catalog #	Description
7722-3	3.5mm, Curved Tip



### Suction Irrigation Cannula

Catalog #	Description
MCEN183	3.0mm O.D., Angled 130°, 117mm (4⅝")
MCEN184	2.5mm O.D., Angled 125°, 117mm (4⅝")
MCEN186	2.5mm O.D., Straight, 116mm (4⅝")



MCEN183

### Suction Tube

Working length 110mm (4<sup>3</sup>/<sub>8</sub>"

Catalog #	Description
CP330-3-0	3.0mm O.D., 155° Angle
CP330-4-0	4.0mm O.D., 155° Angle



CP330-4-0

### Suction Tube Elevator

Working Length 125mm (4<sup>7</sup>/<sub>8</sub>" ), Malleable

Catalog #	Description
CP337	4.4mm Tip



### Suction Tube, Angled

Catalog #	Description
MCEN23-2-5	2.5mm O. D., Angled 150°, 160mm (6 <sup>1</sup> / <sub>4</sub> " )
MCEN23-3-0	3.0mm O. D., Angled 150°, 157mm (6 <sup>1</sup> / <sub>4</sub> " )



MCEN23-3-0

### Suction Tube, Blunt, Malleable

Working Length 115mm (4<sup>1</sup>/<sub>2</sub>" )

Catalog #	Description
MCEN37-1-20	3.0mm O.D.
MCEN37-1-25	3.5mm O.D.
MCEN37-1-30	4.0mm O.D.
MCEN371D35	4.5mm O.D.
MCEN371D4	5.0mm O.D.



MCEN37-1-30

### Suction Tube, Blunt, Malleable

Catalog #	Description
MCEN37-2-0	3.0mm O.D., Angled 130°, 100mm (3 <sup>7</sup> / <sub>8</sub> " )
MCEN37-2-5	3.5mm O.D., Angled 130°, 102mm (4" )
MCEN37-3-0	4.0mm O.D., Angled 130°, 104mm (4 <sup>1</sup> / <sub>8</sub> " )
MCEN37-3-5	4.5mm O.D., Angled 130°, 102mm (4" )
MCEN37D4	5.1mm O.D., Angled 130°, 100mm (3 <sup>7</sup> / <sub>8</sub> " )

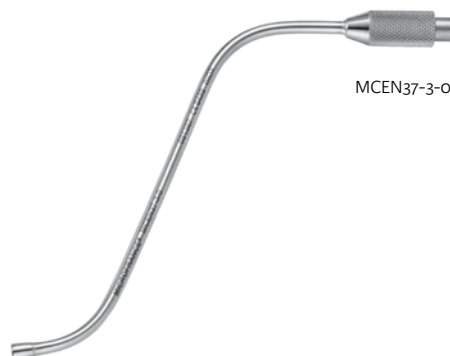

MCEN37-3-0

### Suction Tube, W/Bulbus Tip

Catalog #	Description
MCEN770B25	3.5mm O.D., Angled 130°, 109mm (4 1/4")
MCEN770B30	4.0mm O.D., Angled 130°, 115mm (4 1/2")



MCEN770B25

### Suction Tube, W/Bulbus Tip

Catalog #	Description
MCEN77-3-0	4.0mm O.D., Angled 135°, 111mm (4 3/8")
MCEN77-3-5	4.5mm O.D., Angled 135°, 112mm (4 3/8")



MCEN77-3-5

### De Gabory Suction Tube Handle

Catalog #	Description
MCEN103LDG	8.0mm, For Suction Irrigation





**Comeg**

---

**Comeg Telescope Sleeve, 0°, W/Cleaning Port**

Catalog #	Description
MCEN83-C*	Sleeve, 5.0mm O.D., 182.5mm (7¼") Irrigation Cannula, 1.5mm O.D., 183.8mm (7¼")



\*Not for sale in US

---

**Comeg Telescope Sleeve, 30°, W/Cleaning Port**

Catalog #	Description
MCEN81-C	Sleeve, 5.0mm O.D., 184mm (7¼") Irrigation Cannula, 1.5mm O.D., 181.6mm (7¼")



**Comeg Telescope Sleeve, 45°, W/Cleaning Port**

Catalog #	Description
MCEN87C*	Sleeve, 5.0mm O.D., 184mm (7¼") Irrigation Cannula, 1.5mm O.D., 181.3mm (7¼")



\*Not for sale in US

---

**Comeg Telescope Sleeve, 70°, W/Cleaning Port**

Catalog #	Description
MCEN82-C*	Sleeve, 5.0mm O.D., 183.3mm (7¼") Irrigation Cannula, 1.5mm O.D., 183.3mm (7¼")



\*Not for sale in US

## Olympus

### Olympus Fiberoptic Light Source Adapter

Catalog #	Description
MCL197	Fiberoptic Light Source Adapter



### Olympus Telescope Sleeve, 0°, W/Cleaning Port

Catalog #	Description
MCEN830*	Sleeve, 5.0mm O.D., 167.3mm (6½") Irrigation Cannula, 1.5mm O.D., 167.5mm (6½")

\*Not for sale in US



### Olympus Telescope Sleeve, 0°, W/Cleaning Port

Catalog #	Description
MCEN830L*	Sleeve, 5.0mm O.D., 156mm (6¼") Irrigation Cannula, 1.5mm O.D., 156mm (6¼")

\*Not for sale in US



### Olympus Telescope Sleeve, 30°, W/Cleaning Port

Catalog #	Description
MCEN810	Sleeve, 5.0mm O.D. , 168.5mm (6¾") Irrigation Cannula, 1.5mm O.D., 166mm (6½")



### Olympus Telescope Sleeve, 30°, W/Cleaning Port

Catalog #	Description
MCEN8101	Sleeve, 5.0mm O.D., 155mm (6") Irrigation Cannula, 1.5mm O.D. , 153mm (6")



### Olympus Telescope Sleeve, 30°, W/Cleaning Port

**Catalog #    Description**

**MCEN81O2\*** Sleeve, 5.0mm O.D., 155.6mm (6")  
Irrigation Cannula, 1.5mm O.D., 153.7mm (6")



\*Not for sale in US

### Olympus Telescope Sleeve, 45°, W/Cleaning Port

**Catalog #    Description**

**MCEN87O3\*** Sleeve, 5.0mm O.D., 155.7mm (6")  
Irrigation Cannula, 1.5mm O.D., 152mm (6")



\*Not for sale in US

### Olympus Telescope Sleeve, 45°, W/Cleaning Port

**Catalog #    Description**

**MCEN87O4\*** Sleeve, 5.0mm O.D., 155.7mm (6")  
Irrigation Cannula, 1.5mm O.D., 152mm (6")



\*Not for sale in US

### Olympus Telescope Sleeve, 70°, W/Cleaning Port

**Catalog #    Description**

**MCEN82O\*** Sleeve, 5.0mm O.D., 170mm (6 3/4")  
Irrigation Cannula, 1.5mm O.D., 164.4mm (6 1/2")



\*Not for sale in US

### Olympus Telescope Sleeve, 70°, W/Cleaning Port

**Catalog #    Description**

**MCEN82O5\*** Sleeve, 5.0mm O.D., 155.4mm (6")  
Irrigation Cannula, 1.5mm O.D., 150.2mm (5 7/8")



\*Not for sale in US

### Olympus Telescope Sleeve, 70°, W/Cleaning Port

**Catalog #    Description**

**MCEN82O6\*** Sleeve, 5.0mm O.D., 155.4mm (6 1/8")  
Irrigation Cannula, 1.5mm O.D., 150.4mm (5 7/8")



\*Not for sale in US

**Storz**

**Storz Fiberoptic Adapter**

Catalog #	Description
MCL174	Fiberoptic Adapter

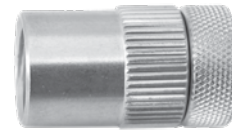

**Storz Telescope Adapter**

Catalog #	Description
MCL75	11.9mm O.D., 22.0mm



**Storz Telescope Sleeve, 0°, W/Cleaning Port**

Catalog #	Description
MCEN83-S*	Sleeve, 5.0mm O.D., 183.6mm (7¼") Irrigation Cannula, 1.5mm O.D., 184mm (7¼")

\*Not for sale in US



**Storz Telescope Sleeve, 30°, W/Cleaning Port**

Catalog #	Description
MCEN81-S*	Sleeve, 5.0mm O.D., 183.6mm (7¼") Irrigation Cannula, 1.5mm O.D., 181.6mm (7¼")

\*Not for sale in US



**Storz Telescope Sleeve, 45°, W/Cleaning Port**

Catalog #	Description
MCEN87-S*	Sleeve, 5.0mm O.D., 183.4mm (7¼") Irrigation Cannula, 1.5mm O.D., 179.8mm (7")

\*Not for sale in US



### Storz Telescope Sleeve, 70°, W/Cleaning Port

Catalog #	Description
MCEN82-S*	Sleeve, 5.0mm O.D., 184mm (7¼") Irrigation Cannula, 1.5mm O.D., 178.5mm (7")

\*Not for sale in US



### Storz Fiberoptic Light Source Adapter

Catalog #	Description
MCL173	Fiberoptic Light Source Adapter

### Wolf

### Wolf Fiberoptic Light Source Adapter

Catalog #	Description
MCL170	Fiberoptic Light Source Adapter



### Wolf Telescope Adapter

Catalog #	Description
MCL171	11.9mm O.D., 22mm

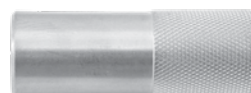

### Wolf Telescope Sleeve, 0°, W/Cleaning Port

Catalog #	Description
MCEN83-W*	Sleeve, 5.0mm O.D., 179mm (7") Irrigation Cannula, 1.5mm O.D., 180mm (7")

\*Not for sale in US



### Wolf Telescope Sleeve, 30°, W/Cleaning Port

Catalog #	Description
MCEN81-W*	Sleeve, 5.0mm O.D., 179.7mm (7") Irrigation Cannula, 1.5mm O.D., 178mm (7")

\*Not for sale in US



### Wolf Telescope Sleeve, 45°, W/Cleaning Port

Catalog #	Description
MCEN87W*	Sleeve, 5.0mm O.D., 181.4mm (7 <sup>1</sup> / <sub>4</sub> " Irrigation Cannula, 1.5mm O.D., 177.3mm (7")

\*Not for sale in US



### Wolf Telescope Sleeve, 70°, W/Cleaning Port

Catalog #	Description
MCEN82-W*	Sleeve, 5.0mm O.D., 186mm (7 <sup>1</sup> / <sub>4</sub> " Irrigation Cannula, 1.5mm O.D., 178mm (7 <sup>1</sup> / <sub>8</sub> "

\*Not for sale in US



### Telescope Sleeve, W/Cleaning Port

Catalog #	Description
MCEN88A*	Sleeve, 5.0mm O.D. x 183mm (7 <sup>1</sup> / <sub>4</sub> " Irrigation Cannula, 1.5mm O.D. x 179mm (7")

\*Not for sale in US

### Telescope Sleeve, W/Cleaning Port

Catalog #	Description
MCEN88SC*	Sleeve, 5.0mm O.D., 183mm (7 <sup>1</sup> / <sub>4</sub> " Irrigation Cannula, 1.5mm O.D., 179mm (7")

\*Not for sale in US

### Telescope Support Forceps

Catalog #	Description
MCEN88P*	39.0mm x 94.0mm x 5.0mm

\*Not for sale in US



### Cleaning Adapter

Catalog #	Description
MCEN39L	12.0mm O.D., 38mm (1½"), 3/Pkg

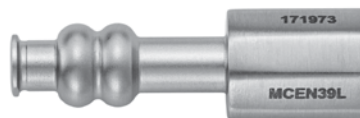

### Dessi Suction Irrigation Pump

Catalog #	Description
MCEN80*	Suction Irrigation Pump

\*Not for sale in US



### Suction Irrigation Tube

Catalog #	Description
MCEN84S*	Suction Irrigation Tube 20/Pkg.

\*Not for sale in US



### Rouvier Sinus Trocar and Sleeve

Catalog #	Description
MCEN25-4-0	Cannula, 106mm, (4½") Trocar, 194mm, (7¾')

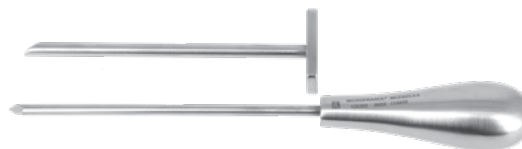

### Sinus Probe

Catalog #	Description
7731	1.4mm, Angled Handle, 106mm (4½")



### Legent Flexible Tension Arm

The MicroFrance® Legent Flexible Tension Arm can be used for a variety of procedures including otology, neurotology, and sinus procedures. The flexible arm attaches to the operating room table and holds a variety of instrumentation so that both hands can be free for operation. Included with the flexible arm are the ear speculum forceps, malleable retractor blade, and nasal speculum connection. An adjustable endoscope holder is also available to support a rigid telescope. The angulated ball joint can be used with any of the attachments to facilitate positioning of the instrument during surgery.

### Legent Flexible Tension Arm

Catalog #	Description
MCO980	Flexible Tension Arm 450mm (17¾")
MCO981	Ear Speculum Forceps
MCO982	Nasal Speculum Connection
MCO983	Malleable Blade Retractor, 12.0 x 86.0mm

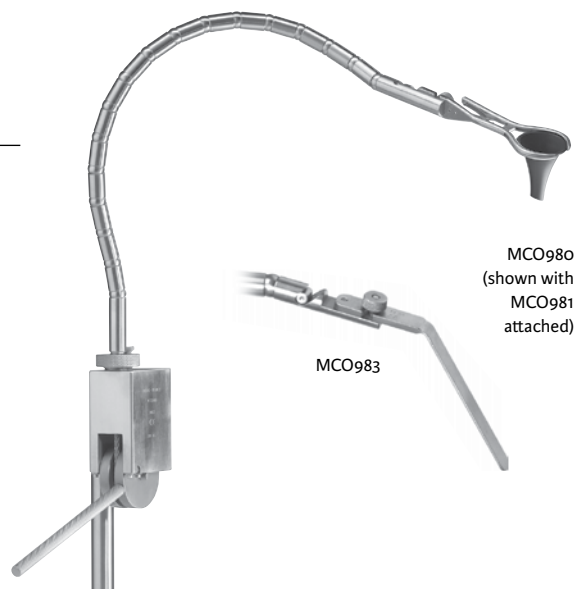

### Legent Flexible Tension Arm Accessories

Catalog #	Description
CEV980-3	Endoscope Holder (Fits Rigid Telescopes 4-10mm)
MCO983-4	Angulated Ball Joint for MCO980
CEV984	Operating Table Clamp Devéze Self-Retaining Speculum

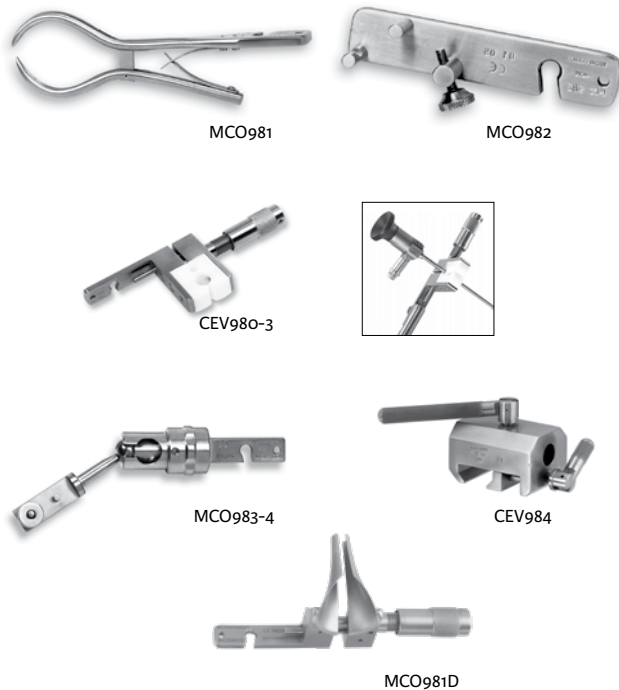





# Integra<sup>®</sup> MicroFrance<sup>®</sup>

## Indices

0-28-1 .....	291	1422300 .....	138	242-5-0 .....	247
0-28-2 .....	291	1422400 .....	138	242-6-0 .....	247
0-28-3 .....	291	1423000 .....	120	242-7-0 .....	247
0-28-4 .....	291	1423002 .....	120	3711002 .....	76, 308
0-28-7 .....	291	1423004 .....	120	3711004 .....	76
0-28-8 .....	291	1458230 .....	18	3711005 .....	76
0-28 .....	291	1458231 .....	18	3711006 .....	76
1003IG .....	292	1458232 .....	18	3711007 .....	74
1003LI .....	292	1458233 .....	18	3711008 .....	79
1004IG .....	292	1458234 .....	18	3711009 .....	77
1005I .....	292	1458275 .....	18	3711010 .....	74
1316005 .....	58	1458276 .....	18	3711011 .....	74
1352020 .....	31	164RS-1-8 .....	248	3711012 .....	74
1352247 .....	21, 259	1650025 .....	139	3711013 .....	74
1352248 .....	21, 259	1650030 .....	139, 224	3711014 .....	79
1352277 .....	30	168RS .....	248	3711017 .....	78
1352282 .....	30	1886100 .....	140	3711018 .....	78
1352285 .....	31	1886200 .....	140	3711019 .....	78
1352286 .....	31	1886300 .....	140	3711020 .....	78
1352287 .....	31	2035512C4 .....	248	3711021 .....	78, 308
1352321 .....	18	2035515C4 .....	248	3711022 .....	75
1352325 .....	18	236HM-0-6 .....	247	3711025 .....	75
1352431 .....	94	236HM-0-8 .....	247	3711026 .....	75
1358270 .....	32	236HM-1-0 .....	247	3711027 .....	75
1359254 .....	32	236HM-1-4 .....	247	3711028 .....	71
1359256 .....	32	236HM-1-8 .....	247	3711029 .....	78
1359258 .....	32	236HM-2-3 .....	247	3711032 .....	89
1359260 .....	32	236HM-2-7 .....	247	3711034 .....	89
1359262 .....	32	236HM-3-0 .....	247	3711035 .....	77
1359264 .....	32	236HM-3-5 .....	247	3711036 .....	77
1362275 .....	30	236HM-4-0 .....	247	3711037 .....	77
1362279 .....	30	236HM-4-5 .....	247	3711038 .....	79
1375011 .....	373	236HM-5-0 .....	247	3711039 .....	79
1375012 .....	373	236HM-7-0 .....	247	3711040 .....	79
1375020 .....	373	236RS-1-4 .....	246	3711041 .....	79
1375025 .....	373	236RS-1-8 .....	246	3711042 .....	79
1375101 .....	373	236RS-2-3 .....	246	3711043 .....	79
1375102 .....	373	236RS-3-1 .....	246	3711044 .....	79
1375103 .....	373	236RS-3-5 .....	246	3711045 .....	79
1375107 .....	373	236RS-4-0 .....	246	3711046 .....	80
1375110 .....	373	236RS-4-5 .....	246	3711047 .....	80
1375114 .....	373	236RS-5-0 .....	246	3711048 .....	80
1375201 .....	373	236RS-6-0 .....	246	3711049 .....	71
1375207 .....	373	236RS-7-0 .....	246	3711050 .....	71
1375210 .....	373	242-0-6 .....	247	3711051 .....	71
1375214 .....	373	242-0-7 .....	247	3711052 .....	71
1411000 .....	19	242-0-8 .....	247	3711053 .....	71
1411050 .....	19	242-1-0 .....	247	3711054 .....	71
141P23 .....	246	242-1-4 .....	247	3711055 .....	71
141P27 .....	246	242-1-8 .....	247	3711056 .....	71
141P31 .....	246	242-2-3 .....	247	3711057 .....	76
141RS-3-1 .....	246	242-2-7 .....	247	3711059 .....	71
141RS-4-0 .....	246	242-3-1 .....	247	3711060 .....	73
141RS-5-0 .....	246	242-3-5 .....	247	3711061 .....	73
1422100 .....	138	242-4-0 .....	247	3711062 .....	73
1422200 .....	138	242-4-5 .....	247	3711063 .....	73

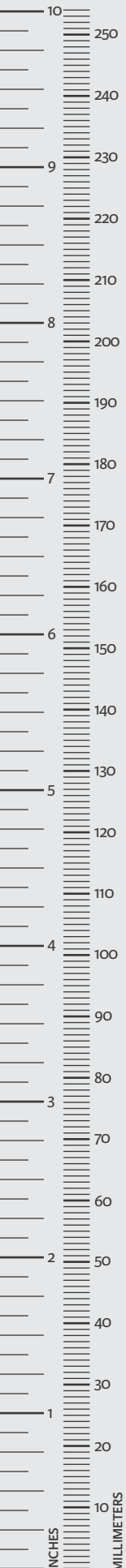

3711064.....	73	3711204.....	80	3712313.....	73
3711065.....	73	3711205.....	80	3712314.....	73
3711066.....	75	3711210.....	80	3712315.....	73
3711067.....	72	3711213.....	80	3713000.....	107
3711068.....	76	3712002.....	24, 105	3713001.....	108, 259
3711069.....	76	3712003.....	24, 105	3713002.....	106
3711071.....	75	3712008.....	23, 103	3713003.....	109
3711072.....	82	3712009.....	105	3713004.....	109
3711073.....	82	3712010.....	105	3713005.....	109, 309
3711074.....	82	3712012.....	96	3713006.....	109
3711075.....	82	3712013.....	95	3713009.....	111
3711076.....	82	3712014.....	95	3713010.....	111
3711077.....	82	3712015.....	23, 104	3713012.....	111
3711078.....	82	3712016.....	23, 104	3713013.....	110, 309
3711079.....	72	3712017.....	23, 104	3713014.....	110, 309
3711080.....	72	3712021.....	104	3713015.....	109, 156
3711081.....	72	3712022.....	96	3713016.....	109, 156
3711082.....	73	3712023.....	94	3713018.....	109
3711083.....	73	3712024.....	94	3713020.....	106
3711084.....	72	3712025.....	96	3713022.....	108
3711085.....	72	3712026.....	97	3713023.....	107
3711086.....	72	3712027.....	97	3713024.....	108
3711088.....	73	3712028.....	94	3713025.....	108
3711089.....	73	3712029.....	94	3713026.....	110
3711099.....	138	3712030.....	97	3713027.....	110
3711100.....	74	3712031.....	97	3713028.....	110
3711102.....	80	3712032.....	97	3713029.....	110
3711103.....	80	3712033.....	97	3713030.....	110
3711105.....	79	3712034.....	97	3713031.....	110
3711108.....	71	3712035.....	97	3713032.....	107
3711109.....	78	3712036.....	97	3713054.....	109
3711110.....	72	3712037.....	97	3713055.....	109
3711113.....	77	3712038.....	95	3713056.....	108
3711114.....	77	3712039.....	95	3713058.....	110
3711115.....	77	3712040.....	95	3713059.....	107
3711116.....	81	3712042.....	95	3713060.....	106
3711117.....	81	3712043.....	96	3713061.....	106
3711118.....	79	3712044.....	96	3713063.....	106
3711119.....	79	3712107.....	97	3714000.....	34, 116
3711121.....	81	3712108.....	97	3714000S.....	33, 34, 115, 116
3711124.....	81	3712116.....	97	3714001.....	34, 116, 309
3711127.....	77	3712117.....	97	3714002.....	34, 116
3711128.....	77	3712118.....	95	3714003.....	34, 116
3711129.....	71	3712119.....	95	3714004.....	34, 116, 309
3711130.....	71	3712124.....	95	3714005.....	34, 116
3711137.....	82	3712200.....	23, 104	3714006.....	34, 116
3711140.....	72	3712201.....	23, 104	3714007.....	34, 116
3711141.....	72	3712210.....	24, 105	3714008.....	64
3711142.....	81	3712211.....	24, 105	3714009.....	64
3711143.....	81	3712212.....	105	3714010.....	64
3711145.....	81	3712219.....	105	3714011.....	64
3711146.....	81	3712300.....	73	3714016.....	102
3711200.....	80	3712301.....	73	3714017.....	101
3711201.....	80	3712310.....	73	3714018.....	100
3711202.....	80	3712311.....	73	3714019.....	84, 258
3711203.....	80	3712312.....	73	3714020.....	84, 309

3714021.....	84, 308	3714098.....	92	3714199.....	114
3714022.....	84	3714099.....	92	3714200.....	114
3714023.....	84, 308	3714100.....	90	3714201.....	114, 309
3714024.....	85	3714101.....	90	3714202.....	114
3714025.....	85	3714102.....	90	3714203.....	114
3714026.....	85	3714104.....	88	3714204.....	112
3714027.....	102	3714105.....	88	3714205.....	113
3714028.....	102	3714106.....	83	3714206.....	113, 309
3714029.....	102	3714107.....	83	3714207.....	113
3714031.....	103	3714108.....	83	3714208.....	113
3714032.....	103	3714109.....	83	3714209.....	112
3714033.....	103	3714110.....	83, 308	3714210.....	112
3714034.....	89	3714111.....	85	3714211.....	112
3714035.....	89	3714113.....	83	3714212.....	112
3714038.....	68, 308	3714114.....	69	3714213.....	112
3714039.....	68	3714115.....	69	3714214.....	112
3714040.....	70	3714116.....	69	3714215.....	112
3714043.....	84	3714117.....	70	3714218.....	117
3714044.....	84	3714118.....	68	3714219.....	117
3714045.....	84, 308	3714119.....	70	3714220.....	117
3714049.....	35, 116	3714121.....	70	3714221.....	66
3714050.....	35, 116	3714123.....	70	3714222.....	66
3714053.....	65	3714125.....	69, 308	3714223.....	66
3714055.....	65	3714126.....	68	3714224.....	66
3714056.....	65	3714127.....	68, 308	3714225.....	66
3714057.....	65	3714148.....	98, 309	3714226.....	66
3714058.....	65	3714149.....	98, 309	3714227.....	67
3714059.....	91, 309	3714150.....	99	3714228.....	67
3714060.....	91, 309	3714151.....	99	3714229.....	67
3714062.....	91	3714152.....	99	3714230.....	67
3714063.....	91, 309	3714153.....	99	3714231.....	93
3714064.....	91	3714162.....	87	3714232.....	93
3714065.....	91	3714163.....	86	3714233.....	94
3714066.....	91	3714164.....	86	3714237.....	116
3714067.....	91	3714165.....	86	3714238.....	116
3714068.....	91	3714166.....	86	3714239.....	116
3714070.....	91	3714167.....	86	3714240.....	116
3714071.....	91	3714168.....	86	3714241.....	117
3714072.....	91	3714169.....	86	3714242.....	117
3714073.....	91	3714171.....	87	3714243.....	117
3714074.....	91	3714172.....	87	3714244.....	87
3714075.....	92	3714173.....	86	3714245.....	87
3714076.....	92, 309	3714178.....	100	3714246.....	87
3714077.....	92, 309	3714179.....	101, 309	3714247.....	90
3714078.....	93	3714180.....	101	3714249.....	90
3714086.....	65	3714181.....	102	3714250.....	33, 115
3714087.....	65	3714182.....	101	3714251.....	33, 115
3714088.....	65	3714183.....	101	3714252.....	33, 115
3714090.....	93	3714184.....	100	3714253.....	33, 115
3714091.....	93	3714187.....	101	3714254.....	33, 115
3714092.....	93	3714192.....	100	3714255.....	33, 115
3714093.....	93	3714193.....	100	3714256.....	33, 115
3714094.....	90	3714194.....	111	3714257.....	33, 115
3714095.....	90	3714195.....	111	3714258.....	33, 115
3714096.....	91	3714197.....	111	3714259.....	33, 115
3714097.....	92	3714198.....	111	3714260.....	33, 115

3714261	33, 115	3714479	115	3721014	9, 259
3714262	33, 115	3714480	113	3721015	15
3714263	33, 115	3714481	113	3721016	14
3714264	33, 115	3714482	113	3721018	12
3714265	33, 115	3714483	113	3721020	13
3714266	85	3714490	117	3721021	12
3714282	87	3714491	117	3721022	12
3714284	67	3714494	116	3721023	9
3714285	67	3714495	116	3721024	9
3714311	67	3714600	93	3721025	9, 259
3714313	67	3714651	84	3721026	13, 37
3714314	67	3714660	68	3721027	13
3714315	67	3714667	98	3721028	9
3714316	67	3714672	98	3721029	11
3714317	67	3714673	87	3721030	11
3714320	65	3714674	87	3721032	11
3714321	92	3714678	87	3721036	9
3714322	92	3714681	103, 309	3721037	13
3714323	92	3714684	101	3721038	13
3714324	92	3714685	111	3721039	13
3714325	92	3714687	112	3721040	13
3714326	92	3714688	113	3721041	10
3714327	92	3714690	112	3721042	10
3714329	92	3714691	112	3721043	10
3714330	92	3714692	112	3721044	10
3714331	92	3714696	117	3721045	26
3714332	92	3714703	67	3721046	26
3714333	92	3714780	259	3721059	16
3714334	92	3714781	259	3721060	16
3714335	92	3714782	259	3722000	38
3714338	91	3714783	259	3722001	38
3714350	88	3717000	118, 168	3722002	38
3714351	88	3717001	118, 169	3722003	38
3714352	89	3717002	118, 167, 212, 338, 340, 343	3722004	39
3714353	88, 309	3717006	118, 168	3722005	39
3714364	83	3717008	308	3722006	39
3714365	83	3717010	341	3722008	39
3714372	68	3717011	60, 169, 309	3722009	39
3714379	69	3717012	118, 167, 208, 209, 264	3722010	39
3714381	68	3717022	61, 169, 252, 262, 264	3722011	39
3714382	69	3717023	140, 170, 223	3722012	39
3714383	69	3717025	60, 170	3722013	39
3714401	99	3717026	60, 170, 260	3722014	40
3714402	99	3718010	86	3722015	40
3714432	86	3718020	86	3722016	40
3714433	86	3721000	11	3722020	40, 258, 263
3714438	87	3721001	15	3722021	40
3714450	100	3721002	14	3722022	40
3714451	103	3721004	10	3722023	40
3714452	103	3721005	15	3722024	40
3714471	114	3721006	12	3722025	160
3714472	112, 309	3721007	12	3722026	41
3714475	114	3721008	14	3722027	41
3714476	114	3721009	14, 259	3722028	41
3714477	114	3721012	12	3722029	41
3714478	115	3721013	12	3722030	41

3722031.....	42	3722091.....	49	3724005.....	6
3722032.....	42	3722092.....	49	3724006.....	6
3722033.....	42	3722093.....	49	3724007.....	6
3722034.....	42	3722100.....	50	3724009.....	6
3722035.....	42	3722101.....	50	3724011.....	6
3722036.....	46, 263	3722102.....	50	3724012.....	6
3722037.....	44, 258, 263	3722103.....	43	3724013.....	6, 37, 258
3722038.....	46, 258	3722106.....	51	3724014.....	6
3722039.....	46	3722107.....	51	3724015.....	6
3722040.....	47, 258	3722109.....	50	3724016.....	6
3722041.....	44	3722110.....	51	3724017.....	6
3722042.....	44, 258	3722111.....	51	3724018.....	6
3722043.....	45	3722112.....	51	3724019.....	6
3722046.....	46, 259	3722113.....	51, 263	3724020.....	6
3722047.....	46, 259	3722114.....	51, 263	3724022.....	7
3722048.....	44, 259, 263	3722115.....	50, 259	3724023.....	7
3722049.....	43	3722117.....	52, 258	3724024.....	7
3722050.....	43	3722118.....	52	3724026.....	17
3722051.....	43	3722122.....	52, 263	3724027.....	17
3722052.....	43	3722123.....	52	3724028.....	17
3722053.....	47	3722124.....	52	3724029.....	17
3722054.....	45	3722125.....	52	3724030.....	17
3722055.....	45, 258	3722126.....	52	3724043.....	7
3722056.....	45, 263	3722127.....	52	3724044.....	7
3722057.....	45	3722128.....	53	3724045.....	7
3722058.....	37, 43, 258, 263	3722129.....	53	3724046.....	7
3722059.....	46	3722130.....	53	3724047.....	7
3722060.....	46	3722131.....	53	3724055.....	20, 37
3722061.....	46, 258	3722132.....	53	3724056.....	20
3722062.....	47, 258	3722133.....	53	3724057.....	20
3722063.....	46, 258	3722134.....	53	3724058.....	20, 258
3722064.....	47	3722136.....	56, 263	3724059.....	8
3722065.....	44, 258	3722140.....	54	3724060.....	8, 259
3722066.....	46	3722141.....	54	3724061.....	59, 258
3722067.....	46	3722142.....	54	3724062.....	59
3722068.....	46, 263	3722145.....	55	3724063.....	59
3722069.....	44	3722147.....	55	3724064.....	58
3722070.....	44	3722149.....	57	3724065.....	8
3722071.....	43, 263	3722150.....	57	3724066.....	22, 263
3722072.....	43	3722151.....	57	3724067.....	22, 263
3722073.....	44	3722152.....	57	3724068.....	21
3722075.....	47, 259	3722154.....	56	3724069.....	21
3722076.....	45	3722155.....	56	3724070.....	21
3722077.....	45	3722158.....	56, 263	3724071.....	22
3722078.....	45, 259	3722159.....	56	3724072.....	22
3722079.....	45, 259	3722160.....	54	3724073.....	22
3722080.....	45	3722163.....	57	3724074.....	23, 104
3722082.....	48	3722164.....	20	3724083.....	26, 257
3722083.....	48	3723001.....	25	3724084.....	26, 257
3722084.....	48	3723005.....	25	3724085.....	26, 257
3722085.....	48	3723006.....	25	3724093.....	27
3722086.....	49	3723008.....	25	3724094.....	27
3722087.....	49	3724001.....	6	3724095.....	27
3722088.....	49	3724002.....	6	3724096.....	27
3722089.....	49	3724003.....	6, 258	3724097.....	27
3722090.....	49	3724004.....	6	3724098.....	27



3724099 .....	27	3724184 .....	32	3724284 .....	38
3724100 .....	27	3724185 .....	32	3724285 .....	41
3724101 .....	27	3724186 .....	33	3724287 .....	41
3724102 .....	27	3724187 .....	33	3724289 .....	41
3724103 .....	27	3724188 .....	32	3724290 .....	41
3724104 .....	27	3724189 .....	33	3724291 .....	41
3724105 .....	27	3724190 .....	33	3724292 .....	42
3724106 .....	27	3724191 .....	33	3724293 .....	47
3724107 .....	27	3724193 .....	33	3724294 .....	48
3724108 .....	28, 256	3724194 .....	33	3724296 .....	48
3724109 .....	28, 256	3724196 .....	33	3724305 .....	54
3724110 .....	28, 256	3724199 .....	36	3724307 .....	17, 263
3724111 .....	28, 256	3724200 .....	36	3724309 .....	25
3724112 .....	28, 256	3724201 .....	36	3724310 .....	25
3724113 .....	28, 256	3724203 .....	36	3724311 .....	26
3724114 .....	28, 256	3724205 .....	36	3724312 .....	25
3724122 .....	28	3724206 .....	36	3724316 .....	31
3724123 .....	28	3724207 .....	36	3724318 .....	58
3724124 .....	28	3724209 .....	36	3724320 .....	58
3724125 .....	28	3724210 .....	36	3724332 .....	22
3724126 .....	28	3724211 .....	36	3724333 .....	22
3724127 .....	28	3724213 .....	34	3724370 .....	13
3724128 .....	28	3724214 .....	34, 256	3724376 .....	19
3724138 .....	30	3724215 .....	34, 256	3724395 .....	58
3724140 .....	29	3724216 .....	34, 256	3724397 .....	139
3724141 .....	29, 257	3724217 .....	35	3724400 .....	30
3724142 .....	29, 257	3724218 .....	35, 258	3724401 .....	30, 37
3724143 .....	29, 257	3724219 .....	35, 258	3724402 .....	30
3724144 .....	29, 257	3724220 .....	35, 258	3724403 .....	30, 37
3724145 .....	29	3724221 .....	35, 258	3724404 .....	30
3724146 .....	29	3724222 .....	35, 258	3724405 .....	30, 37
3724147 .....	29	3724223 .....	35, 258	3724406 .....	30
3724148 .....	29	3724224 .....	35, 258	3724407 .....	30
3724149 .....	29	3724225 .....	35, 258	3724408 .....	30
3724150 .....	29	3724226 .....	35, 258	3724409 .....	30
3724151 .....	29	3724231 .....	59	3724410 .....	30
3724152 .....	28	3724232 .....	59	3724411 .....	30
3724153 .....	28	3724233 .....	59	3724420 .....	35
3724154 .....	28	3724234 .....	59	3724421 .....	35
3724155 .....	28	3724235 .....	59	3724422 .....	35
3724157 .....	28	3724240 .....	22	3724450 .....	27
3724158 .....	29	3724241 .....	22	3724470 .....	28
3724159 .....	29	3724242 .....	22	3724490 .....	28
3724160 .....	29	3724243 .....	22	3731000 .....	126
3724161 .....	29	3724244 .....	22	3731001 .....	126
3724162 .....	29	3724245 .....	22	3731002 .....	126
3724163 .....	29	3724247 .....	22	3731003 .....	126
3724172 .....	32, 37, 256	3724252 .....	21	3731004 .....	121
3724173 .....	32, 37, 256	3724256 .....	84	3731006 .....	121
3724175 .....	32, 37, 256	3724265 .....	10	3731007 .....	122
3724177 .....	35, 257	3724266 .....	12	3731010 .....	122
3724178 .....	35, 257	3724269 .....	13	3731011 .....	136
3724179 .....	35	3724279 .....	19	3731013 .....	136
3724181 .....	35	3724281 .....	19	3731017 .....	136
3724182 .....	35	3724282 .....	19, 258	3731020 .....	136
3724183 .....	32	3724283 .....	38	3731022 .....	137

3731023.....	137	3734018.....	120	3734108 .....	130
3731024.....	137	3734038 .....	123	3734109 .....	116, 134, 215
3731025.....	137	3734042.....	123	3734110 .....	116, 134
3731026 .....	137	3734043.....	123	3734111 .....	116, 134
3731030 .....	136	3734045.....	123	3734114 .....	134
3731031 .....	136	3734047 .....	127	3734115.....	134
3731032.....	136	3734048.....	123	3734117.....	134
3731033.....	136	3734049.....	123	3734123 .....	135
3731034.....	136	3734050.....	123	3734124 .....	135
3731035.....	136	3734051.....	123	3734125.....	135
3731036.....	136	3734052.....	123	3734126.....	135
3731037 .....	136	3734053 .....	123	3734131.....	121
3731038.....	135	3734054.....	123	3734132 .....	121
3731039.....	135	3734055.....	123	3734133 .....	121
3731040 .....	135	3734056.....	123	3734134 .....	121
3731041 .....	135	3734057 .....	123	3734147 .....	123
3731042 .....	135	3734058.....	123	3734148 .....	125
3731043.....	135	3734059.....	125	3734149.....	125
3731044 .....	135	3734060 .....	125	3734150.....	125
3731045 .....	135	3734061 .....	125	3734151 .....	125
3731052.....	126	3734062.....	125	3734152 .....	126
3731053.....	126	3734065.....	126	3734153 .....	127
3731054.....	122	3734066.....	126	3734155.....	129
3731055.....	121	3734067 .....	126	3734156.....	129
3731056 .....	122	3734068.....	126	3734157 .....	129
3731057.....	122	3734069.....	124	3734158 .....	129
3731058.....	122	3734070.....	124	3734160 .....	129
3733001 .....	128	3734071.....	124	3734167 .....	130
3733002.....	137	3734072 .....	124	3734168 .....	130
3733003.....	137	3734073 .....	124	3734218 .....	140
3733004.....	137	3734075 .....	124	3734500.....	130, 140, 170
3733005.....	137	3734076 .....	124	3734510.....	130, 140, 170
3733006.....	137	3734077 .....	124	3740000 .....	148, 258
3733007 .....	137	3734078 .....	124	3740002 .....	148
3733008.....	137	3734079 .....	124	3740003.....	148
3733009.....	137	3734080.....	124	3740006 .....	148
3733010 .....	137	3734081 .....	124	3740009 .....	143
3733014.....	135	3734082.....	124	3740012 .....	147
3733015.....	135	3734083.....	125	3740015 .....	147
3733016.....	135	3734084.....	125	3740019 .....	147
3733017 .....	135	3734085.....	125	3740021 .....	145
3733018.....	135	3734086.....	125	3740024.....	145
3733021.....	128	3734087 .....	125	3740025.....	146, 259
3734000 .....	124	3734088.....	125	3740026.....	146
3734001 .....	124	3734089.....	125	3740027 .....	146
3734003.....	120	3734090 .....	125	3740028.....	146, 308
3734004.....	120	3734091 .....	127	3740031 .....	145
3734005.....	120	3734092.....	127	3740036.....	145
3734006 .....	120	3734093.....	127	3740038.....	146
3734007.....	120	3734096.....	128	3740039.....	146, 308
3734008.....	121	3734097 .....	128	3740049 .....	147
3734009 .....	121	3734100 .....	129	3740051 .....	146, 308
3734010 .....	121	3734103.....	129	3740052.....	146
3734011 .....	121	3734104 .....	129	3740053.....	146, 308
3734012 .....	121	3734105.....	128	3740054.....	146
3734013.....	120	3734107.....	130	3740057.....	146



3740067.....	147	3741131.....	155	3755000.....	166
3740068.....	147	3741132.....	155	3755001.....	166
3740069.....	147	3741154.....	152	3755002.....	166
3740071.....	147	3741156.....	161	3755010.....	166
3740072.....	147	3741160.....	157	3755100.....	164
3740074.....	151	3741164.....	309	3755101.....	164, 308
3740075.....	151	3741166.....	155	3755102.....	164, 308
3740076.....	151	3741177.....	153	3755106.....	165
3740077.....	151	3741178.....	153	3755107.....	165
3740078.....	151	3741179.....	153	3755110.....	165
3740079.....	151	3741180.....	154	3755111.....	165
3740086.....	143, 309	3741181.....	154, 259	3755114.....	165
3740090.....	147	3741182.....	154	3755115.....	165
3740108.....	145	3741183.....	154	3755116.....	164
3741001.....	159	3741184.....	154	3755117.....	164
3741002.....	157	3741187.....	157	3755129.....	165
3741003.....	157	3742000.....	148	3755133.....	166
3741007.....	152, 330	3744000.....	149	3755136.....	166
3741008.....	152, 330	3744001.....	151	3755138.....	165
3741010.....	156	3744003.....	150	3755143.....	164
3741011.....	156	3744010.....	149	3755147.....	164
3741015.....	153	3744012.....	151, 309	3755152.....	166
3741016.....	153	3744015.....	150	3755160.....	164
3741017.....	156	3744016.....	150	3755161.....	164
3741019.....	156	3744019.....	150	3755162.....	164
3741020.....	155	3744020.....	150	701T.....	185
3741021.....	155	3744025.....	149	702T.....	184
3741029.....	154	3744026.....	149	703T.....	184
3741032.....	160, 259	3744027.....	151	704T.....	184
3741033.....	160, 309	3744030.....	150	7060000.....	132
3741034.....	160	3744031.....	150	7060111.....	132
3741035.....	160	3744032.....	150	7060112.....	132, 133
3741036.....	160	3744040.....	151	7060113.....	132, 133
3741046.....	157	3747003.....	144	7060114.....	132, 133
3741048.....	155	3747004.....	143	7060115.....	132, 133
3741049.....	155	3747006.....	70	7060116.....	132, 133
3741052.....	152	3747007.....	144	713T.....	161, 187, 329
3741054.....	153	3747008.....	143	714T.....	184
3741057.....	159	3747012.....	143, 153	720T.....	184
3741060.....	159	3747014.....	143, 153	7706MF.....	205
3741065.....	158	3747017.....	143	7717C.....	204
3741066.....	158	3747019.....	143	7718.....	284
3741067.....	158	3747021.....	144	7719-2.....	242
3741068.....	158	3747025.....	144	7721-1.....	281
3741071.....	158	3747031.....	143	7722-3.....	374
3741075.....	158	3747100.....	142	7725.....	283
3741076.....	158, 309	3747101.....	142	7725P1.....	283
3741077.....	158	3747102.....	142	7725P2.....	283
3741079.....	157	3747102.....	142	7725P3.....	283
3741080.....	158	3747104.....	142	7726MF.....	359
3741081.....	158	3750012.....	309	7727.....	359
3741082.....	158	3752008.....	149, 309	7728.....	359
3741083.....	158	3752011.....	149	7731.....	383
3741098.....	152	3753007.....	159	7732-1.....	361
3741099.....	152	3753008.....	159, 259	7733.....	361
3741129.....	157	3754010.....	37	7734.....	361

7742-1 .....	335	7782-1-2.....	328	7828-16 .....	194
7742-2 .....	335	7783-12 .....	190	7828-19 .....	194
7742-3 .....	335	7787-10.....	324	7829-10.....	194
7746A .....	335, 372	7796 .....	201	7829-13.....	194
7746B .....	335, 372	7797-1 .....	201	7829-16.....	194
7749 .....	273, 359	7797-2 .....	201	7829-19.....	194
7750 .....	273, 359	7798T1.....	201	7830M .....	196
7754-3 .....	203	7798T .....	201	7831A-12 .....	179
7755-1-0-4.....	203	7800MF.....	201	7831A-15 .....	179
7755-1-0-5.....	203	7802C .....	198	7831A-18 .....	179
7755-1-0-6 .....	203	7802P .....	198	7831A-20 .....	179
7756-2 .....	203	7802S-1.....	199	7832 .....	179
7761-1 .....	359	7802S-2.....	199	7833A-12 .....	179
7761-2 .....	359	7802S-3.....	199	7833A-15 .....	179
7761B-1.....	359	7802S-4.....	199	7833A-18 .....	179
7761B-2.....	359	7802S-5.....	199	7833A-20 .....	179
7761BC1 .....	359	7803B .....	200	7834 .....	179
7761BC2.....	359	7803C .....	199	7835 .....	205
7761BC3.....	359	7803S-1.....	199	7837-18 .....	197
7761C1 .....	359	7803S-2.....	199	7838 .....	204
7761C2.....	359	7803S-3.....	199	7839 .....	190
7761C3 .....	359	7803SAT-3 .....	218	7840 .....	225
7762-1 .....	363	7804-11.....	199	7843-1 .....	230
7762-2 .....	363	7804-13.....	199	7843A-1.....	227
7762-5 .....	358	7804-9.....	199	7844T3L20 .....	229
7762A-1.....	363	7805-11.....	200	7844T3L25.....	229
7762A-2 .....	363	7805-13.....	200	7844T3L30 .....	229
7762A-5 .....	358	7808L-1.....	204	7844T3L35.....	229
7762A4.....	356	7808L-2 .....	204	7844T3L40 .....	229
7762B-1.....	352	7808L-3 .....	204	7844T3L45 .....	229
7763-1 .....	353	7808M .....	204	7844T3L50 .....	229
7763-2 .....	353	7809MF.....	200	7844T3L55.....	229
7763 .....	353	7810-3 .....	203	7844T3L60.....	229
7764 .....	353	7810-4 .....	203	7844T5L20 .....	228
7765 .....	196	7810 .....	203	7844T5L25 .....	228
7766 .....	317	7811 .....	205	7844T5L30 .....	228
7768-1 .....	186	7812 .....	194	7844T5L35.....	228
7768 .....	186	7813-1 .....	202	7844T5L40.....	228
7771 .....	348	7813 .....	202	7844T5L45 .....	228
7771AS10.....	348	7814 .....	195	7844T5L50 .....	228
7771B .....	348	7814M .....	195	7844T5L55 .....	228
7771C .....	348	7815 .....	195	7844T5L60.....	228
7773 .....	202	7819 .....	196	7844T6L20.....	229
7774 .....	194	7820 .....	197	7844T6L25 .....	229
7776 .....	248	7821A .....	199	7844T6L30.....	229
7777 .....	248	7821B .....	199	7844T6L35 .....	229
7778-1 .....	248	7822 .....	197	7844T6L40.....	229
7778 .....	248	7823 .....	196	7844T6L45.....	229
7778K1 .....	248	7825 .....	197	7844T6L50.....	229
7778K .....	248	7826-1-7.....	196	7844T6L55 .....	229
7779MF-1.....	191	7828-1-10.....	194	7844T6L60.....	229
7779MF-2 .....	191	7828-1-13.....	194	7844T74L20 .....	228
7779MF-3 .....	191	7828-1-16.....	194	7844T74L25.....	228
7779MF-4.....	191	7828-1-19.....	194	7844T74L30 .....	228
7779MF-5CC.....	191	7828-10.....	194	7844T74L35.....	228
7781 .....	255, 290	7828-13 .....	194	7844T74L40 .....	228

7844T74L45 .....	228	9912-7 .....	295	CP304-2 .....	319
7844T74L50 .....	228	9912-8 .....	295	CP304-3.....	319
7844T74L55.....	228	9912-9 .....	295	CP304-4 .....	319
7844T74L60.....	228	9913-1 .....	295	CP304-5 .....	319
7857 .....	201	9913-2 .....	295	CP304-6 .....	319
7866-13.....	196	9913-3 .....	295	CP304-8 .....	319
7867-1 .....	177	9913-4 .....	295	CP304-9.....	319
7867-2 .....	177	9913-5 .....	295	CP304B-10.....	319
7867-3 .....	177	9913-6 .....	295	CP304B-12.....	319
7867-4 .....	177	CEP10 .....	355	CP304B-2 .....	319
7872-24.....	192	CEP20 .....	370	CP304B-3 .....	319
7874MF-22 .....	192	CEP30 .....	373	CP304B-4 .....	319
7874MF-25 .....	192	CEV980-3.....	304, 384	CP304B-5.....	319
7874MF-34 .....	192	CEV984.....	304, 384	CP304B-6.....	319
7874MF-40.....	192	CP1100.....	308	CP304B-8.....	319
7875 .....	191	CP1102.....	308	CP305 .....	318
7876-100 .....	191	CP1103.....	308	CP305L .....	318
7876-120.....	191	CP1104.....	310	CP305R.....	318
7876-160.....	191	CP1105.....	310	CP306 .....	325
7876-60.....	191	CP1106.....	310, 329	CP309-10-14 .....	320
7876-80.....	191	CP1107.....	310	CP309-12-16 .....	320
7878 .....	351	CP1109.....	308	CP309-14-16.....	320
7879 .....	195	CP16-1 .....	190	CP309-14-18.....	320
7881 .....	205	CP16 .....	190	CP309-8-12 .....	320
7882 .....	183	CP17-1 .....	278	CP310 .....	351, 369
7884 .....	368	CP17-2 .....	278	CP310D.....	351, 369
7885 .....	284	CP17-3 .....	278	CP310E.....	351, 369
7885A .....	284	CP17 .....	278	CP313-1.....	308, 310, 318
7886 .....	284	CP21-3 .....	328	CP313 .....	310, 318
7888 .....	285	CP21A-3.....	328	CP314-14.....	320
7895 .....	205	CP23-10.....	326	CP315 .....	319
7896-1 .....	335	CP23-4.....	326	CP315D .....	319
7896-2 .....	335	CP23-6.....	326	CP315G .....	319
7896-3 .....	335	CP23-8.....	326	CP316 .....	249
7897 .....	372	CP23A-8 .....	326	CP317 .....	318
7898 .....	371	CP291 .....	324	CP318 .....	320
7899 .....	371	CP300 .....	317	CP322 .....	320
7906 .....	195	CP301-10.....	323	CP324 .....	318
7920 .....	197	CP301-1.....	322	CP330-3-0.....	300, 375
7921 .....	202	CP301-2 .....	322	CP330-4-0.....	300, 375
7923 .....	202	CP301-3 .....	322	CP331-1.....	327
7945T .....	185	CP301-4.....	322	CP331 .....	327
7960T40.....	204	CP301-5.....	324	CP332 .....	178
8812-1 .....	294	CP301-6.....	322	CP333 .....	317
8812-2 .....	294	CP301-8.....	321	CP335 .....	327
8812-3 .....	294	CP301-9.....	322	CP335P.....	327
8812-4 .....	294	CP301 .....	322	CP337-1.....	350, 373
8812-5 .....	294	CP302-4 .....	174	CP337 .....	375
8814T1 .....	295	CP302-5 .....	174, 311	CP340 .....	325
8814T2.....	295	CP302-6 .....	174, 311	CP341 .....	325
8814T3.....	295	CP302-8 .....	174, 311	CP344A.....	249
8814T4.....	295	CP304-10.....	319	CP344AT.....	249
8814T5.....	295	CP304-12.....	319	CP344B.....	249, 369
8820 .....	294	CP304-14.....	319	CP344BT.....	249
9511007.....	76	CP304-15.....	319	CP344C.....	249
9622400.....	138	CP304-16.....	319	CP344CT.....	249

CP344D.....	249	CP391-4 .....	183	CP624-45 .....	371
CP344DT .....	249	CP391.183, 205, 208, 212, 217, 288, 367		CP624-55.....	371
CP344E .....	249	CP391E.....	183	CP624-65 .....	371
CP344ET .....	249	CP391M .....	183	CP624-75.....	371
CP345-1 .....	180	CP391V.....	183	CP624LF-75.....	371
CP345 .....	180	CP392-10R.....	175, 210	CP625 .....	350
CP348 .....	187, 330	CP392-14R.....	175	CP626 .....	350
CP350 .....	187, 330	CP392-1R.....	175	CP627 .....	350
CP351-1.....	189	CP392-2R .....	175	CP628 .....	316
CP351-2 .....	189	CP392-3R.....	175	CP630 .....	327
CP351-3.....	189	CP392-5R .....	175, 210	CP632 .....	328
CP351-5 .....	189	CP392-8R .....	175	CP635 .....	330
CP351-6 .....	189	CP392-9R .....	175, 210	CP637 .....	190, 333
CP351-7.....	189	CP392BI.....	175	CP640 .....	314
CP352 .....	188	CP392BS .....	175	CP801-10 .....	311
CP352-1.....	188	CP393-2.....	175	CP801-7.....	311
CP352-2 .....	188	CP393-3.....	175	CP802 .....	311
CP352-3.....	188	CP393-4.....	175	CP803 .....	327
CP352 .....	188	CP393 .....	175, 210, 229, 262, 275, 354	CP806 .....	311
CP353 .....	330	CP400-1.....	180	CP807 .....	311
CP354 .....	189	CP400-2.....	180	CP808-6.....	311
CP354A .....	189	CP400 .....	180	CP809 .....	322
CP355 .....	188	CP401 .....	179	CP810 .....	322
CP355A .....	188	CP406 .....	179	CP814-1.....	264
CP355C.....	188	CP407 .....	179	CP814-2 .....	59, 264
CP356 .....	332	CP409 .....	179	CP814-3 .....	59, 264
CP357-1.....	331	CP414 .....	179	CP818-10 .....	186
CP357-2 .....	331	CP415 .....	179	CP818-12.....	186
CP358 .....	187	CP420 .....	180	CP818-15.....	186
CP358A .....	187	CP501B .....	250	CP818-20.....	186
CP359 .....	189, 332	CP511 .....	350	CP818-8.....	186
CP360 .....	333	CP521 .....	249	CP819-12.....	326
CP362 .....	332	CP522 .....	250	CP819-15.....	326
CP363 .....	329	CP604-15.....	178	CP821 .....	292
CP364 .....	250	CP604 .....	178	CP821B.....	292
CP365 .....	332	CP604BR.....	175, 308	CP821C .....	292
CP367-1.....	330	CP604M .....	182	CP821D .....	292
CP367 .....	330	CP605-15.....	178	CP821E.....	292
CP369-1 .....	331	CP605 .....	178	CP822-10.....	186, 325
CP369-2.....	331	CP605BR .....	175	CP822-12 .....	186, 325
CP369-3.....	331	CP605M .....	182	CP822-14 .....	186, 325
CP37 .....	182	CP606-15.....	178	CP823-5.....	315
CP380-1 .....	329	CP606 .....	178	CP824-5.....	315
CP380-2 .....	329	CP606A .....	178	CP825 .....	313
CP380-3.....	329	CP609 .....	186, 328	CP826-1 .....	326
CP380-5 .....	329	CP611 .....	174	CP826 .....	326
CP380 .....	329	CP612 .....	331	CP827 .....	323
CP381 .....	363	CP613 .....	331	CP828 .....	323
CP390-1.....	183	CP614 .....	187, 330	CP829T.....	314
CP390-2 .....	183	CP615-1.....	188, 331	CP830 .....	314
CP390-3 .....	183	CP615-2 .....	331	CP845 .....	313
CP390-5 .....	183	CP615-3 .....	331	CP85AL .....	313
CP390-7.....	183	CP616-13.....	189, 333	CP85AR.....	313
CP390-8 .....	183	CP616-15.....	189, 333	CP85L .....	289
CP390L26.....	183	CP621 .....	357	CP85R .....	289
CP391-3 .....	183	CP622-4 .....	366	CP901 .....	320

CP902 .....	320	CP984 .....	369	MCEN134.....	347
CP903 .....	320	CP985 .....	312	MCEN135.....	347
CP904 .....	323	CP986 .....	316	MCEN136.....	347
CP905-1.....	323	CP988-15.....	181	MCEN136SC.....	37, 139, 167, 347
CP905 .....	323	CP988-18.....	181	MCEN138.....	344
CP907 .....	317	CP988-20.....	181	MCEN138S .....	346
CP908 .....	311	CP991L.....	312	MCEN139.....	344
CP914 .....	189	CP991R.....	312	MCEN139A .....	344
CP919-A.....	331	CP994 .....	314	MCEN140 .....	344
CP919 .....	331	CP996 .....	326	MCEN140A.....	344
CP921 .....	333	CP997 .....	329	MCEN141 .....	344
CP922 .....	334	CP998-1.....	321	MCEN141A.....	344
CP922A.....	190, 334	CP998 .....	321	MCEN142 .....	344
CP922B.....	334	M801 .....	180	MCEN143.....	344
CP928 .....	249	M809 .....	316	MCEN147.....	344
CP931-1.....	188	M815A .....	312	MCEN148 .....	344
CP931-3 .....	188	M815B .....	312	MCEN149W.....	344, 347
CP931-5 .....	188	M821A .....	336	MCEN150 .....	338
CP931 .....	188	M823A .....	336	MCEN151 .....	338
CP933-14 .....	178	M823B .....	336	MCEN152.....	338
CP933-16 .....	178	M823D.....	336	MCEN153.....	338
CP933-18 .....	178	M832 .....	180	MCEN154.....	338
CP934-1.....	180	M833 .....	180	MCEN155.....	338
CP934 .....	180	MCEN100-2-0.....	367	MCEN156 .....	338
CP936 .....	180	MCEN100-2-5 .....	367	MCEN157.....	338
CP938-1 .....	182	MCEN100-3-0.....	367	MCEN158.....	338
CP941 .....	316	MCEN100-3-5.....	367	MCEN160 .....	340
CP944 .....	312	MCEN101.....	367	MCEN161 .....	340
CP946 .....	312	MCEN102 .....	368	MCEN162 .....	340
CP947 .....	325	MCEN103 .....	270	MCEN163.....	340
CP949-45.....	371	MCEN10 .....	351	MCEN164 .....	340
CP949-55.....	371	MCEN103LDG.....	376	MCEN165.....	340
CP949-75.....	371	MCEN104.....	349	MCEN167.....	340
CP956 .....	324	MCEN105 .....	367	MCEN168 .....	340
CP957 .....	324	MCEN106.....	349	MCEN169 .....	340
CP958 .....	313	MCEN107 .....	349	MCEN170 .....	340
CP959 .....	313	MCEN109.....	349	MCEN171 .....	340
CP960 .....	313	MCEN110.....	343	MCEN183.....	374
CP961-1.....	335	MCEN111.....	343	MCEN18.....	362
CP961 .....	335	MCEN112 .....	343	MCEN184 .....	374
CP963-1.....	250	MCEN11 .....	368	MCEN186 .....	374
CP963-2.....	250	MCEN114 .....	343	MCEN187.....	374
CP973 .....	321	MCEN115-6 .....	343	MCEN189 .....	346
CP974 .....	321	MCEN115-8 .....	343	MCEN190 .....	346
CP975 .....	321	MCEN115-9 .....	343	MCEN191 .....	346
CP975A.....	321	MCEN115-9 .....	343	MCEN192 .....	346
CP976 .....	321	MCEN116 .....	343	MCEN193.....	346
CP978 .....	322	MCEN117 .....	343	MCEN19 .....	362
CP980-35.....	336	MCEN118 .....	343	MCEN194 .....	346
CP980-40.....	336	MCEN120 .....	343	MCEN195 .....	346
CP980-45.....	336	MCEN12.....	353	MCEN211 .....	346, 364
CP980-50.....	336	MCEN127.....	350	MCEN211S.....	346, 364
CP980-55.....	336	MCEN128.....	367	MCEN212 .....	346, 364
CP981 .....	336	MCEN130 .....	347	MCEN212S.....	346, 364
CP982 .....	179	MCEN131 .....	347	MCEN213.....	346, 364
CP984-1.....	369	MCEN133.....	347	MCEN21.....	354

MCEN213S .....	346, 364	MCEN37-2-5 .....	375	MCEN67-1 .....	360
MCEN214 .....	344	MCEN37-3-0 .....	375	MCEN67-2 .....	360
MCEN215 .....	344	MCEN37-3-5 .....	375	MCEN67 .....	360
MCEN216L .....	344	MCEN371D35 .....	375	MCEN68 .....	361
MCEN216R .....	344	MCEN371D4 .....	375	MCEN68ADG .....	349
MCEN217L .....	344	MCEN37D4 .....	375	MCEN68BDG .....	349
MCEN217R .....	344	MCEN38 .....	357	MCEN68CDG .....	349
MCEN217S .....	344	MCEN39 .....	374	MCEN713 .....	369
MCEN217U .....	344	MCEN39L .....	383	MCEN720 .....	341, 369
MCEN218 .....	346	MCEN41-1 .....	332, 370	MCEN721 .....	341, 369
MCEN21R .....	354	MCEN41D3 .....	370	MCEN723 .....	369
MCEN23-2-5 .....	375	MCEN41J .....	370	MCEN728DG .....	349
MCEN23-3-0 .....	375	MCEN42-1 .....	333, 370	MCEN730 .....	367
MCEN2 .....	372	MCEN42 .....	333, 370	MCEN73 .....	360
MCEN25-4-0 .....	383	MCEN42J1 .....	370	MCEN74 .....	360
MCEN27-1 .....	352	MCEN42J .....	370	MCEN75 .....	360
MCEN27-2 .....	341, 352	MCEN43 .....	362	MCEN75 .....	362, 370
MCEN27-3 .....	352	MCEN4 .....	362	MCEN7600 .....	341
MCEN27 .....	352	MCEN44 .....	366	MCEN760 .....	341
MCEN27R .....	352	MCEN49 .....	362	MCEN761 .....	341
MCEN28-1 .....	363	MCEN4DG .....	358	MCEN762 .....	341
MCEN28 .....	363	MCEN50 .....	255	MCEN763 .....	341
MCEN29 .....	362	MCEN53 .....	353	MCEN76 .....	360
MCEN320 .....	342	MCEN5 .....	362	MCEN764 .....	341
MCEN328S .....	342	MCEN54 .....	354	MCEN765 .....	341
MCEN328U .....	342, 363	MCEN54G .....	354	MCEN766 .....	341
MCEN329 .....	342	MCEN54H .....	352	MCEN767 .....	341
MCEN330 .....	342	MCEN54I .....	354	MCEN768 .....	341
MCEN33 .....	355	MCEN54K .....	354	MCEN769 .....	341
MCEN3 .....	362	MCEN54P .....	354	MCEN77-3-0 .....	376
MCEN34 .....	355	MCEN55 .....	351	MCEN77-3-5 .....	376
MCEN344S .....	342	MCEN56-1 .....	358	MCEN770B25 .....	376
MCEN344U .....	342	MCEN56 .....	358	MCEN770B30 .....	376
MCEN344V .....	342	MCEN58 .....	373	MCEN770J30 .....	373
MCEN345 .....	342	MCEN5B .....	362	MCEN770J40 .....	373
MCEN346 .....	342	MCEN5DG .....	358	MCEN78J30 .....	374
MCEN347 .....	342	MCEN61 .....	355	MCEN78J40 .....	374
MCEN348 .....	342	MCEN62A1 .....	357	MCEN79J25 .....	374
MCEN349 .....	342	MCEN62A2 .....	357	MCEN79J30 .....	374
MCEN350 .....	342	MCEN62A3 .....	357	MCEN79J40 .....	374
MCEN350H .....	356	MCEN62B1 .....	357	MCEN80 .....	383
MCEN350V .....	356	MCEN62B2 .....	357	MCEN81-C .....	377
MCEN351 .....	342	MCEN62B3 .....	357	MCEN81-S .....	380
MCEN35 .....	361	MCEN62T1 .....	357	MCEN81-W .....	381
MCEN35JH .....	356	MCEN62T2 .....	357	MCEN81O1 .....	378
MCEN35JV .....	356	MCEN62T3 .....	357	MCEN81O2 .....	379
MCEN360H .....	356	MCEN640 .....	354, 365	MCEN81O .....	378
MCEN360V .....	357	MCEN641 .....	365	MCEN82-C .....	377
MCEN36 .....	361	MCEN641K .....	365	MCEN82-S .....	381
MCEN364 .....	342	MCEN643 .....	365	MCEN82-W .....	382
MCEN365 .....	342	MCEN64 .....	365	MCEN82O .....	379
MCEN36JH .....	356	MCEN643K .....	365	MCEN82O5 .....	379
MCEN37-1-20 .....	375	MCEN644 .....	365	MCEN82O6 .....	379
MCEN37-1-25 .....	375	MCEN64K .....	365	MCEN83-C .....	377
MCEN37-1-30 .....	375	MCEN65 .....	360	MCEN83-S .....	380
MCEN37-2-0 .....	375	MCEN66 .....	360	MCEN83-W .....	381

MCEN83O .....	378	MCL-S38.....	220	MCL206A1 .....	238
MCEN83OL .....	378	MCL-S39.....	220	MCL206A2 .....	238
MCEN84S.....	383	MCL-S41.....	220	MCL206A3.....	238
MCEN87-S.....	380	MCL-S4.....	215, 219	MCL206A4.....	238
MCEN87C.....	377	MCL-S42 .....	221	MCL206A5.....	238
MCEN87O3 .....	379	MCL-S43.....	221	MCL206C.....	238
MCEN87O4 .....	379	MCL-S5.....	219	MCL206K.....	238
MCEN87W .....	382	MCL-S6 .....	221	MCL206P .....	238
MCEN88A .....	382	MCL-S7.....	215, 219	MCL210 .....	212
MCEN88P.....	382	MCL-S8.....	219	MCL219-1 .....	212
MCEN88SC .....	382	MCL-S9 .....	219	MCL219 .....	212
MCEN90 .....	358	MCL100.....	240	MCL241-1 .....	212
MCEN91 .....	358	MCL100T15.....	240	MCL241.....	212
MCEN91B .....	358	MCL100T20.....	240	MCL25 .....	227
MCEN92.....	363	MCL101.....	239	MCL290.....	212, 213
MCEN93.....	363	MCL10 .....	216	MCL291 .....	213
MCEN94.....	355	MCL102 .....	239	MCL291AD .....	213
MCEN95.....	355	MCL103 .....	241	MCL291AG .....	213
MCEN96oH .....	357	MCL110.....	231	MCL291FD.....	213
MCEN96.....	356	MCL111.....	231	MCL291FG.....	213
MCEN96J.....	357	MCL112 .....	231	MCL29 .....	216
MCEN97 .....	356	MCL11 .....	239	MCL294.....	212
MCEN98.....	361	MCL112F.....	231	MCL295 .....	212
MCEN99.....	361	MCL112H .....	210, 226, 231	MCL30.....	216
MCL-S0 .....	215, 219	MCL120 .....	222	MCL31 .....	216
MCL-S10.....	219	MCL121.....	222	MCL320.....	226
MCL-S11.....	219	MCL122.....	222	MCL320F.....	226
MCL-S1 .....	215, 219	MCL12 .....	228	MCL330.....	226
MCL-S12 .....	219	MCL123.....	222	MCL330F.....	226
MCL-S13 .....	219	MCL124.....	222	MCL33 .....	228
MCL-S14 .....	219	MCL124FL.....	223	MCL340.....	230
MCL-S15 .....	219	MCL124FR .....	223	MCL34 .....	229
MCL-S16 .....	215, 219	MCL124ST .....	223	MCL35 .....	218, 223
MCL-S17-1 .....	219	MCL125.....	222	MCL359 .....	290
MCL-S17 .....	219	MCL125FL.....	223	MCL37 .....	234
MCL-S18 .....	219	MCL125FR .....	223	MCL37C.....	234
MCL-S19.....	215, 219	MCL125ST .....	223	MCL37CF.....	234
MCL-S20 .....	221	MCL13 .....	228	MCL37D.....	234
MCL-S21.....	220	MCL14 .....	228	MCL37DF.....	234
MCL-S21R.....	214	MCL15 .....	216	MCL37G.....	235
MCL-S2.....	219	MCL16 .....	216	MCL38N .....	235
MCL-S22.....	220	MCL170.....	237, 381	MCL42 .....	234
MCL-S22R .....	214	MCL171 .....	381	MCL4 .....	233
MCL-S23.....	220	MCL17 .....	216	MCL46 .....	234
MCL-S24.....	220	MCL174.....	237, 380	MCL46A .....	234
MCL-S25.....	215, 221	MCL18 .....	216	MCL47 .....	234
MCL-S26 .....	221	MCL190 .....	217	MCL48 .....	239
MCL-S27.....	220	MCL191.....	217	MCL49.....	225
MCL-S30 .....	220	MCL19 .....	216	MCL49F.....	225
MCL-S31 .....	220	MCL197.....	237, 378	MCL51 .....	236
MCL-S3.....	219	MCL19BIS.....	216	MCL52 .....	236
MCL-S32.....	220	MCL1BIS .....	233	MCL5 .....	233
MCL-S33.....	220	MCL200.....	198	MCL53 .....	236
MCL-S34.....	220	MCL201.....	198	MCL54 .....	236
MCL-S35.....	220	MCL205.....	212	MCL55-1 .....	217
MCL-S36.....	140, 221	MCL206 .....	238	MCL55-2 .....	217



MCL55-3.....	217	MCL925L30 .....	240	MCLS44.....	224
MCL55 .....	216	MCL925L35 .....	226, 240	MCLS45.....	224
MCL55B.....	217	MCL925L45.....	240	MCLS46.....	224
MCL55R.....	232	MCL93-2 .....	217	MCLS47.....	224
MCL55T.....	232	MCL930L25 .....	240	MCLS48.....	224
MCL55T4.....	232	MCL930L30 .....	240	MCLS49.....	224
MCL55T5.....	232	MCL930L35.....	226, 240	MCLS50.....	224
MCL55T6 .....	232	MCL930L45 .....	240	MCLS51 .....	224
MCL55U .....	232	MCL930L55 .....	240	MCLS52 .....	224
MCL56BL.....	217, 227	MCL93 .....	217	MCLS53 .....	224
MCL56BR .....	217, 227	MCL935L25.....	241	MCLS54.....	224
MCL56PL.....	227	MCL935L30.....	241	MCLS55.....	224
MCL56PR .....	227	MCL935L35.....	226, 241	MCLS56.....	224
MCL57 .....	216	MCL935L45.....	241	MCLS57.....	224
MCL58 .....	216	MCL935L55.....	241	MCLS58.....	224
MCL59 .....	217	MCL940L25 .....	241	MCLS59.....	224
MCL62 .....	240	MCL940L30.....	241	MCLS60 .....	224
MCL63 .....	236	MCL940L35 .....	226, 241	MCLS61 .....	224
MCL63F.....	236	MCL940L45.....	241	MCLS62.....	224
MCL65A.....	235	MCL940L55.....	241	MCLS62SC .....	224
MCL65AF.....	235	MCL94 .....	217	MCLS63.....	224
MCL65AS .....	235	MCL94G .....	242	MCLS64.....	224
MCL67 .....	216	MCL94IG .....	243	MCLS65.....	224
MCL68 .....	216	MCL94IP .....	243	MCLS66.....	224
MCL69.....	216	MCL94IPR .....	243	MCLT00.....	209
MCL700 .....	218	MCL98.....	242	MCLT10 .....	209
MCL710 .....	218	MCLB1 .....	216	MCLT11 .....	209
MCL7 .....	230	MCLB2SC .....	215	MCLT12R .....	210
MCL75 .....	380	MCLB30.....	214	MCLT20.....	209
MCL76 .....	218, 223	MCLB31 .....	214	MCLT21.....	209
MCL77 .....	218	MCLB94.....	214	MCLT21R .....	210
MCL78 .....	218	MCLP00 .....	208	MCLT30.....	209
MCL79 .....	218	MCLP10.....	208	MCLT40.....	209
MCL81BL .....	217, 227	MCLP20.....	208	MCLT40R .....	210
MCL81BR.....	217, 227	MCLP25.....	208	MCLT50.....	209
MCL81PL.....	227	MCLP30.....	208	MCLT50R.....	210
MCL81PR.....	227	MCLP40 .....	208	MCLW10.....	239, 344
MCL82 .....	217	MCLP50.....	208	MCLW11.....	239, 344
MCL828 .....	230	MCLP60 .....	208	MCM10-0-5 .....	192
MCL828C .....	230	MCLP70.....	208	MCM10-1-0.....	192
MCL83-1 .....	235	MCLP80 .....	210	MCM12R.....	185
MCL83 .....	235	MCLS120-1.....	223	MCM13-1 .....	242
MCL84 .....	235	MCLS120-2 .....	223	MCM13 .....	242
MCL88-1.....	225	MCLS120-3 .....	223	MCM1R.....	184
MCL88-2 .....	225	MCLS121-1.....	223	MCM25-3 .....	192
MCL88 .....	225	MCLS121-2 .....	223	MCM4BISR.....	314
MCL89-1.....	235	MCLS121-3 .....	223	MCM4R .....	314
MCL89-2 .....	235	MCLS122-1 .....	223	MCM6BIS.....	315
MCL89 .....	235	MCLS122-2.....	223	MCM7BISR.....	239, 334
MCL92-1.....	233	MCLS122-3.....	223	MCM7R .....	334
MCL920L25 .....	240	MCLS123-1 .....	223	MCM970 .....	332
MCL920L30 .....	240	MCLS123-2.....	223	MCM973D3.....	315
MCL920L35 .....	226, 240	MCLS1233.....	223	MCM973D5.....	315
MCL920L45 .....	240	MCLS18R.....	214	MCO10 .....	255
MCL920L55 .....	240	MCLS37 .....	221	MCO10B .....	284
MCL925L25.....	240	MCLS40 .....	219	MCO10M.....	283



MCO1oMO .....	283	MCO221.....	288	MCO319.....	293
MCO12B .....	285	MCO221A .....	288	MCO320.....	267
MCO12C .....	285	MCO221MO .....	288	MCO321.....	267
MCO12D .....	253	MCO222 .....	272	MCO322 .....	267
MCO12E.....	286	MCO22 .....	273	MCO32 .....	255
MCO12H.....	285	MCO224-2-0 .....	268	MCO33oMO.....	304
MCO12J.....	285	MCO224A-2-0.....	268	MCO333.....	269
MCO12R .....	285	MCO224G .....	269	MCO337DL.....	268
MCO1 .....	300	MCO226 .....	279	MCO337DR.....	268
MCO13A.....	255	MCO2 .....	265	MCO340.....	278
MCO13B.....	273	MCO226A.....	279	MCO341.....	278
MCO13C .....	253	MCO226B.....	279	MCO342 .....	287
MCO13D .....	273	MCO226C .....	279	MCO34 .....	286
MCO13E.....	273	MCO23 .....	274	MCO343 .....	287
MCO14A .....	271	MCO233 .....	372	MCO351.....	262, 290
MCO16.....	267	MCO237.....	372	MCO352-20 .....	296
MCO17 .....	274	MCO23A .....	274	MCO352-25.....	296
MCO18A .....	274	MCO23B .....	274	MCO352-30 .....	296
MCO1B.....	300	MCO240.....	267	MCO35 .....	276
MCO201-2-5.....	299	MCO24 .....	274	MCO352E2o.....	299
MCO201-3-0.....	299	MCO250.....	264	MCO352E25 .....	299
MCO204B .....	280	MCO251.....	265	MCO352N2o.....	299
MCO204C .....	282	MCO25 .....	274	MCO353D1o.....	296
MCO205.....	255	MCO255 .....	265	MCO354 .....	301
MCO205A .....	278	MCO25H.....	273	MCO357A .....	290
MCO205B.....	278	MCO26 .....	275	MCO358 .....	290
MCO205C .....	278	MCO270 .....	260	MCO36 .....	276
MCO205D .....	278	MCO271.....	260	MCO366F1o.....	296
MCO207-1-5 .....	266	MCO272 .....	260	MCO366F12 .....	296
MCO207-2-0 .....	266	MCO27 .....	253, 255	MCO366F15 .....	296
MCO209.....	272	MCO29-1.....	287	MCO366F2o.....	296
MCO210 .....	268	MCO29o.....	275	MCO367F1o.....	296
MCO21.....	255	MCO291.....	262, 275	MCO367F12.....	296
MCO213-4 .....	253, 305	MCO29 .....	287	MCO367F15.....	296
MCO213-6 .....	305	MCO301.....	284	MCO367F2o.....	296
MCO214-13-10 .....	276	MCO302.....	279	MCO368F2o.....	296
MCO214-13-2o.....	276	MCO303 .....	279	MCO368F25.....	296
MCO214-13-4o .....	276	MCO304.....	279	MCO37-1.....	263, 271
MCO214-13-6o .....	276	MCO305.....	271	MCO37.....	263, 271
MCO214-13-8o .....	276	MCO306-2o.....	298	MCO37D.....	269
MCO215.....	286	MCO309.....	276	MCO37G.....	269
MCO216-3-5 .....	286	MCO31o.....	293	MCO38 .....	263
MCO218-4.....	287	MCO311-1-0 .....	299	MCO3Po5.....	298
MCO218-6.....	287	MCO311-1-2.....	299	MCO3Po7.....	298
MCO218-8.....	287	MCO311-1-5.....	299	MCO3P1o.....	298
MCO2184.....	287	MCO311-1-8.....	299	MCO3P12.....	298
MCO219B .....	274	MCO311-2-0.....	299	MCO3P15.....	298
MCO219C.....	274	MCO311-2-5.....	299	MCO3P18.....	298
MCO21A .....	275	MCO311-3-0.....	299	MCO3P2o.....	298
MCO21B .....	275	MCO311-3-5.....	299	MCO3P24 .....	298
MCO21C .....	275	MCO311-4-0.....	299	MCO3T-o-5.....	298
MCO21D.....	275	MCO312 .....	280	MCO3T-o-7 .....	298
MCO21F.....	275	MCO31 .....	288	MCO3T-1-0 .....	298
MCO21G.....	275	MCO313 .....	255	MCO3T-1-2.....	298
MCO21H.....	255, 275	MCO317 .....	280	MCO4 .....	255, 293
MCO21I.....	275	MCO318 .....	293	MCO4A.....	253, 255, 293

MCO4B.....	293	MCO770-3-0.....	297	MCO841.....	277
MCO4C.....	293	MCO770-3-5.....	297	MCO844.....	286
MCO4D.....	293	MCO770-4-0.....	297	MCO862.....	302
MCO4E.....	293	MCO770L15.....	300	MCO865-1.....	302
MCO4F.....	293	MCO770L20.....	300	MCO866.....	302
MCO5.....	281	MCO770L25.....	300	MCO890-1-04.....	300
MCO551.....	303	MCO770L30.....	300	MCO890-1-08.....	300
MCO551A.....	303	MCO770L35.....	300	MCO890-1-10.....	300
MCO551B.....	303	MCO770L40.....	300	MCO890-1-12.....	300
MCO571.....	305	MCO771-2-5.....	297	MCO890-1-15.....	300
MCO5A-1-0.....	281	MCO771-3-0.....	297	MCO890-1-20.....	300
MCO5A-1-5.....	281	MCO771-4-0.....	297	MCO890.....	300
MCO5A-2-0.....	281	MCO772.....	301	MCO8BM.....	267
MCO5A-2-5.....	281	MCO773.....	297	MCO9-1.....	271
MCO5B.....	281	MCO774-0-4.....	298	MCO901.....	288
MCO5C.....	281	MCO774-0-5.....	298	MCO904.....	270
MCO5D.....	282	MCO774-0-6.....	298	MCO905.....	270
MCO5E.....	282	MCO774D8.....	298	MCO906.....	270
MCO6.....	255, 283	MCO775-1.....	301	MCO910M.....	265
MCO649.....	253	MCO776.....	297	MCO915.....	279
MCO649SC.....	253	MCO781.....	276	MCO916.....	279
MCO650.....	280	MCO782L.....	272	MCO917.....	289
MCO651.....	253, 280	MCO782R.....	272	MCO918.....	289
MCO651F.....	281	MCO7A-1.....	255, 266	MCO920.....	279
MCO652.....	253, 280	MCO7A-3.....	255, 266	MCO924.....	289
MCO653.....	280	MCO7A-5.....	266	MCO925.....	270
MCO654-1.....	277	MCO7A6.....	266	MCO926.....	270
MCO654-2.....	277	MCO7AMO.....	266	MCO9.....	272
MCO655.....	253	MCO800.....	287	MCO928.....	270
MCO656.....	253	MCO801.....	287	MCO929.....	270
MCO657.....	253	MCO802.....	289	MCO932.....	282
MCO658.....	253	MCO803.....	268	MCO950.....	279
MCO660-10.....	253, 254	MCO804.....	280	MCO951.....	270
MCO660-12.....	254	MCO805.....	277	MCO960.....	274
MCO660-2.....	254	MCO805A.....	255, 277	MCO961.....	274
MCO660-8.....	254	MCO806.....	277	MCO970.....	288
MCO661-10.....	296	MCO806A.....	277	MCO971T.....	279
MCO661-7.....	296	MCO806B.....	277	MCO972.....	279
MCO662-1.....	277	MCO807.....	255, 278	MCO973T.....	279
MCO662-2.....	277	MCO812.....	279	MCO974.....	279
MCO663-1.....	277	MCO813.....	289	MCO978.....	304
MCO663-2.....	277	MCO817.....	271	MCO978S.....	294
MCO664.....	253	MCO818.....	267	MCO979.....	268
MCO665.....	253	MCO819.....	303	MCO980.....	304, 384
MCO666.....	253	MCO820.....	253	MCO981.....	304, 384
MCO667.....	253	MCO821-1.....	302	MCO981D.....	294, 304, 384
MCO670-1.....	254	MCO823.....	305	MCO982.....	304, 384
MCO6A.....	288	MCO824-1.....	302	MCO983-4.....	304, 384
MCO6B.....	255, 288	MCO8.....	269	MCO983.....	304, 384
MCO6C.....	283	MCO830.....	285	MCO985.....	305
MCO6M.....	283	MCO832A.....	277	MCO988.....	271
MCO7-1.....	266	MCO832B.....	277	MCO989.....	288
MCO7-3.....	266	MCO832C.....	277	MCO995.....	317
MCO770-1-5.....	297	MCO832D.....	277	MCO997.....	305
MCO770-2-0.....	297	MCO833C.....	277	MCOHo.....	255
MCO770-2-5.....	297	MCO833D.....	277	MCOHoSC.....	61, 118, 168, 346

MCOP23A.....	274	MCSKoSC.....	167, 232, 339
MCOP23B.....	274	MCSK1.....	339
MCOP25.....	275	MCSK2.....	339
MCOP337A.....	268	MCSK3.....	339
MCOP347A.....	282	MCSK4.....	339
MCOP347B.....	282	MCSK5.....	339
MCOP348A.....	282	MCSK6.....	339
MCOP348B.....	282	N480G.....	334
MCOP348C.....	282	P761-2.....	176
MCOP348D.....	282	P761-5.....	176
MCOP366A.....	297	P761-6.....	176
MCOP366B.....	297	P761-7.....	176
MCOP651.....	282	P761-8.....	176
MCOP7A3.....	265	P761T6.....	176
MCOP820.....	303	P762-2.....	176
MCOR15.....	252	P762-4.....	176
MCOR20.....	252	P763.....	182
MCOR25.....	252	P764-11.....	177
MCOR30.....	252	P764-1.....	177
MCOR35.....	252	P764-3.....	177
MCOR40.....	252	P764-5.....	177
MCOR45.....	252	P764-7.....	177
MCOR50.....	252	P765-14.....	177
MCOR55.....	252	P765-16.....	177
MCOR60.....	252	P766-12.....	181
MCOR65.....	252	P768-14.....	181
MCOR70.....	252	P769.....	177
MCOR75.....	252	P770.....	182
MCOR80.....	252	P771.....	181
MCOS10.....	261		
MCOS10SC.....	61, 168, 262, 342		
MCOS14.....	261		
MCOS15.....	261		
MCOS16.....	261		
MCOS17.....	261		
MCOS18.....	261		
MCOS19.....	261		
MCOS20.....	261		
MCOS21.....	261		
MCOS22.....	261		
MCOS23.....	261		
MCOS25.....	261		
MCOS26.....	261		
MCOS27.....	261		
MCOS29.....	261		
MCOS30.....	261		
MCOS31.....	261		
MCOS32.....	261		
MCOS33.....	262		
MCOS34.....	262		
MCOS35.....	262		
MCOS36.....	262		
MCP5R-5.....	315		
MCR2A.....	198		
MCR3A.....	198		
MCSKo.....	339		

**A**

**ABITBOL**

Accessories.....212  
 Fiberoptic Light Source.....213  
 Laryngoscope.....212  
 Laser Microlaryngeal Instruments.....212  
     Monopolar Alligator Forceps .....212  
     Monopolar Cable.....212  
     Monopolar Grasping Forceps.....212  
     Monopolar Heart-Shape Grasping Forceps.....212  
     Suction Tube Insulated .....212

**ACCESSORIES**

Abitbol Accessories .....212  
 Parsons Accessories .....341  
 Silicone Mat.....192  
 Stainless Steel Cups .....191  
 Stainless Steel Plate.....192  
 Stainless Steel Trays .....192

**ADAPTERS**

Cleaning Adapter .....383  
 Darrouzet Suction Irrigation Adapter .....303  
 House Suction Adapter .....34, 297  
 Luer-Lock Adapter.....232, 301

**ADENOID CURETTES**

Adenoid Curettes (Disposable) .....120  
 Barnhill Adenoid Curettes.....120  
 Lermoyer Adenoid Curette .....196  
 Middleton Adenoid Curette.....120  
 Moure Adenoid Curette .....194  
 Reverse Adenoid Curettes.....121  
 Stubbs Adenoid Curettes .....121

**ADENOID DEPRESSORS**

Wieder Tongue Depressor .....127

**ADENOID FORCEPS**

Allis-Coakley Tonsil Forceps .....121  
 Chatelier Adenoid Forceps .....198  
 Ferris-Smith Sponge/Fragment Forceps .....121  
 Schnidt-Boettcher Tonsil Forceps.....122  
 Schnidt Tonsil Forceps .....122  
 St. Claire Thompson Adenoid Forceps .....122  
 White Tonsil Forceps .....122

**ADENOID PUNCHES**

King Adenoid Punch .....126  
 Meltzer Adenoid Punch .....126  
 Ronis Adenoid Punch .....126

**ADENOID RETRACTORS**

Hurd Dissector/Pillar Retractor.....123  
 Love Uvula Retractor .....127  
 Morrison-Hurd Dissector and Pillar Retractor .....123  
 News Tracheal Retractor.....127

**ADENOID SCISSORS**

Dean Tonsil Scissors .....128  
 Metzenbaum Scissors .....128

**ADENOID SNARES/WIRE**

Bruenings Tonsil Snare.....202  
 Eve Tonsil Snare .....128  
 Sage Tonsil Snare .....128  
 Snare Wire, Pre-Cut .....129  
 Tyding Tonsil Snare.....129  
 Vacher Tonsil Snare .....203

**ADENOID SUCTION TUBES**

Andrews-Pynchon Suction Tube .....129  
 Andrews Suction Tube .....129  
 Yankauer Suction Tube.....129

**ADENOTOMES**

Laforce Adenotomes .....20

**ADSON**

Bipolar Forceps.....175  
 Dressing Forceps.....146  
 Dressing/Tissue Forceps .....178  
 Hemostatic Forceps.....164  
 Monopolar Forceps.....182  
 Tissue Forceps.....147, 178  
 Tissue Forceps Delicate.....147  
 Tissue Forceps w/Tungsten-Carbide Jaws .....145

**ADSON-TUBIANA**

Forceps, Delicate.....180

**AGRIS-DINGMANN**

Elevator/Dissector.....312

**AIACH**

Osteotome.....318

**ALBERTINI**

Catheter Guide.....348  
 Drain Tube.....348  
 Trocar and Cannula.....348

**ALLIGATOR**

Bellucci Alligator Forceps, Delicate .....9  
 House Alligator Crimping Forceps.....12  
 Jackson Alligator Grasping Forceps .....140  
 Kleinsasser Microlaryngeal Alligator Forceps .....136  
 Laryngeal Alligator Forceps W/Cleaning Port .....227  
 Monopolar Alligator Forceps.....212  
 Micro Alligator Forceps.....274  
 Micro Alligator Forceps, W/Tube Shaft .....274  
 Microlaryngeal Alligator Forceps.....136  
 Miniature Alligator Ear Forceps.....9  
 Panther Alligator Forceps .....9  
 Prades Alligator Forceps .....362  
 Rouvier Alligator Forceps.....362  
 Thomassin Alligator Forceps .....276  
 Very Fine Alligator Ear Forceps.....9

**ALLIS**

Tissue Forceps.....164  
 Haemostatic Forceps, Delicate .....181

**ALLIS-COAKLEY**

Tonsil Forceps.....121



<b>ALLPORT</b>	
Incus Hook.....	17
<b>ANDERSON-NEIVERT</b>	
Osteotome.....	90
<b>ANDREWS</b>	
Suction Tube .....	129
<b>ANDREWS-PYNCHON</b>	
Suction Tube .....	129
<b>ANGOT-VANECLOO</b>	
Retractor .....	290
<b>ANTRUM</b>	
Antrum Punch, Sidebiting .....	97
Lichtwicz Antrum Trocar Needle .....	117
Ostrum Antrum Backbiter Punch .....	97
Wiener Antrum Rasp .....	99
<b>APFELBAUM</b>	
Monopolar Suction Tube .....	367
<b>APRIL</b>	
Oral Stabilizer.....	198
<b>APPLICATORS</b>	
Cotton Applicator .....	242
Farrell Applicator .....	64
Lathbury Applicator .....	64
<b>APPROXIMATOR</b>	
Gilbert-O'Brien Approximator .....	242
<b>ARCUS-MARGINALIS</b>	
Dissector.....	154
<b>AREOLA</b>	
Areola Breast Marker .....	335
<b>ARMY-NAVY</b>	
Retractor .....	100
<b>ARTICULATING</b>	
Articulating Frontal Sinus Punch .....	95
<b>ASCH</b>	
Septum Straightening Forceps.....	71
<b>ASTON-DANIEL</b>	
Endoscopic Cannula.....	140
<b>AUFRICHT</b>	
Nasal Retractor .....	100, 325
Rasps .....	321
<b>AUSTIN</b>	
Attic Dissector.....	38
Chisel.....	39
Duckbill Knife Elevator.....	38
Excavator .....	38
Footplate Elevator .....	39
Footplate Hook .....	39
Knife Elevator.....	38
Needle Pick.....	38
Pick .....	39
Sickle Knife.....	39
Strut Caliper .....	39
<b>AWL</b>	
Bone Awl .....	336
<b>B</b>	
<b>BABCOCK</b>	
Tissue Forceps.....	164
<b>BACKBITER</b>	
Backbiting Forceps, Rotatable .....	95, 352
Backbiting Forceps .....	352
Micro Backbiting Forceps .....	96
Ostrum Antrum Backbiter Punch .....	97
<b>BACKHAUS</b>	
Towel Forceps.....	166, 181
<b>BALL</b>	
Ball Elevator.....	68
Ball Tip Coagulator .....	183
<b>BALLENGER</b>	
Swivel Knife .....	86, 366
V-Shaped Chisel.....	65
<b>BARBARA</b>	
House Barbara Pick.....	43
<b>BARNES</b>	
Suction Tube .....	32
<b>BARNHILL</b>	
Adenoid Curettes .....	120
<b>BARON</b>	
Suction Tube .....	32
<b>BARRAQUER</b>	
Needle Holder .....	184
<b>BARRAYA</b>	
Dissecting Forceps.....	178
<b>BAYONET</b>	
Elevator .....	267
<b>BEAVER</b>	
Knife Handle .....	292
<b>BECKER</b>	
Converse Scissors .....	329
Osteotome.....	318
Rhinoplasty Instruments .....	310
Osteotome, Guarded .....	310
Rasp, Double-Ended .....	310
Becker Converse Scissors .....	310
Needle Holder w/Tungsten-Carbide Blades .....	310
Septum Scissors.....	106
Wire Scissors w/Tungsten Carbide Blades ..	162, 187, 329
<b>BECKMAN</b>	
Nasal Specula .....	112
Speculum .....	371
<b>BECKMAN-WEITLANER</b>	
Retractor .....	290
<b>BELLOC</b>	
Rasps .....	321

**BELLUCCI**

Alligator Forceps Delicate..... 9  
 Scissors Micro Black Finish.....25  
 Scissors Miniature Fine .....25  
 Scissors Very Fine .....25  
 Suction Tube .....33

**BELLUCCI-WULLSTEIN**

Retractor .....21

**BENNINGER**

MicroLaryngeal Instrument Set.....214  
 Micro Scissors.....214  
 Suture Knot Pusher .....214  
 Needle Driver .....214  
 Cup Forceps.....214  
 Heart Shape Grasper .....214  
 Alligator Forceps.....214

**BEYER**

Beyer Bone Rongeur, Double-Action ..... 329  
 Beyer Bone Rongeur, Single-Action .....23, 103

**BIGOT**

Rasps .....321

**BILLEAU**

Ear Loop .....20, 284  
 House-Billeau Ear Loop ..... 20

**BIOPSY/GRASPING**

Biopsy and Grasping Forceps ..... 71  
 Biopsy and Grasping Forceps, Long.....71  
 Hilyard Post-Nasal Biopsy Forceps .....75

**BIPOLAR**

Adson Bipolar Forceps..... 175  
 Bipolar Cables ..... 175  
 Bipolar Electrode ..... 352  
 Coagulating Forceps, Insulated ..... 175, 210  
 Dessi Bipolar Forceps .....354  
 Dessi Bipolar Forceps, Detach .....354  
 Jewelers Forceps ..... 315  
 Magnan Bipolar Forceps ..... 175

**BIRKET**

Tonsil Seizing Forceps .....196

**BISHOP-HARMON**

Dressing Forceps..... 147  
 Tissue Forceps..... 147

**BIZEAU**

Retractor .....290

**BLADES**

Davis Ring Blades..... 125  
 Ear Knife Blade (Disposable)..... 18  
 Myringotomy Knife Blade (Disposable) .....19  
 Politzer Lancet Knife Blade .....283

**BLAIR**

Retractor ..... 100

**BLAKESLEY**

Forceps..... 352  
 Forceps-Fenestrated.....353

Forceps Thru-Cut..... 72  
 Nasal Suction Forceps, Thru-Cut.....81  
 Septum Forceps ..... 71

**BLITZER**

Laryngeal Knife Handle..... 138  
 Laryngeal Knives (Disposable) ..... 138

**BLONDIAU**

Bone Curette.....194

**BLUNT**

Ear Loop ..... 284  
 Hook.....277  
 Pick .....287

**BOETTCHER**

Tonsil Scissors..... 329

**BOISE**

Nasal Fracture Elevator ..... 68

**BONE**

Blondiau Bone Curette .....194  
 Bone Awl..... 336  
 Bone Graft Driver ..... 336  
 Ginestet Bone Hook ..... 316  
 Lima Bone Curette .....194  
 Ruskin Bone Cutting Forceps.....363  
 Temporal Bone Specimen Holder ..... 304

**BORDURE**

Monopolar Elevator.....267

**BOSSARD**

Cup Forceps-Fenestrated.....353

**BOUCHAYER**

Laryngeal Instrument Set .....216  
 Aspirating/Suction Tube.....216  
 Cup Forceps.....216  
 Cup Forceps, Oval.....216  
 Micro Scissors .....216  
 Alligator Forceps.....216  
 Heart Shape Forceps .....216  
 Lancet Knife .....216  
 Pistol Injector .....216  
 Injection Needle, Bayonet .....216  
 Pistol Needle, Bayonet.....216  
 Freche Monopolar Knife ..... 217  
 Bouchayer Vocal Cord Retractor ..... 217  
 Bouchayer Knife Handle ..... 217  
 Bouchayer Needle Holder ..... 217  
 Monopolar Cable..... 217  
 Bouchayer Instrument Tray ..... 217  
 Laryngeal Instrument Accessories ..... 217  
 Replacement Needle for MCL55..... 217  
 Right Bayonet Injection Needle for MCL55..... 217  
 Left Bayonet Injection Needle for MCL55 ..... 217  
 Replacement Knife Blades for MCL93..... 217  
 Pistol Injector, 10mm ..... 217  
 Microsurgical Elevator ..... 217





Bouchayer Instrument Tray .....	217	<b>CAMO</b>	Dental Splint-Disposable.....	204
Laryngoscope Accessories .....	218	<b>CALIFORNIA EAR INSTITUTE OSSICULOPLASTY SIZER SET</b>	Ossiculoplasty Sizers 2.0mm thru 8.0mm.....	252
Laryngoscope Suspension Apparatus.....	218	Instrument Tray.....	252	
Chest Plate for Suspension Apparatus.....	218	<b>CALIPERS</b>		
Tongue Depressor for Suspension Apparatus.....	218	Austin, Strut Caliper .....	39	
Fiberoptic Light .....	218	Castroviejo Caliper .....	144	
Laryngoscope Set Large .....	218	Cause Measuring Rods (Calipers).....	285	
Bouchayer Laryngoscope, Large .....	218	Charachon Measuring Rods (Calipers).....	285	
Fiberoptic Light .....	218	Dumon Measuring Rods (Calipers).....	285	
Laryngoscope Set Medium .....	218	House Strut Caliper .....	45	
Bouchayer Laryngoscope, Medium.....	218	Measuring Rods (Calipers).....	285	
Fiberoptic Light .....	218	Robier Measuring Rods (Calipers).....	285	
Micro Elevator.....	227	Sauvage Measuring Rod (Caliper).....	286	
<b>BOUCHERON</b>		Vince Measuring Rod (Caliper).....	286	
Speculum Round.....	27	<b>CANNULAS</b>		
<b>BOURGEOIS</b>		Aston-Daniel Endoscopic Cannula.....	140	
Tonsil Forceps.....	196	Daniel Endoscopic Cannula.....	140	
<b>BOWMAN</b>		Lichtwicz Antrum Trocar Needle .....	117	
Lacrimal Probe Stainless Steel .....	152	Ruskin Antrum Trocar Needle .....	117	
<b>BRACKMAN</b>		Sinus Trocar and Cannula .....	117	
Suction Irrigator .....	296	Van Alyea Frontal Sinus Cannula.....	117	
Suction Tube .....	33	Von Eicken Suction Cannulas.....	116	
<b>BRASNU</b>		<b>CANUYT</b>		
Laryngoscope.....	235	Tongue Depressor.....	201	
Suction Tube .....	240	<b>CAPLAN</b>		
<b>BREGEAT</b>		Nasal Bone Scissors Double-Action.....	106	
Scissors .....	329	<b>CARPENTER</b>		
<b>BROPHY</b>		Dissector/Elevator.....	195	
Gum and Suture Scissors .....	153, 330	<b>CARTILAGE</b>		
<b>BROWN</b>		Cartilage and Fascia Press.....	59, 264	
Needle Holder .....	150	Cartilage Round Hook.....	316	
<b>BROWN-ADSON</b>		Cartilage Scissors .....	187, 330	
Tissue Forceps.....	147, 178	Jost Cartilage Crusher .....	264	
<b>BRUENING</b>		Martin Cartilage Cutting Block .....	264	
Septum Forceps .....	72	Teixido Cartilage Cutter .....	265	
Tonsil Snare .....	202	<b>CASIANO</b>		
<b>BRUZZO</b>		Transcervical Laryngeal Injection Medialization Needle Set		
Pick.....	287	.....	232	
<b>BUCK</b>		Needle Handle .....	232	
Ear Currettes .....	6	Transcervical Laryngeal Injection Needle.....	232	
<b>BURRS</b>		Needle Trocar Obturator, Sharp.....	232	
Cutting .....	246	Instrument Tray, One Level.....	232	
Diamond .....	247	<b>CASTROVIEJO</b>		
Drill/Burr .....	248	Caliper .....	144	
Ear Perforating Burr .....	287	Forceps.....	182	
Lemoine Drill/Burr .....	248	Needle Holder .....	150	
Lindemann Drill/Burr .....	248	Suture Forceps .....	16	
Tungsten-Carbide.....	247	<b>CAUSSE</b>		
<b>C</b>		Air Bag.....	204	
<b>CABLES</b>		Ear Knife.....	280, 281	
Bipolar Cables .....	175	Glass Plate .....	254	
Monopolar Cables .....	183	Hook.....	277	
		Instrument Tray.....	254	

Measuring Rods (Calipers).....	285	<b>COLUMELLA</b>	Distance Measuring Rod Forceps .....	286
Suction Irrigator .....	296	<b>COMEG</b>	Telescope Sleeve 2° W/Cleaning Port .....	377
<b>CHABOLLE</b>		Telescope Sleeve 32° W/Cleaning Port .....	377	
Tongue Depressor.....	198	Telescope Sleeve 47° W/Cleaning Port .....	377	
<b>CHAPUT</b>		Telescope Sleeve 72° W/Cleaning Port .....	377	
Tissue Forceps.....	196	<b>CONVERSE</b>		
<b>CHARACHON</b>		Alar Retractor .....	325	
Ear Forceps Tray .....	302	Becker, Converse Scissor .....	329	
Hook.....	277	Double-Edge Scissors .....	153	
Measuring Rods (Calipers).....	285	Dural Scissors.....	106	
Pick.....	287	Guarded Chisel.....	65	
Suction Tube W/Thumb Control.....	300	Nasal Retractor .....	101	
<b>CHATELIER</b>		Rasp.....	98	
Adenoid Forceps .....	196	Scissors .....	187, 330	
<b>CHEEK RETRACTOR</b> .....	100	Skin Hook .....	83	
<b>CHISELS</b>		<b>CORGILL-HARTMAN</b>		
Austin, Chisel .....	39	Ear Forceps .....	10	
Ballenger V-Shaped Chisel .....	65	<b>COTTLE</b>		
Chisel.....	265	Alar Retractor .....	101	
Converse Guarded Chisel.....	65	Chisel.....	65, 311	
Cottle Chisel .....	65, 311	Columella Forceps .....	148	
Derlacki Chisel .....	56	Dorsal Scissors .....	106	
Double Guarded Chisel .....	311	Double Hook .....	83	
Freer Chisel.....	65	Knife Guide and Retractor .....	101	
House Footplate Chisel .....	44	Mallet .....	88	
Jost Chisel .....	311	Nasal Knife.....	86	
Marquet Chisel.....	265	Neivert Retractor .....	101	
Metzenbaum Chisel.....	65	Osteotome.....	91	
“V” Shaped Chisel.....	311	Retractor .....	101	
<b>CHOBAUT</b>		Scissors .....	187, 330	
“Golf Club” Elevator .....	267	Septum Elevator .....	68, 350	
<b>CHOUARD</b>		Septum Speculum .....	112	
Ring .....	190	Skin Elevator .....	68	
<b>CINELLI</b>		Skin Hook .....	83	
Osteotome.....	90	Specula.....	112	
<b>CITELLI</b>		Speculum.....	371	
Punch Forceps .....	353	<b>COTTLE-JOSEPH</b>		
<b>CITELLI-FRECHE</b>		Double Hook .....	83	
Forceps.....	353	<b>COTTLE-MCKENTY</b>		
<b>CLAMPS</b>		Elevator .....	350	
Ossicle Holding Clamp.....	16	<b>COTTLE-PECH</b>		
<b>CLAOUE</b>		Scissors .....	330	
Dissecting Forceps.....	179	<b>COTTON</b>		
Osteotome.....	318	Cotton Applicator .....	242	
Retractor .....	325	<b>CRILE</b>		
Suction Tube and Probe .....	373	Hemostatic Forceps.....	164	
<b>CLIP APPLIERS</b>		<b>CRILE-WOOD</b>		
Clip Applying Forceps.....	354	Needle Holder .....	150, 184	
<b>COAGULATORS</b>		Needle Holder W/Tungsten-Carbide Jaws.....	150	
Ball Tip Coagulator .....	183	<b>CUP FORCEPS</b>		
<b>COAKLEY</b>		Bossard, Cup Forceps, Fenestrated.....	353	
Antrum Curettes .....	67	Cupped Sinus Forceps .....	72	
Sinus Curette Backward .....	67	DeGabor, Laryngeal Cup Forceps W/Cleaning Port .....	358	
Sinus Curette Forward.....	653			



Dessi Universal Cup Forceps .....	355	MOM Curette .....	266
Ear Cup Forceps Delicate .....	10	Moure Adenoid Curettes.....	194
Ear Cup Forceps Extra Long .....	10	Reverse Adenoid Curettes.....	121
Fenestrated Cup Forceps.....	355	Romanet Curette.....	266
Fenestrated Cup Forceps W/Cleaning Port.....	356	Shapleigh Ear Curette.....	7
House Cup Forceps.....	12	Shea Curette .....	54
Jankowski Cup Forceps, Fenestrated .....	357	Sprague Ear Curette.....	7
Jankowski Cup Forceps .....	356, 357	Sterkers Curette .....	267
Jankowski Cup Forceps W/Cleaning Port .....	356	Straight Curette .....	267
Jankowski Heartshaped Cup Forceps.....	357	Stubbs Adenoid Curettes .....	121
Kleinsasser Laryngeal Mini Cup Forceps .....	136	Volkman Curettes .....	174, 311
Kleinsasser Laryngeal Cup Forceps .....	136	<b>CURVED RASP .....</b>	<b>322</b>
Kleinsasser Laryngeal Original Cup Forceps.....	137	<b>CUSHING</b>	
Klossek Cup Forceps, Fenestrated .....	358	Cushing Vein Retractor .....	101
Klossek Cup Forceps W/Suction .....	358	<b>D</b>	
Large Fenestrated Cup Forceps.....	358	<b>DACRYOCYSTORHINOSTOMY</b>	
Laryngeal Biopsy Cup Forceps W/Cleaning Port.....	228	Dacryocystorhinostomy Sickle Knife .....	86
Laryngeal Biopsy Cup Forceps.....	228	<b>DANIEL</b>	
Laryngeal Biopsy Oblong Cup Forceps.....	229	Endoscopic Cannula.....	140
Luc Nasal Cup Forceps .....	359	<b>DARROUZET</b>	
Micro Cupped Forceps.....	275	Speculum.....	294
MicroLaryngeal Cup Forceps .....	136	Suction Irrigation Adapter.....	303
Oval Cup Forceps .....	361	Suction Pump Foot Switch .....	303
Pear-Shaped Cupped Jaw Forceps .....	76	Suction Pump Trumpet Valve .....	303
Rouvier Cup Forceps.....	362	<b>D'ASSUMPCAO</b>	
Rouvier Cup Forceps W/Cleaning Port.....	362	Flap Forceps.....	314
Small Fenestrated Cup Forceps.....	363	<b>DAUPHIN</b>	
Stamm Cup Forceps W/Cleaning Port .....	363	Hypopharyngoscope.....	231
Straight Cup Forceps W/Cleaning Port.....	363	<b>DAUTREY</b>	
<b>CURETTES</b>		Retractor .....	369
Adenoid Curettes (Disposable) .....	120	<b>DAVIS</b>	
Antrum Curette .....	66	Mouth Gag Set.....	124
Barnhill Adenoid Curettes.....	120	Ring Blades .....	125
Blondiau Bone Curette .....	194	<b>DAVIS BOYLE</b>	
Buck Ear .....	6	Dental Splint .....	198
Coakley Antrum Curettes.....	67	Mouth Gag.....	198
Coakley Sinus Curette, Backward .....	67	Tongue Depressor.....	199
Coakley Sinus Curette, Forward .....	67	<b>DAY</b>	
Double-Ended Curette .....	265	Ear Hook .....	17
Ear Curette .....	266	<b>DEAN</b>	
Fenestrated Curette .....	266	Periosteotome.....	8
Freche Sinus Curette.....	349	Tonsil Scissors .....	128
Frontal Sinus Curette.....	67	<b>DEBAKEY-DIETHRICH</b>	
Hough Curette.....	42	Vascular Tissue Forceps .....	181
House Curette .....	43	<b>DÉDO-FRÈCHE</b>	
House-Sheehy Knife Curette.....	46	Laryngoscope.....	234
House Stapes Curette.....	47	<b>DEFOURMENTEL</b>	
Jankowski Sinus Curette .....	349	Breast Markers .....	336
Klossek Curette .....	349	Rasp .....	321
Klossek Curette/Elevator .....	349	Retractor .....	325
LDG Sinus Curette .....	349	<b>DE GABORY</b>	
Lempert Endural Curette.....	7	Laryngeal Cup Forceps W/Cleaning Port .....	358
Lermoyer Adenoid Curette .....	194	Suction Tube Handle .....	376
Lima Bone Curette .....	194		
Middle Ear Curette.....	266		
Middleton Adenoid Curette.....	120		

<b>DENHARDT</b>	
Mouth Gag.....	125
<b>DERF</b>	
Needle Holder.....	151
<b>DERLACKI</b>	
Chisel.....	56
Mobilizer.....	56
Ossicle Holding Clamp.....	16
<b>DESMARRES</b>	
Retractor.....	186, 325
<b>DESSI</b>	
Bipolar Forceps.....	354
Bipolar Forceps Detach.....	354
Scissors W/Cleaning Port.....	370
Suction Irrigation Pump.....	383
Universal Cup Forceps.....	355
<b>DEVEZE</b>	
Speculum.....	294
<b>DIAMOND DUST</b>	
Diamond Dust Rasps, Single-Ended.....	322
<b>DIETER-CHARACHON</b>	
Malleus Nipper.....	272
<b>DILATORS</b>	
Laborde Tracheal Dilator.....	130, 225
Trousseau Tracheal Dilator.....	130
<b>DINGMAN</b>	
Mouth Gag Set.....	125
Periosteal Elevator.....	68
<b>DISSECTORS</b>	
Arcus Marginalis Dissector.....	154
Austin Attic Dissector.....	38
Forehead Orbital Rim Dissector, Half Curved.....	143
Frontotemporal Dissector.....	143
Henke Double-Ended Dissector.....	195
McCabe Flap Knife Dissector.....	48
<b>DISSECTING FORCEPS</b>	
Atraumatic Dissecting Forceps.....	178
Barraya Dissecting Forceps.....	178
Claoue Dissecting Forceps.....	179
Dissecting Forceps.....	179
McCabe Facial Nerve Dissecting Forceps.....	49
Precelli Dissecting Forceps.....	180
Redon Dissecting Forceps.....	197
<b>DISSECTING SCISSORS</b> .....	331
<b>DISSECTORS/ELEVATORS</b>	
Agris-Dingmann Elevator/Dissector.....	312
Carpenter Dissector/Elevator.....	195
Dissector/Elevator.....	350
Elevator/Dissector.....	312
Jost Dissector/Elevator.....	195
<b>DISSECTORS/RETRACTORS</b>	
Hurd Dissector/Pillar Retractor.....	123, 195
Hurd Elevator/Pillar Retractor, Coated.....	195
Morrison-Hurd Dissector and Pillar Retractor.....	123
<b>DIVERTICULOSCOPES</b>	
Esophagosopes and Suctions.....	226
Lacau Diverticuloscope.....	225
Reyt Diverticuloscope.....	225
<b>DOCTORS SPECIALTY TRAYS/SETS</b>	
Abitbol Laser Microlaryngeal Instruments.....	212
Becker Rhinoplasty Instruments.....	310
Benninger Microlaryngeal Instrument Set.....	214
Bouchayer Laryngeal Instrument Set.....	216
Bouchayer Laryngoscope Accessories.....	218
Bouchayer Laryngoscope Set, Large.....	218
Bouchayer Laryngoscope Set, Medium.....	218
California Ear Institute Ossiculoplasty Sizer Set.....	252
Casiano Injection Needle Set.....	232
Duncavage Sphenoid Sinus Instrument Set.....	338
Henry Endoscopic Parathyroid Instrument Set.....	208
House Otology Instrument Set.....	255
J. B. Causse Instrument Tray.....	254
J. B. Causse Middle Ear Instrument Accessories.....	254
J. B. Causse Middle Ear Instrument Set.....	253
Kennedy Frontal Sinus Instrument Set.....	339
Kraus TM MicroCut® Forceps.....	260
Levine Orbital Decompression Instrument Set.....	340
Myringotomy Instrument Set.....	37
Netterville Thyroplasty Instrument Set.....	132
Parsons Accessories.....	341
Parsons Minimally Invasive Sinus Instrument Set.....	341
Sataloff Indirect Laryngeal Instrument Set.....	224
Sataloff Laryngoscopes.....	222
Sataloff Microlaryngeal Instrument Set.....	219
Selesnick Lateral Skull Base Set.....	261
Stamm Skull Base Instrument Set.....	342
Terris Thyroidectomy Accessories.....	210
Terris Thyroidectomy Instrument Set.....	209
Wiet Chronic Ear/Stapes Surgery Instruments.....	263
Vaughan Suction Sinus Instruments.....	343
Wormald Anterior Skull Base and Pituitary Instrument Accessories.....	346
Wormald Anterior Skull Base and Pituitary Instrument Set.....	344
Wormald Frontal Sinus Surgery Instrument Set.....	347
Wormald Hemorrhage Control Set.....	346
Wormald Hemorrhage Control Set Accessories.....	346
<b>DORSAL SCISSORS</b>	
Dorsal Scissors.....	107
Fomon Dorsal Scissor, Tungsten-Carbide.....	107
<b>DOUBLE FIXATION HOOK</b> .....	84
<b>DOUBLE GUARDED CHISEL</b> .....	311
<b>DOYEN</b>	
Mouth Gag.....	199
<b>DRILLS/BURRS</b>	
Drill/Burr.....	248
Hand Drill.....	248
Lemoine Drill/Burr.....	248
Lindemann Drill/Burr.....	248

**DRUM SCRAPER**

Hough Drum Scraper ..... 42

**DUBREUIL**

Elevator ..... 268  
Suction Tube ..... 296

**DUFOURMENTEL**

Retractor ..... 325

**DUMON**

Measuring Rods (Calipers) ..... 285

**DUNCAVAGE**

Sphenoid Sinus Instrument Set ..... 338  
Vertical Cup Forceps ..... 338  
Horizontal Cup Forceps ..... 338  
Vertical Thru-Cut Forceps ..... 338  
Horizontal Thru-Cut Forceps ..... 338  
Blunt Probe ..... 338  
Blunt Probe W/Suction ..... 338  
Freer Elevator ..... 338  
Freer Elevator W/Suction ..... 338  
Instrument Tray ..... 338

**E**

**EAR CHISELS**

Chisel ..... 265  
Marquet Chisel ..... 265

**EAR CUP FORCEPS**

Delicate ..... 10  
Extra Long ..... 10  
House Cup Forceps ..... 12

**EAR CURETTES**

Buck Ear Curettes ..... 6  
Double-Ended Curette ..... 265  
Ear Curette ..... 266  
Fenestrated Curette ..... 266  
House-Sheehy Knife Curette ..... 46  
House Stapes Curette ..... 47  
Lempert Endural Curette ..... 7  
Middle Ear Curette ..... 266  
MOM Curette ..... 266  
Romanet Curette ..... 266  
Shapleigh Ear Curette ..... 7  
Shea Curette ..... 54  
Sprague Ear Curette ..... 7  
Sterkers Curette ..... 267  
Straight Curette ..... 267

**EAR ELEVATORS**

Austin Duckbill Knife Elevator ..... 38  
Austin Footplate Elevator ..... 39  
Austin Knife Elevator ..... 38  
Bayonet Elevator ..... 267  
Bordure Monopolar Elevator ..... 267  
Chobaut “Golf Club” Elevator ..... 267  
Curved Suction Elevator ..... 268  
Dubreuil Elevator ..... 268

Ear Elevator ..... 268  
Fleury Elevator ..... 268  
Garabedian Elevator ..... 269  
Gentine Elevator ..... 269  
Guilford-Wright Drum Elevator ..... 40  
Guilford-Wright Duckbill Elevator ..... 40  
House-Type “Gimmick” Elevator ..... 269  
Klap Elevator ..... 269  
Lempert Elevator ..... 8, 69  
Lerault Elevator ..... 270  
Marquet Elevator ..... 270  
Marquet Elevator, Double-Ended ..... 270  
Paparella Duckbill Elevator ..... 50  
Periosteal ENT Elevator ..... 8  
Plester Elevator ..... 271  
Rosen Elevator ..... 271  
Sebileau Elevator ..... 271, 313  
Sulcus Elevator ..... 271  
Tabb Backhanded Elevator ..... 55  
Thomassin Elevator ..... 271  
Weit Micro Elevator “Golf Club” Elevator ..... 271

**EAR FENESTROMETER**

Paparella Fenestrometer ..... 50

**EAR FORCEPS**

Alligator Forceps, Miniature ..... 9  
Alligator Forceps, Very Fine ..... 9  
Alligator Forceps, Very Fine, Panther ..... 9  
Bellucci Alligator Forceps, Delicate ..... 9  
Corgill-Hartman Ear Forceps ..... 10  
Dieter-Charachon Malleus Nipper ..... 272  
Duckbill Ear Forceps ..... 10  
Ear Cup Forceps, Delicate ..... 10  
Ear Cup Forceps, Extra Long ..... 10  
Ear Forceps, Angled, Very Fine ..... 11  
Ear Forceps, Very Fine ..... 11  
Forehead Grasping Forceps ..... 143  
Frayse Piston Closing Forceps ..... 272  
Goode T-Tube Forceps ..... 58  
Greven Ear Forceps ..... 11  
Hartmann Alligator Micro-Forceps ..... 273  
Hartmann Ear Forceps ..... 11  
Hartmann-Herzfeld Ear Forceps ..... 12  
Hough Crura Nipper Forceps, Very Fine ..... 12  
House Alligator Crimping Forceps ..... 12  
House Cup Forceps ..... 12  
House Miniature Forceps ..... 13  
House Strut Forceps ..... 13  
House-Wullstein Miniature Cup Forceps ..... 13  
Huttenbrink Metallic Piston Closing Forceps ..... 273  
Juers Crimper Forceps, Very Fine ..... 13  
KOS Crimping Forceps ..... 14  
Lubet Barbon Forceps ..... 273  
Lucae Ear Forceps ..... 359  
Marquet Alligator Forceps ..... 274  
McCabe Facial Nerve Dissecting Forceps ..... 49  
McGee Crimping/Closing Forceps ..... 274

McGee Malleus Crimping Forceps.....	14	House-Sheehy Knife Curette.....	46
Micro Alligator Forceps.....	274	House Sickle Knife "Number One Knife".....	46
Micro Alligator Forceps, W/Tube Shaft.....	274	House Tympanoplasty Knife.....	47
Micro-Cupped Forceps.....	275	Jordan Stapedectomy Knife.....	47
Noyes Ear Dressing Forceps.....	14	Josephson Round Knife W/Suction.....	282
Otology and Neurotology Bipolar Forceps.....	275	Jost Lancet Knife.....	282
Piston Closing Forceps.....	275	Lancet Knife.....	282
Schuknecht Wire Crimping Forceps.....	15	Marquet Knife.....	282
Sterkers Alligator Micro-Forceps.....	276	McCabe Canal Knife.....	48
Struempel Ear Forceps, Fine.....	15	McCabe-Culbertson Canal Knife.....	48
Thomassin Alligator Forceps.....	276	McCabe Flap Knife Dissector.....	48
Tobey Ear Forceps.....	15	McHugh Flap Knife.....	49
T-Tube Insertion Forceps.....	276	MOM Flap Knife W/Suction.....	283
<b>EAR GOUGES</b>		MOM Sickle Knife W/Suction.....	283
Fleury Gouges.....	276	Morgon Sickle Knife.....	283
<b>EAR HOLDING CLAMPS</b>		Myringotomy Knife.....	19
Derlacki Ossicle Holding Clamp.....	16	Myringotomy Knife Blade (Disposable).....	19
Sheehy Ossicle Holding Clamp.....	16	Paparella Incudostapedial Joint Knife.....	50
<b>EAR HOOKS</b>		Paparella Sickle Knife.....	51
Allport Incus Hook.....	17	Pick Knife.....	57
Blunt Hook.....	277	Plester Flap Knife.....	283
Causse Hook.....	277	Poltzer Lancet Knife.....	283
Charachon Hook.....	277	Rosen Sickle Knife.....	284
Day Ear Hook.....	17	Royce Ear Knife, Angled.....	19
Footplate Hook.....	278	Royce Ear Knife, Bayonet.....	19
Gillies Skin Hook.....	278	Shea Incision Knife.....	54
Gross Ear Hook and Spoon.....	17	Schuknecht Roller Knife.....	52
House Hook.....	44	Schuknecht Sickle Knife.....	53
Legent Hook.....	278	Sickle Knife.....	87
Lillie Ear Hook.....	17	Sterkers Sickle Knife.....	284
Magnan Hook.....	278	<b>EAR LOOPS</b>	
Marquet Hook.....	279	Billeau Ear Loop.....	20, 284
Paparella-Saunders Hook.....	51	Blunt Ear Loop.....	284
Poncet Hooks.....	279	House Billeau Ear Loop.....	20
Portmann Hooks.....	279	Saint Paul Ear Loop.....	284
Schuknecht Footplate Hook.....	52	Snellen Ear Loop.....	284
Schuknecht Hook.....	53	Traumann Ear Loop.....	285
Shea Fenestrated Hook.....	54	<b>EAR MEASURING RODS (CALIPERS)</b>	
Shea Footplate Hook.....	54	Causse Measuring Rods (Calipers).....	285
Shea Oblique Hook.....	54	Charachon Measuring Rods (Calipers).....	285
Sterkers Hooks.....	279	Dumon Measuring Rods (Calipers).....	285
Tabb Prosthesis Placement Hook.....	55	Measuring Rods (Calipers).....	285
Thomassin Hook.....	280	Robier Measuring Rods (Calipers).....	285
<b>EAR KNIVES</b>		Sauvage Measuring Rod (Caliper).....	286
Causse Ear Knife.....	280, 281	Vince Measuring Rod (Caliper).....	286
Ear Knife.....	280, 281	<b>EAR MIRRORS</b>	
Ear Knife Blade, Single-Use (Disposable).....	18	House Middle Ear Mirror.....	45
Ear Lancet Knife.....	281	Martin Knife/Mirror.....	286
Frayse Lancet Knife.....	281	Zini Mirror.....	286
Ghandi Knife.....	56	<b>EAR MISCELLANEOUS</b>	
Guilford-Wright Flap Knife.....	40	Darrouzet Suction Irrigation Adapter.....	303
Guilford-Wright Sickle Knife.....	40	Darrouzet Suction Pump Foot Switch.....	303
Harrison Knife.....	56	Darrouzet Suction Pump Trumpet Valve.....	303
House Lancet Knife "#2 Knife".....	44	Fascia Press.....	303
House Myringotomy Knife.....	45	Flexible Arm Retractor.....	304

Footprint Press .....	303	Robier Retractor .....	290
Legent Flexible Tension Arm .....	304	Schuknecht Retractor .....	291
Legent Flexible Tension Arm Accessories .....	304	Weitlaner Retractor .....	291
Legent T-Tube Inserter .....	305	Weitlaner Retractor (Baby) .....	291
MOM Ball End Seeker, W/Suction .....	304	Weitlaner-Wullstein Retractor .....	291
Schuknecht Wire Bending Die .....	305	<b>EAR RETRACTORS - SELF RETAINING</b>	
Temporal Bone Specimen Holder .....	305	Bellucci-Wullstein Retractor .....	21
Vent Tube Cutting Block .....	305	Heiss Automatic Skin Retractor .....	21
Vincent Punch .....	305	J. House Vascular Strip Retractor .....	21
<b>EAR NEEDLES</b>		Paparella-Weitlaner Retractor .....	21
Hough Needle .....	41	Perkins Retractor .....	22
House Needle .....	45	Schuknecht-Weitlaner Retractor .....	22
Jordan Needle .....	48	Weitlaner Retractor .....	22
KOS Needle .....	48	Wullstein-Weitlaner Retractor .....	22
Needle, Sharp Point .....	20	<b>EAR RONGEURS</b>	
Paparella Fine Needle .....	50	Beyer Rongeur .....	23
Schuknecht Needle .....	53	Kerrison Mastoid Rongeur .....	23
<b>EAR PERFORATORS</b>		Lempert Rongeur, Heavy Pattern .....	24
Ear Perforator Burr .....	287	Mini Friedman Rongeur .....	23
Middle Ear Perforator .....	287	Ruskin Rongeur .....	24
<b>EAR PERIOSTEOTOME</b>		<b>EAR SCISSORS</b>	
Dean Periosteotome .....	8	Bellucci Scissors, Micro, Black Finish .....	25
<b>EAR PICKS</b>		Bellucci Scissors, Miniature, Fine .....	25
Blunt Pick .....	287	Bellucci Scissors, Very Fine .....	25
Bruzzo Pick .....	287	Fisch Crura Scissors .....	25
Charachon Pick .....	287	House-Bellucci Alligator Scissors, Delicate .....	26
Curved Pick W/Suction .....	288	Micro Scissors .....	293
Ear Picks .....	288	Shea Vein Graft Scissors .....	190, 333
Hough Pick .....	42	Sterkers-Micro Scissors .....	293
Hough Stapedectomy Pick .....	41	<b>EAR SEPARATORS</b>	
House-Barbara Pick .....	43	Ear Separator .....	272
House-Crabtree Dissector Pick .....	43	House Separator .....	46
House Oval Window Pick .....	46	Separator .....	272
House Strut Pick .....	47	<b>EAR SPATULAS</b>	
Legent Monopolar Pick .....	288	Schuknecht Spatula .....	53
Marquet Pick .....	288	<b>EAR SPECULA/SPECULUM</b>	
McGee Footplate Pick .....	49	Boucheron Speculum, Round .....	27
Paparella Whirlybird Pick .....	51	Darrouzet Speculum .....	294
Portmann Handle Pick .....	288	Deveze Speculum .....	294
Rosen Pick .....	52	Diagnostic Ear Speculum (Disposable) .....	295
<b>EAR PROBES</b>		Ear Speculum, Oval Oblique, Black Finish .....	30
Marquet Ball Tip Probe .....	289	Farrior Speculum, Oval .....	28
Sterkers Ball Tip Probe .....	289	Farrior Speculum, Oval Oblique .....	28
Tenotome Probe .....	289	Farrior Speculum, Round .....	27
<b>EAR RASPATORIES</b>		Gruber Speculum, Oval .....	29
Ear Raspatory .....	268	Gruber Speculum, Round .....	28
<b>EAR RASPS</b>		Hartmann Speculum, Oval .....	29
Marquet Rasp .....	289	Hartmann Speculum, Round .....	29
Stenstrom Rasp .....	289	Legent Diagnostic Ear Speculum .....	294
<b>EAR RETRACTORS</b>		Legent Otoscope .....	294
Angot-Vanecloo Retractor .....	290	Le Mee Diagnostic Ear Speculum .....	295
Beckman-Weitlaner Retractor .....	290	Toynbee Speculum, Round .....	30
Bizeau Retractor .....	290	<b>EAR SPECULUM HOLDERS</b>	
Mondain Retractor .....	290	Shea Speculum Holder .....	31
Plester Retractor .....	291	Universal Speculum Holder .....	30



**EAR SUCTION TUBES/ACCESSORIES**

Barnes Suction Tube ..... 32  
 Baron Suction Tube ..... 32  
 Bellucci Suction Tube ..... 33  
 Brackman Suction Irrigator ..... 296  
 Brackman Suction Tube ..... 33  
 Causse Suction Irrigator ..... 296  
 Charachon Suction Tube W/Thumb Control ..... 300  
 Dubreui Suction Tube ..... 296  
 Ferguson-Frazier Suction Tube, Angled ..... 33, 115  
 Ferguson-Frazier Suction Tube, Strong Angle ..... 33, 115  
 Fraysse Suction Tube W/Luer Lock ..... 296  
 Frazier Suction Tube ..... 34  
 Guilford-Wright Suction Tube ..... 34  
 House-Baron Suction Tube ..... 35  
 House Cutoff Suction Adapter ..... 34  
 House Suction Adapter ..... 297  
 House Suction Irrigator ..... 35  
 House Suction Tube ..... 300  
 Kahn-Frazier Suction Tube ..... 35  
 Lempert Suction Tube ..... 297  
 Luer-Lock Adapter ..... 301  
 Maspétiol Suction Tube ..... 297, 298  
 McGee Suction Tube ..... 35  
 MicroLite Suction Needles (Disposable) ..... 32  
 Microsurgery Suction Tube ..... 297  
 Rosen Suction Tube ..... 36  
 Rosen-Type Suction Cannula ..... 298  
 Schuknecht Suction Tube ..... 36  
 Sterker Suction Irrigator ..... 298  
 Suction Cannula ..... 299  
 Suction Handle W/Bypass Control (Disposable) ..... 32  
 Suction Irrigation Tube ..... 299  
 Suction Irrigator ..... 299  
 Suction Tube Handle ..... 300  
 Suction Tube with Finger Control ..... 300  
 Thomassin Suction Tube ..... 298  
 Turning Adapter Luer Lock ..... 301  
 Wertheimer Suction Tube ..... 297  
 Zimmermann Suction Tube W/Luer Lock ..... 301

**EAR SYRINGE**

Ear Syringe, Metal ..... 58  
 Ear Syringe Tip ..... 58  
 ENT 5cc Syringe with Luer-Lock ..... 191

**EAR TRAYS/ACCESSORIES**

Charachon Ear Forceps Tray ..... 302  
 Instrument Holder Insert ..... 302  
 Otology Instrument Tray ..... 302  
 Plastic Otology Tray ..... 61  
 Stainless Steel Tray ..... 302  
 Thomassin Tray Insert ..... 302

**EAR WORK TABLES**

Hubbard Worktable W/Bracket ..... 31  
 Worktable Ossicle Holding Clamp ..... 31  
 Worktable Piston Trimming Gauge ..... 31

Worktable Set ..... 31

**ELEVATORS**

Austin Duckbill Knife Elevator ..... 38  
 Austin Footplate Elevator ..... 39  
 Austin Knife Elevator ..... 38  
 Ball Elevator ..... 68  
 Bayonet Elevator ..... 267  
 Boies Nasal Fracture Elevator ..... 68  
 Bordure Monopolar Elevator ..... 267  
 Bouchayer Micro Elevator ..... 227  
 Chobaut “Golf Club” Elevator ..... 267  
 Cottle Septum Elevator ..... 68, 350  
 Cottle Skin Elevator ..... 68  
 Cottle-Mckenty Elevator ..... 350  
 Curved Suction Elevator ..... 268  
 Dingman Periosteal Elevator ..... 68  
 Dissector/Elevator, Double-Ended ..... 350  
 Dubreuil Elevator ..... 268  
 Ear Elevator ..... 268  
 Fleury Elevator ..... 268  
 Forehead Elevator, Half Curved ..... 143  
 Freer Septum Elevator ..... 68, 174  
 Garabedian Elevator ..... 269  
 Gentine Elevator ..... 269  
 Gillies Zygoma Elevator ..... 69  
 Goldman Displacer Septum Elevator ..... 69  
 Gorney Septum Suction Elevator ..... 69  
 Guillen Suction Tube-Elevator ..... 350  
 Herman Elevator ..... 350  
 House Elevator ..... 69  
 House-Type “Gimmick” Elevator ..... 269  
 Howarth Elevator ..... 350  
 Joseph Periosteal Elevator ..... 69, 351  
 Klap Elevator ..... 269  
 Lempert Elevator ..... 8, 69  
 Lerault Elevator ..... 270  
 Marquet Elevator ..... 270  
 Marquet Elevator, Double-Ended ..... 270  
 McCollough Elevator ..... 70  
 McKenty Periosteal Elevator ..... 70  
 Netterville Double-Ended Elevator ..... 133  
 Netterville Long Elevator ..... 133  
 Obwegeser Flat Periosteal Elevator ..... 249  
 Obwegeser-Tessier Flat Periosteal Elevator ..... 249  
 Pariteal Periosteal Elevator ..... 144  
 Periosteal ENT Elevator ..... 8  
 Perouse Micro Elevator ..... 227  
 Pennington Elevator ..... 70  
 Pierce Elevator ..... 70  
 Plastic Surgery Elevator ..... 312  
 Plester Elevator ..... 271  
 Prades Elevator ..... 351  
 Rosen Elevator ..... 271  
 Rouvier Suction Tube-Elevator ..... 351  
 Sataloff Thyroplasty Elevator ..... 138  
 Sebileau Elevator ..... 271, 313

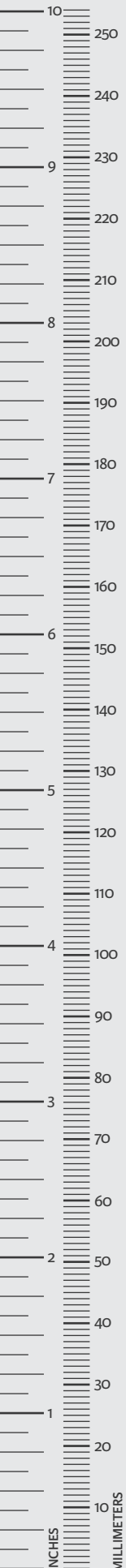

Slamia Breast Elevator.....	313	Kaye Dissecting Scissors, Fine .....	156
Stenstrom Elevators .....	313	Kaye Facelift Scissors.....	156
Suction Tube-Elevator .....	351	Kaye Facelift Scissors, W/Tungsten-Carbide Blades...156	
Sulcus Elevator.....	271	Knapp Strabismus Scissors.....	156
Tabb Backhanded Elevator .....	55	Lahey Dissecting Scissors.....	157
Thomassin Elevator .....	271	Lister Bandage Scissors .....	157
Trelat Elevators.....	313	Little Suture Carrying Scissors .....	157
Weit Micro Elevator “Golf Club” Elevator .....	271	Mayo Scissors, Beveled Blades.....	157
Woodson Elevator .....	70	Mayo Scissors, W/Tungsten-Carbide Blades.....	158
Zygomatic Arch Elevator .....	70	Metzenbaum Scissors, Delicate.....	158
<b>ELEVATORS/DISSECTORS</b>		Metzenbaum Scissors, W/Tungsten-Carbide Blades .158	
Agris-Dingmann Elevator/Dissector .....	312	Operating Scissors .....	159
Carpenter Dissector/Elevator .....	195	Plastic Surgery Scissors .....	159
Elevator/Dissector .....	312	Scissors, Spring Handle .....	159
Henke Double-Ended Dissector .....	195	Stevens Stitch Scissors .....	160
Jost Dissector/Elevator .....	195	Stevens Stitch Scissors, Ribbon Type.....	160
<b>ELEVATORS/RETRACTORS</b>		Stevens Tenotomy Scissors .....	160
Hurd Elevator/Pillar Retractor.....	195	<b>ENDOPLASTIC WIRE CUTTERS</b>	
Hurd Elevator/Pillar Retractor, Coated.....	195	Becker Wire Scissors, W/Tungsten-Carbide Blades .....	
<b>ENDOPLASTIC KNIVES/HANDLES</b>		.....	161, 187, 329
Knife Handle.....	149	Guilford-Wright Wire Cutting Scissors .....	161
Knife Handle, Corwin .....	149	Universal Wire Suture Scissors .....	162
Rosen Cartilage Knife.....	149	<b>ENDOSCOPIC PLASTIC SURGERY INSTRUMENTS</b>	
<b>ENDOPLASTIC NEEDLE HOLDERS</b>		Arcus Marginalis Dissector .....	143
Brown Needle Holder.....	150	Forehead Elevator, Half Curved.....	143
Castroviejo Needle Holder .....	150	Forehead Grasping Forceps .....	143
Crile-Wood Needle Holder .....	149, 184	Forehead Orbital Rim Dissector, Half Curved.....	144
Crile-Wood Needle Holder, W/Tungsten-Carbide Jaws.....	149	Forehead Scissors .....	143
Derf Needle Holder .....	151	Forehead Suction Elevator.....	144
Halsey Needle Holder, W/Tungsten-Carbide Jaws .....	151	Frontotemporal Dissector.....	143
Mayo-Hegar Needle Holder, W/Tungsten-Carbide Jaws.....	151	Parietal Periosteal Elevator .....	144
Olsen-Webster Needle Holder/Scissors, W/Tungsten-Carbide Jaws.....	151	Periosteal Spreader.....	144
Ryder Needle Holder, W/Tungsten-Carbide Jaws .....	152	<b>ENT</b>	
Webster Needle Holder .....	152	ENT Elevator.....	8
Webster Needle Holder, W/Tungsten-Carbide Jaws ..	152	ENT 5cc Syringe with Luer-Lock.....	191
<b>ENDOPLASTIC PROBES</b>		<b>EVE</b>	
Bowman Lacrimal Probe, Stainless Steel .....	152	Tonsil Snare .....	128
<b>ENDOPLASTIC SCISSORS</b>		<b>EXCAVATORS</b>	
Baby Metzenbaum Scissors.....	152	Austin Excavator .....	38
Brophy Gum and Suture Scissors.....	152, 330	Hough Excavator .....	41
Converse Double-Edge Scissors .....	152	House Excavator .....	44
Fomon Dorsal Scissors .....	107, 152	Schuknecht Whirlybird Excavator .....	53
Forehead Scissors .....	153	<b>F</b>	
Freeman Rhytidectomy Scissors.....	153	<b>FARABEUF</b>	
Gorney Plastic Surgery Scissors.....	153	Raspatory .....	324
Iris Scissors, Large Finger Rings, Sharp/Sharp.....	154	Retractors .....	186
Iris Scissors, Sharp/Blunt.....	154	<b>FARRELL</b>	
Iris Scissors, Sharp/Sharp .....	153, 154	Applicator .....	64
Iris Scissors, “Supercut”.....	155	<b>FARRIOR</b>	
Iris Scissors, Sure-Grip, W/Tungsten-Carbide Blades	155	Speculum Oval .....	28
Joseph Scissors .....	155	Speculum Oval Oblique .....	28
Joseph Scissors, Double Edge .....	155	Speculum, Round.....	27

**FAURE**

Fenestrated Forceps .....355  
 Sinus Scissors..... 370  
 Suction Tube .....373

**FENESTROMETER**

Paparella Fenestrometer ..... 50

**FERGUSON-FRAZIER**

Suction Tube Angled .....33, 115  
 Suction Tube Strong Angle.....33, 115

**FERRIS-SMITH**

Sponge/Fragment Forceps ..... 121

**FIBEROPTICS**

Abitbol Fiberoptic Light Source.....213

**FISCH**

Crura Scissors.....25

**FISHER**

Tonsil Knife .....123

**FIXATION HOOK**

Double Fixation Hook ..... 84

**FLEURY**

Elevator ..... 268  
 Gouges ..... 276

**FLEXIBLE ARM**

Flexible Arm Retractor .....304

**FOERSTER**

Sponge Forceps.....166

**FOMON**

Dissecting Scissors.....107  
 Dorsal Scissors .....107, 153  
 Dorsal Scissor, W/Tungsten-Carbide Jaws.....107  
 Lower Lateral Scissors..... 108  
 Rasp ..... 98  
 Rasp Double-Ended.....322  
 Rasp Single-Ended .....322  
 Retractor .....102  
 Saber Back Scissors .....108  
 Scissors .....331

**FOOTPLATE**

Austin Footplate Hook ..... 39  
 Footplate Hook ..... 278  
 Hough Footplate Pick..... 40, 41  
 Hough Stapedial Footplate Auger ..... 42  
 House Footplate Chisel ..... 44  
 McGee Footplate Pick ..... 49

**FORCEPS**

Adson-Tubiana Forceps, Delicate.....180  
 Adson Bipolar Forceps..... 175  
 Adson Dressing / Tissue Forceps ..... 178  
 Adson Dressing Forceps.....145  
 Adson Hemostatic Forceps.....164  
 Adson Monopolar Forceps.....182  
 Adson Tissue Forceps, Delicate..... 147  
 Adson Tissue Forceps, W/Tungsten-Carbide Jaws .....146  
 Adson Tissue Forceps..... 147

Alligator Forceps, Miniature ..... 9  
 Alligator Forceps, Very Fine, Panther ..... 9  
 Alligator Forceps, Very Fine ..... 9  
 Allis-Coakley Tonsil Forceps..... 121  
 Allis Haemostatic Forceps, Delicate ..... 181  
 Allis Tissue Forceps.....164  
 Asch Septum Straightening Forceps ..... 71  
 Atraumatic Dissecting Forceps ..... 178  
 Babcock Tissue Forceps .....164  
 Backbiting Forceps, Rotatable ..... 352  
 Backbiting Forceps ..... 352  
 Backhaus Towel Forceps .....166, 181  
 Barraya Dissecting Forceps..... 178  
 Bellucci Alligator Forceps, Delicate ..... 9  
 Biopsy and Grasping Forceps, Long..... 71  
 Biopsy and Grasping Forceps ..... 71  
 Bipolar Coagulating Forceps, Insulated ..... 175, 210  
 Bipolar Electrode ..... 352  
 Bipolar Jewelers Forceps ..... 315  
 Birket Tonsil Seizing Forceps .....196  
 Bishop-Harmon Dressing Forceps ..... 147  
 Bishop-Harmon Tissue Forceps ..... 147  
 Blakesley Forceps, Thru-Cut..... 72  
 Blakesley Forceps-Fenestrated .....353  
 Blakesley Forceps..... 352  
 Blakesley Nasal Suction Forceps, Thru-Cut.....81  
 Blakesley Septum Forceps ..... 71  
 Bossard Cup Forceps-Fenestrated .....353  
 Bourgeois Tonsil Forceps .....196  
 Brown-Adson Tissue Forceps ..... 147, 178  
 Bruening Septum Forceps..... 72  
 Castroviejo Forceps .....182  
 Castroviejo Suture Forceps..... 147  
 Chaput Tissue Forceps .....196  
 Chatelier Adenoid Forceps .....196  
 Citelli-Freche Forceps.....353  
 Citelli Punch Forceps .....353  
 Claoue Dissecting Forceps ..... 179  
 Clip-Applying Forceps.....354  
 Corgill-Hartman Ear Forceps .....10  
 Cottle Columella Forceps .....148  
 Crile Hemostatic Forceps.....164  
 Cupped Sinus Forceps..... 72  
 D'Assumpcao Flap Forceps ..... 314  
 DeBakey-Diethrich Vascular Tissue Forceps ..... 181  
 De Gabory Laryngeal Cup Forceps, W/Cleaning Port 358  
 Dessi Bipolar Forceps, Detach .....354  
 Dessi Bipolar Forceps .....354  
 Dessi Universal Cup Forceps .....355  
 Dieter-Charachon Malleus Nipper ..... 272  
 Dissecting Forceps..... 179  
 Dressing Forceps-Serrated ..... 179  
 Dressing Forceps.....148  
 Duckbill Ear Forceps .....10  
 Ear Cup Forceps, Delicate .....10  
 Ear Cup Forceps, Extra Long .....10





Ear Forceps, Angled, Very Fine .....	11	Kocher Forceps.....	177
Ear Forceps, Very Fine.....	11	KOS Crimping Forceps .....	14
Faure Fenestrated Forceps .....	355	Kraus TM MicroCut® Forceps .....	260
Fenestrated Cup Forceps .....	355	Large Fenestrated Cup Forceps.....	358
Fenestrated Cup Forceps W/Cleaning Port.....	356	Laryngeal Alligator Forceps, W/Cleaning Port .....	227
Ferris-Smith Sponge/Fragment Forceps .....	121	Laryngeal Biopsy Cup Forceps, W/Cleaning Port.....	228
Foerster Sponge Forceps .....	166	Laryngeal Biopsy Cup Forceps .....	228
Forceps W/Teeth .....	314	Laryngeal Biopsy Forceps .....	227
Frayss Piston Closing Forceps .....	272	Laryngeal Biopsy Oblong Cup Forceps .....	229
Frontal Recess Forceps .....	355	Laryngeal Bipolar Forceps.....	229
Giraffe Frontal Sinus Recess Forceps, Thru-Cut.....	73	Laryngeal Crocodile Forceps .....	229
Giraffe Frontal Sinus Recess Forceps.....	73	Laryngeal Forceps, W/Cleaning Port .....	230
Goode T-Tube Forceps.....	58	Laryngeal Micro Bipolar Forceps, W/Cleaning Port...	230
Graefe Fixation Forceps .....	148	Leriche Hemostatic Forceps .....	177
Greven Ear Forceps .....	11	Lewis Septum Forceps.....	75
Gruenwald-Jansen Bayonet Forceps.....	74	Lubet Barbon Forceps .....	273, 359
Gruenwald Clean-Bite Forceps.....	73	Lucae Ear Forceps .....	359
Gruenwald Nasal Bayonet Forceps .....	74	Lucae Nasal Dressing Bayonet Forceps.....	76
Gruenwald Nasal Forceps, Modified Jaws.....	74	Luc Nasal Cup Forceps .....	359
Gruenwald Nasal Forceps, Thru-Cut .....	74	Luc Nasal Spoon Forceps .....	359
Halstead Micro Mosquito Forceps.....	176	Lusk MicroBite™ Forceps.....	360
Halstead Mosquito Forceps.....	164, 176	Magnan Bipolar Forceps .....	175
Hartmann Alligator Micro-Forceps.....	273	Marie Nerve Dissecting Forceps .....	196
Hartmann Ear Forceps.....	11	Marquet Alligator Forceps .....	274
Hartmann Mosquito Forceps .....	165	Martel Flap Grasping Forceps.....	182
Hartmann-Herzfeld Ear Forceps .....	12	Martin Bone Cutting Forceps .....	196
Heart Tip Forceps.....	182	McCabe Facial Nerve Dissecting Forceps .....	49
Heuwieser Antrum Grasping Forceps.....	75	McGee Crimping/Closing Forceps.....	274
Hildyard Post-Nasal Biopsy Forceps .....	75	McGee Malleus Crimping Forceps.....	14
Hough Crura Nipper Forceps, Very Fine.....	12	McIndoe Forceps .....	180
House-Wullstein Miniature Cup Forceps.....	13	MeroPack Insertion Forceps .....	76
House Alligator Crimping Forceps.....	12	Micro-Cupped Forceps.....	275
House Cup Forceps .....	12	Micro Alligator Forceps, W/Tube Shaft .....	274
House Miniature Forceps .....	13	Micro Alligator Forceps.....	274
House Strut Forceps .....	13	Micro Backbiting Forceps .....	96
Huttenbrink Metallic Piston Closing Forceps.....	273	Micro Dissecting Forceps.....	314
Jackson Alligator Grasping Forceps .....	140	Micro Mosquito Forceps .....	165
Jako Microlaryngeal Alligator Forceps .....	135	Mini-Struycken Through-Cutting Forceps .....	360
Jako Microlaryngeal Cup Forceps .....	135	Mixer Forceps, Pediatric .....	165
Jankowski Cup Forceps, Fenestrated.....	357	Monopolar Coagulating Forceps, Insulated .....	183
Jankowski Cup Forceps .....	356, 357	Negus Tonsil Seizing Forceps.....	197
Jankowski Cup Forceps W/Cleaning Port.....	356	Non-Perforating Towel Forceps .....	166
Jankowski Heartshaped Cup Forceps .....	357	Noyes Ear Dressing Forceps.....	14
Jansen-Middleton Forceps.....	357	Noyes Nasal Dressing Forceps .....	76
Jansen-Middleton Septum Forceps .....	75	O'Shaughnessy Tonsil Seizing Forceps .....	197
Jewelers Forceps .....	148, 315	Ombredanne Towel Forceps.....	181
Josephine Terrier Punch Forceps.....	357	Orsel Maxillary Forceps.....	361
Juers Crimper Forceps, Very Fine .....	13	Otology and Neurotology Bipolar Forceps.....	275
Kelly Artery Forceps.....	165, 176	Oval Cup Forceps .....	361
Kleinsasser Laryngeal Mini Cup Forceps.....	136	Pean Forceps.....	177
Kleinsasser Laryngeal Mini Forceps.....	136	Pear-Shaped Cupped Jaw Forceps .....	76
Kleinsasser Microlaryngeal Alligator Forceps .....	136	Peynegre Punch Forceps, W/Cleaning Port .....	361
Kleinsasser Microlaryngeal Cup Forceps .....	136	Piston Closing Forceps.....	275
Kleinsasser Original Cup Forceps.....	137	Pitanguy Small Flap Demarcator.....	314
Klossek Cup Forceps, Fenestrated .....	358	Politzer Forceps.....	361
Klossek Cup Forceps, W/Suction .....	358	Portmann Tonsil Seizing Forceps .....	197

Potts-Smith Tissue Forceps .....	148	Forehead Orbital Rim Dissector, Half Curved.....	143, 144
Prades Alligator Forceps .....	362	Forehead Scissors .....	143, 144
Precelli Dissecting Forceps .....	180	Forehead Suction Elevator.....	143, 144
Punch Biopsy Forceps, Thru-Cut .....	76	<b>FOX</b>	
Real Tissue Forceps.....	180	Scissors .....	187
Redon Dissecting Forceps.....	197	<b>FRAYSSE</b>	
Rochester-Ocshner Artery Forceps .....	165	Lancet Knife.....	281
Rochester-Pean Artery Forceps.....	166	Piston Closing Forceps.....	272
Roeder Towel Forceps .....	166	Suction Tube W/Luer Lock.....	296
Rouvier Alligator Forceps.....	362	<b>FRAZIER</b>	
Rouvier Cup Forceps.....	362	Skin Hook .....	84
Rouvier Cup Forceps W/Cleaning Port .....	362	Suction Irrigation System .....	373
Rouvier Punch Forceps.....	362	Suction Tube .....	34
Ruskin Bone Cutting Forceps.....	363	Suction Tube Medium Angle.....	116
Schmidt-Boettcher Tonsil Forceps.....	122	<b>FRECHE</b>	
Schmidt Tonsil Forceps .....	122	Monopolar Knife.....	367
Schmidt Tonsil Seizing Forceps.....	197	Monopolar Suction Tube .....	367
Schuknecht Wire Crimping Forceps .....	15	Sinus Curette .....	349
Servant Desepidermiser Pince Forceps.....	314	<b>FREDRICH</b>	
Skinner Maxillary Biopsy Forceps .....	77	Sickle Knife .....	366
Small Fenestrated Cup Forceps .....	363	<b>FREEMAN</b>	
St. Claire Thompson Adenoid Forceps .....	122	Face Lift Retractor.....	326
Stamm Cup Forceps, W/ Cleaning Port .....	363	Flap Retractor.....	326
Sterkers Alligator Micro-Forceps .....	276	Rhytidectomy Scissors.....	154
Straight Cup Forceps, W/ Cleaning Port .....	363	<b>FREER</b>	
Struempel Ear Forceps, Fine .....	15	Chisel.....	65
Struempel-Lusk Nasal Suction Forceps, Pediatric.....	81	Hook/Retractor.....	102
Struempel-Voss Forceps .....	77	Septum Elevator .....	68, 174
Struempel Pediatric Forceps.....	77	Septum Knife.....	86
Stryucken Turbinate Forceps.....	77	<b>FRONTAL OSTIUM SEEKER</b> .....	93
T-Tube Insertion Forceps.....	276	<b>FRONTAL RECESS FORCEPS</b> .....	355
Takahashi Nasal Forceps .....	78	<b>G</b>	
Takahashi Nasal Suction Forceps.....	82	<b>GARABEDIAN</b>	
Terrier Forceps.....	177	Elevator .....	269
Tessier Disimpaction Forceps.....	249	Laryngoscope.....	235
Tessier Dissecting Forceps.....	249	Needle Holder Insert Only.....	243
Thomassin Alligator Forceps .....	276	Suction Tube .....	240
Thru-Cut Forceps.....	72, 73, 74, 76, 80, 81, 360	Needle Holder, W/Tungsten-Carbide Jaws.....	242
Thru-Flow Nasal Suction Forceps.....	82	<b>GARCIN</b>	
Tissue Forceps 1 x 2 Teeth.....	179	Laryngoscope Small .....	234
Tissue Forceps.....	148	<b>GENTINE</b>	
Tobey Ear Forceps .....	15	Elevator .....	269
Walsham Septum Straightening Forceps.....	78	<b>GERZOG</b>	
Watson Williams Nasal Polyp Forceps.....	79	Mallet .....	88
Weil-Blakesley Forceps, Thru-Cut .....	80	<b>GHANDI</b>	
Weil-Blakesley Forceps .....	363	Ghandi Knife.....	56
Weil-Blakesley Nasal Suction Forceps .....	81, 82	<b>GILBERT O'BRIEN</b>	
Weil-Blakesley Sinus Forceps .....	79, 80	Approximator .....	242
Weil Nasal Forceps.....	79	<b>GILLIES</b>	
White Tonsil Forceps .....	122	Skin Hook .....	278
Wilde Dressing Forceps, Delicate .....	80	Zygoma Elevator .....	69
Wormald Anterior Skull Base Clip-Appling Forceps	364		
Wormald Bipolar Forceps with Suction.....	365		
<b>FOREHEAD</b>			
Forehead Elevator, Half Curved.....	143, 144		
Forehead grasping Forceps.....	143, 144		

<b>GINESTET</b>	
Bone Hook .....	316
<b>GIRAFFE</b>	
Giraffe Frontal Sinus Recess Forceps, Thru-Cut.....	73
Giraffe Frontal Sinus Recess Forceps.....	73
<b>GLABELLA</b>	
Rasp, W/Tungsten-Carbide Teeth.....	98
<b>GOLDMAN</b>	
Displacer Septum Elevator .....	69
Knife Guide and Retractor .....	103
Septum Scissors.....	108
<b>GOODE</b>	
T-Tube Forceps .....	58
<b>GOODYEAR</b>	
Uvula Retractor .....	127
<b>GORNEY</b>	
Plastic Surgery Scissors .....	154
Rake Retractor.....	326
Rasp Double-Ended.....	322
Septum Suction Elevator .....	69
Turbinates Scissors.....	108
<b>GOUGES</b>	
Fleury Gouges .....	276
Killian Septum Gouge .....	315
Parkes Hump Gouge.....	83
“V” Shaped Gouge.....	315
<b>GRAEFE</b>	
Fixation Forceps.....	148
<b>GREVEN</b>	
Ear Forceps .....	11
<b>GROSS</b>	
Ear Hook and Spoon.....	17
<b>GROOVED DIRECTOR.....</b>	190
<b>GRUBER</b>	
Speculum Oval.....	29
Speculum Round.....	28
<b>GRUENWALD</b>	
Clean-Bite Forceps.....	73
Nasal Bayonet Forceps .....	74
Nasal Forceps Modified Jaws.....	74
Nasal Forceps Thru-Cut .....	74
<b>GRUENWALD-JANSEN</b>	
Bayonet Forceps.....	74
<b>GUERRIER</b>	
Hook.....	204
Tonsil Scissors.....	202
<b>GUIDES</b>	
House Wire Strut Guide .....	47
<b>GUILFORD-WRIGHT</b>	
Drum Elevator .....	40
Duckbill Elevator.....	40
Flap Knife .....	40
Footplate Pick .....	40
Sickle Knife.....	40
Stapes Pick .....	40
Suction Tube .....	34
Wire Cutting Scissors.....	161
<b>GUILLEN</b>	
Suction Tube-Elevator .....	350, 373
<b>H</b>	
<b>HAJEK-KOFFLER</b>	
Antrum Punch .....	94
Punch Thru-Cut .....	96
Sphenoid Punch Rotating.....	96
<b>HALLE</b>	
Nasal Speculum .....	112
<b>HALSEY</b>	
Needle Holder .....	184
Needle Holder, W/Tungsten-Carbide Jaws.....	151
<b>HALSTEAD</b>	
Micro Mosquito Forceps .....	176
Mosquito Forceps .....	164, 176
<b>HANDLES</b>	
Beaver Knife Handle .....	292
Corwin Knife Handle .....	149, 292
Endoplastic Knife Handle .....	148
E/Z Chuck Blade Handle .....	18
Laryngeal Modular Handle .....	230
Laryngeal Sickle Knife Handle.....	233
Lite-Touch Uni-Handle .....	18
Papon Endoscopic Tube Handle.....	210
Papon Telescope Holder .....	210
Poltzer Lancet Knife Handle .....	283
Suction Tube Handle .....	300
Swan-Morton Scalpel Handle .....	292
<b>HARRISON</b>	
Harrison Knife .....	56
<b>HARTMANN</b>	
Alligator Micro-Forceps .....	273
Ear Forceps .....	11
Mosquito Forceps .....	165
Nasal Speculum .....	113
Speculum .....	371
Speculum Oval.....	29
Speculum Round.....	29
Tuning Forks .....	59
<b>HARTMANN-HERZFELD</b>	
Ear Forceps .....	12
<b>HEAD AND NECK FORCEPS</b>	
Bipolar Coagulating Forceps, Insulated .....	210
<b>HEAD AND NECK HANDLES</b>	
Papon Endoscopic Tube Handle.....	210
Papon Telescope Holder .....	210
<b>HEART TIP</b>	
Heart Tip Forceps.....	182
<b>HEAVY NEEDLE</b>	
Paparella Heavy Needle .....	50

<b>HEISS</b>	
Automatic Skin Retractor .....	21
<b>HENKE</b>	
Double-Ended Dissector .....	195
<b>HENRY</b>	
Endoscopic Parathyroid Instrument Set .....	208
Blunt Trocar, 3.00mm .....	208
Monopolar Grasping Forceps .....	208
Monopolar Alligator Forceps .....	208
Monopolar Scissors, Axial .....	208
Monopolar Coagulating Hook .....	208
Blunt Probe .....	208
Trocar Ring .....	208
Monopolar Cable .....	208
Medium Instrument Tray .....	208
<b>HERMAN</b>	
Knife/Elevator .....	350
Monopolar Hook .....	367
<b>HEUWIESER</b>	
Antrum Grasping Forceps .....	75
<b>HEYMANN-KLOSSEK</b>	
Scissors .....	188, 331
<b>HILDYARD</b>	
Post-Nasal Biopsy Forceps .....	75
<b>HOLDING CLAMPS</b>	
Derlacki Ossicle Holding Clamp .....	16
Sheehy Ossicle Holding Clamp .....	16
<b>HOOKS</b>	
Allport Incus Hook .....	17
Austin Footplate Hook .....	39
Blunt Hook .....	277
Causse Hook .....	277
Charachon Hook .....	277
Converse Skin Hook .....	83
Cottle-Joseph Double Hook .....	83
Cottle Double Hook .....	83
Cottle Skin Hook .....	83
Day Ear Hook .....	17
Double Fixation Hook .....	84
Footplate Hook .....	278
Frazier Skin Hook .....	84
Freer Hook/Retractor .....	102
Gillies Skin Hook .....	278
Ginestet Bone Hook .....	316
Gross Ear Hook and Spoon .....	17
Guerrier Hook .....	204
House Hook .....	44
Humby Double Hook .....	316
Johnson Skin Hook .....	84
Joseph Skin Hook .....	84
Kleinert-Kutz Skin Hook .....	85
Large Tendon Hook .....	316
Laryngeal Hook .....	230
Legent Hook .....	278
Lillie Ear Hook .....	17
Magnan Hook .....	278
Marquet Hook .....	279
Millard Double Hook .....	85
Paparella-Saunders Hook .....	51
Poncet Hooks .....	279
Portmann Hooks .....	279
Round Cartilage Hook .....	316
Shea Fenestrated Hook .....	54
Shea Footplate Hook .....	54
Shea Oblique Hook .....	54
Schuknecht Footplate Hook .....	52
Schuknecht Hook .....	53
Sisson Nerve Hook .....	85
Sterkers Hooks .....	279
Tabb Prosthesis Placement Hook .....	55
Thomassin Hook .....	280
<b>HOUGH</b>	
Curette .....	42
Drum Scraper .....	42
Excavator .....	41
Footplate Pick .....	41
Knife "Small Weapon" .....	42
Needle .....	41
Pick .....	42
Stapedectomy Pick .....	41
Stapedial Footplate Auger .....	42
Whirlybird Knife .....	41
<b>HOUGH CRURA</b>	
Nipper Forceps Very Fine .....	12
<b>HOUGH-SAUNDERS</b>	
Stapes Hoe .....	43
<b>HOUSE</b>	
Alligator Crimping Forceps .....	12
Barbara Pick .....	43
Billeau Ear Loop .....	20
Crabtree Dissector Pick .....	43
Cup Forceps .....	12
Curettes .....	43
Cutoff Suction Adapter .....	34
Cutting Block .....	58
Elevator .....	69
Elevator "Gimmick" .....	44
Excavator .....	44
Footplate Chisel .....	44
Gelfoam Press .....	59
Hook .....	44
Incudostapedial Joint Knife .....	44
Lancet Knife "#4 Knife" .....	44
Middle Ear Mirror .....	45
Miniature Forceps .....	13
Myringotomy Knife .....	45
Needle .....	45
Otology Instrument Set .....	255
Sickle Knife .....	255
Footplate Hook .....	255

Hook, 90° .....	255
Plester Flat Micro Knife.....	255
Curette Angled, Double-Ended .....	255
Hook, Ball Tip.....	255
Hook, Blunt, 45° .....	255
Beckman Retractor .....	255
Hartmann Alligator Ear Forceps.....	255
Micro Cupped Forceps .....	255
Rouvier Elevator & Knife .....	255
Dieters Malleus Nipper .....	255
Rosen Knife, 135° .....	255
Needle, Slightly Curved .....	255
Micro Scissors.....	255
Oval Window Pick.....	46
Pick .....	46
Separator .....	46
Sheehy Knife Curette.....	46
Sickle Knife “Number One Knife” .....	46
Stapes Curette.....	47
Strut Calipers .....	45
Strut Forceps .....	13
Strut Pick .....	47
Suction Adapter .....	297
Suction Irrigator .....	35
Suction Tube .....	300
Tympanoplasty Knife.....	47
Wire Strut Guide .....	47
<b>HOUSE-BARON</b>	
Suction Tube .....	35
<b>HOUSE-BELLUCCI</b>	
Alligator Scissors Delicate.....	26
<b>HOUSE-DIETERS</b>	
Malleus Nipper.....	26
<b>HOUSE-WULLSTEIN</b>	
Miniature Cup Forceps .....	13
<b>HOWARTH</b>	
Elevator.....	350
<b>HUBBARD</b>	
Worktable W/Bracket.....	31
<b>HUMBY</b>	
Double Hook .....	316
<b>HURD</b>	
Dissector/Pillar Retractor .....	123
Elevator/Pillar Retractor .....	195
Elevator/Pillar Retractor, Coated .....	195
<b>HUTTENBRINK</b>	
Metallic Piston Closing Forceps.....	273
Suction Tube .....	241
<b>HYPOPHARYNGOSCOPES</b>	
Dauphin Hypopharyngoscope .....	231
Hypopharyngoscope.....	231

**I**

**INJECTORS**

Casiano Transcervical Laryngeal Injection	
Medialization Needle.....	232
Injection Needle, Malleable .....	232
Lee-Ahn Injection Needle Sheath.....	139
Oro-Tracheal Laryngeal Injector Needles .....	139
Oro-Tracheal Laryngeal Injector Set.....	139

**INSTRUMENT TRAYS/ACCESSORIES**

Causse Instrument Tray .....	254
Charachon Ear Forceps Tray.....	302
Instrument Holder Insert.....	302
Instrument Tray, Laryngeal Forceps.....	140
Laryngeal Instrument Tray.....	139
Laryngoscope Tray.....	170
Mustard Table .....	170
Nasal and Sinus Instrument Trays.....	118
Netterville Instrument Tray .....	133
One-Level Tray .....	167
Otology Instrument Tray.....	302
Otology Tray Set .....	60, 170
Pick Tray, Plastic.....	169
Pick Tray.....	61
Plastic Otology Tray.....	61
Small Instrument Tray .....	167
Stainless Steel Tray .....	302
Thomassin Tray Insert .....	302
Three-Level Modular Tray.....	169
Three-Level Tray .....	60, 169
Two-Level Tray .....	61, 168

**IRIS**

Scissors .....	109
Scissors Large Finger Rings Sharp/Sharp .....	155
Scissors Sharp/Blunt .....	155
Scissors Sharp/Sharp .....	154, 155
Scissors “Supercut” .....	156
Scissors Sure-Grip, W/Tungsten Carbide Blades .....	156

**J**

**JACKSON**

Alligator Grasping Forceps .....	140
----------------------------------	-----

**JAKO**

Laryngeal Probes .....	135
Microlaryngeal Alligator Forceps.....	135
Microlaryngeal Cup Forceps.....	135
Microlaryngeal Knives.....	135
Microlaryngeal Scissors .....	135

**JANKOWSKI**

Cup Forceps.....	356, 357
Cup Forceps Fenestrated .....	357
Cup Forceps W/Cleaning Port .....	356
Heartshaped Cup Forceps.....	357
Sinus Curette.....	349
Sinus Scissors W/Cleaning Port .....	370

Suction Tube .....	373	Dissector/Elevator .....	195
Suction Tube, W/Bulbus Tip .....	374	Lancet Knife.....	282
<b>JANSEN-MIDDLETON</b>		Retractor .....	327
Forceps .....	357	<b>JUERS</b>	
Septum Forceps .....	75	Crimper Forceps Very Fine.....	13
<b>J. B. CAUSSE</b>		<b>K</b>	
Middle Ear Instrument Accessories .....	254	<b>KAHN-FRAZIER</b>	
Middle Ear Instrument Set .....	253	Suction Tube .....	35, 116
Measuring Instrument .....	253	<b>KAWAMOTO</b>	
Hartmann Alligator Forceps .....	253	Osteotome.....	318
Graduated Prosthesis Cutting Block .....	253	<b>KAYE</b>	
Dieters Malleus Nipper .....	253	Dissecting Scissors Fine.....	157
Micro Scissors .....	253	Facelift Scissors.....	157
Instrument Tray.....	253	Facelift Scissors, W/Tungsten-Carbide Blades.....	157
Canal Knife .....	253	<b>KELLY</b>	
Bone Curette .....	253	Artery Forceps .....	165, 176
Incudostapedial Joint Knife .....	253	<b>KENNEDY</b>	
Pick, Curved .....	253	Frontal Sinus Instrument Set .....	339
Forceps, Fine Cupped, Piston .....	253	Malleable, Blunt Probe, Round .....	339
Vein Preparation Plate, 1.0mm .....	253	Malleable, Sharp Knife .....	339
Hook, Perpendicular, Short .....	253	Malleable Hook, Vertical .....	339
Pick, Curved, Semi-Sharp .....	253	Malleable Hook, Back .....	339
Elevator.....	253	Malleable Suction, 6FR.....	339
Martin Vein Press .....	253	Malleable Curette, 2.0mm Cup .....	339
Instrument Tray .....	254	Instrument Tray, One Level.....	339
<b>JENNINGS</b>		<b>KERRISON</b>	
Mouth Gag.....	125, 199	Mastoid Rongeur .....	23, 104
<b>JEWELERS</b>		<b>KERRISON-COSTEN</b>	
Jewelers Bipolar Forceps .....	315	Rongeur .....	104
Jewelers Forceps .....	147, 315	<b>KIDNEY BOWL</b> .....	191
<b>J. HOUSE</b>		<b>KILLIAN</b>	
Vascular Strip Retractor .....	21	Nasal Speculum .....	371
<b>JOHNSON</b>		Nasal Speculum W/Fiberoptics.....	371
Skin Hook .....	84	Septum Gouge .....	315
<b>JORDAN</b>		Septum Specula .....	113
Needle.....	48	<b>KILNER</b>	
Stapedectomy Knife .....	47	Mouth Gag.....	199
<b>JOSEPH</b>		Retractor .....	327
Button End Knife .....	87, 317	Tongue Depressor .....	199
Nasal Knife.....	87	<b>KILNER-JOST</b>	
Nasal Saw.....	87	Scissors .....	332
Periosteal Elevator .....	69, 351	<b>KING</b>	
Rasp .....	369	Adenoid Punch.....	126
Retractor (Skin Hook).....	326	<b>KLAP</b>	
Scissors .....	156, 188, 331	Elevator .....	269
Scissors Double Edge .....	156	<b>KLEINERT-KUTZ</b>	
Skin Hook .....	84	Skin Hook .....	85
<b>JOSEPHINE TERRIER</b>		<b>KLEINSASSER</b>	
Punch Forceps .....	357	Laryngeal Mini Cup Forceps .....	136
<b>JOSEPHSON</b>		Laryngeal Mini Forceps .....	136
Round Knife W/Suction.....	282	Microlaryngeal Alligator Forceps.....	136
<b>JOST</b>		Microlaryngeal Cup Forceps.....	136
Cartilage Crusher.....	264		
Chisel.....	311		

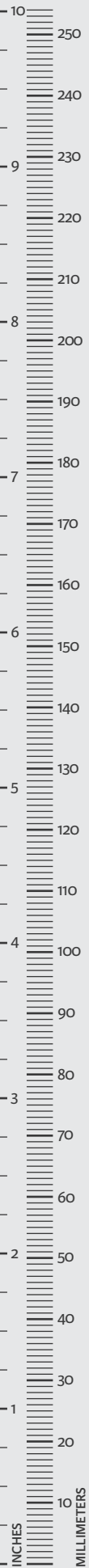



Microlaryngeal Scissors.....	137	Monopolar Knife.....	205
Original Cup Forceps.....	137	Morgon Sickle Knife.....	283
<b>KLOSSEK</b>		Myringoplasty Knife.....	57
Cup Forceps Fenestrated.....	358	Myringotomy Knife.....	19
Cup Forceps W/Suction.....	358	Myringotomy Knife Blade (Disposable).....	19
Curette.....	349	Paparella Incudostapedial Joint Knife.....	50
Curette/Elevator.....	349	Paparella Sickle Knife.....	51
Nails.....	248	Pick Knife.....	57
<b>KNAPP</b>		Plester Flap Knife.....	283
Retractor.....	102	Rosen Cartilage Knife.....	149
Strabismus Scissors.....	109, 157	Rosen Sickle Knife.....	284
<b>KNIVES</b>		Royce Ear Knife, Angled.....	19
Austin Sickle Knife.....	39	Royce Ear Knife, Bayonet.....	19
Ballenger Swivel Knife.....	86, 366	Ruault Sickle Knife.....	205
Blitzer Laryngeal Knives (Disposable).....	138	Sataloff Sharp Knife.....	224
Cause Ear Knife.....	280, 281	Sataloff Sickle Knife.....	224
Cottle Nasal Knife.....	86	Shea Incision Knife.....	54
Dacryocystorhinostomy Sickle Knife.....	86	Schuknecht Roller Knife.....	52
Ear Knife.....	280, 281	Schuknecht Sickle Knife.....	53
Ear Lancet Knife.....	281	Sickle Knife.....	87
Fisher Tonsil Knife.....	123	Sterkers Sickle Knife.....	284
Flap Knife.....	57	Whirlybird Knife.....	41
Fraysse Lancet Knife.....	281	<b>KNIGHT</b>	
Fredrich Sickle Knife.....	366	Nasal Scissors.....	109
Freer Septum Knife.....	86	<b>KOCHER</b>	
Ghandi Knife.....	56	Forceps.....	177
Guilford-Wright Flap Knife.....	40	<b>KOS</b>	
Guilford-Wright Sickle Knife.....	40	Crimping Forceps.....	14
Harrison Knife.....	56	Needle.....	48
Hough Knife "Small Weapon".....	42	<b>KRAUSE</b>	
House Incudstapedial Joint Knife.....	44	Nasal Snare.....	111
House Lancet Knife "#4 Knife".....	44	Snare Wire Pre-Shaped.....	203
House Myringotomy Knife.....	45	<b>KRAUS TM</b>	
House-Sheehy Knife Curette.....	46	MicroCut® Forceps.....	260
House Sickle Knife "Number One Knife".....	46	MicroCut® Forceps 90° Up-Biting.....	260
House Tympanoplasty Knife.....	47	MicroCut® Forceps Forward-Biting.....	260
Jako Microlaryngeal Knives.....	135	MicroCut® Forceps Backward-Biting.....	260
Jordan Stapedectomy Knife.....	47	<b>L</b>	
Joseph Button End Knife.....	87, 317	<b>LABORDE</b>	
Joseph Nasal Knife.....	87	Tracheal Dilator.....	130, 225
Josephson Round Knife W/Suction.....	282	<b>LACAU</b>	
Jost Lancet Knife.....	282	Diverticuloscope.....	225
Lancet Knife.....	282	<b>LAFORCE</b>	
Laryngeal.....	134	Adenotomes.....	120
Laryngeal Sickle Knife.....	233	<b>LAHEY</b>	
Maltz Cartilage Knife.....	87	Dissecting Scissors.....	158
Marquet Knife.....	282	<b>LAKESIDE</b>	
McCabe Canal Knife.....	48	Nasal Scissors.....	109
McCabe-Culbertson Canal Knife.....	48	<b>LARYNGEAL DILATORS</b>	
McCabe Flap Knife Dissector.....	48	Laborde Tracheal Dilator.....	130, 225
McHugh Flap Knife.....	49	Trousseau Tracheal Dilator.....	130
Microsurgery Knife.....	233		
MOM Flap Knife W/Suction.....	283		
MOM Sickle Knife W/Suction.....	283		
Monopolar Cautery Knife.....	205		

**LARYNGEAL DIVERTICULOSCOPIES**

Esophagosopes and Suctions ..... 226  
 Lacau Diverticuloscope ..... 225  
 Reyt Diverticuloscope ..... 225

**LARYNGEAL ELEVATORS**

Bouchayer Micro Elevator.....227  
 Perouse Micro Elevator .....227

**LARYNGEAL FORCEPS**

DeGabory Laryngeal Cup Forceps W/Cleaning Port.. 358  
 Jako Microlaryngeal Alligator Forceps ..... 135  
 Jako Microlaryngeal Cup Forceps ..... 135  
 Kleinsasser Laryngeal Mini Cup Forceps.....136  
 Kleinsasser Laryngeal Mini Forceps.....136  
 Kleinsasser Microlaryngeal Alligator Forceps .....136  
 Kleinsasser Microlaryngeal Cup Forceps .....136  
 Kleinsasser Original Cup Forceps.....137  
 Laryngeal Alligator Forceps, W/Cleaning Port .....227  
 Laryngeal Biopsy Cup Forceps ..... 228  
 Laryngeal Biopsy Cup Forceps, W/Cleaning Port..... 228  
 Laryngeal Biopsy Forceps .....227  
 Laryngeal Biopsy Oblong Cup Forceps ..... 229  
 Laryngeal Bipolar Forceps.....229  
 Laryngeal Crocodile Forceps ..... 229  
 Laryngeal Forceps, W/Cleaning Port ..... 230  
 Laryngeal Micro Bipolar Forceps, W/Cleaning Port... 230

**LARYNGEAL HANDLES**

Laryngeal Modular Handle..... 230

**LARYNGEAL HOOKS**

Laryngeal Hook..... 230

**LARYNGEAL HYPOPHARYNGOSCOPIES**

Dauphin Hypopharyngoscope ..... 231  
 Hypopharyngoscope..... 231

**LARYNGEAL INJECTORS**

Casiano Transcervical Laryngeal Injection  
 Medialization Needle..... 232  
 Injection Needle, Malleable ..... 232  
 Lee-Ahn Injection Needle Sheath.....139  
 Oro-Tracheal Injector Cannula .....139  
 Oro-Tracheal Laryngeal Injector Set.....139

**LARYNGEAL KNIVES/HANDLES**

Jako Microlaryngeal Knives ..... 135  
 Laryngeal .....134  
 Laryngeal Sickle Knife.....233  
 Laryngeal Sickle Knife Holder .....233  
 Microsurgery Knife .....233

**LARYNGEAL MIRRORS**

Laryngeal Mirrors ..... 123

**LARYNGEAL MISCELLANEOUS**

Aston-Daniel Endoscopic Cannula .....140  
 Cotton Applicator ..... 242  
 Daniel Endoscopic Cannula.....140  
 Garabedian Needle Holder, W/ Tungsten-Carbide Jaws  
 ..... 242  
 Garabedian Needle Holder Insert Only ..... 243  
 Gilbert O'Brien Approximator ..... 242

Instrument Tray, Laryngeal Forceps.....140  
 Jackson Alligator Grasping Forceps .....140  
 Laryngoscope Tray.....140  
 Mustard Table .....140  
 Parsons Laryngeal Sprinkler..... 242  
 Perous Needle Holder Insert Only ..... 243

**LARYNGEAL MOUTH GAGS AND BLADES**

Moriniere Mouth Gag Set..... 238

**LARYNGEAL PROBES**

Lowinger Laryngeal Probe..... 239  
 Jako Laryngeal Probes ..... 135

**LARYNGEAL RETRACTORS**

Retractor..... 239

**LARYNGEAL SCISSORS**

Kleinsasser Microlaryngeal Scissors ..... 137  
 Jako Microlaryngeal Scissors..... 135  
 Micro Scissors ..... 239  
 Woo Laryngeal Scissors ..... 239

**LARYNGEAL SUCTION TUBES/ACCESSORIES**

Brasnu Suction Tube..... 240  
 Garabedian Suction Tube..... 240  
 Huttenbrink Suction Tube ..... 241  
 Laryngeal ..... 116, 134  
 Monopolar Suction Tube ..... 240  
 Suction Tube Cannula ..... 240, 241

**LARYNGOSCOPIES**

Abitbol Laryngoscope ..... 212  
 Articulated Laryngoscope ..... 213  
 Brasnu Laryngoscope.....235  
 Dédo-Frèche Laryngoscope ..... 234  
 Garabedian Laryngoscope.....235  
 Garcin Laryngoscope, Small..... 234  
 Lacau Diverticuloscope ..... 225  
 Laryngoscope..... 213  
 Laryngoscope, 4 Channels .....235  
 Laryngoscope, Extra Small ..... 234  
 Laryngoscope, Small ..... 234, 235  
 Legent Laryngoscope..... 236  
 Pignat Laryngoscope ..... 236  
 Reyt Diverticuloscope ..... 225

**LATHBURY**

Applicator ..... 64

**LDG**

Sinus Curette ..... 349

**LECOUTEUR**

Tongue Depressor.....201

**LEE-AHN**

Injection Needle Sheath ..... 139

**LEGENT**

Diagnostic Ear Speculum..... 294  
 Flexible Tension Arm .....304, 384  
 Flexible Tension Arm Accessories ..... 304  
 Hook..... 278  
 Laryngoscope..... 236

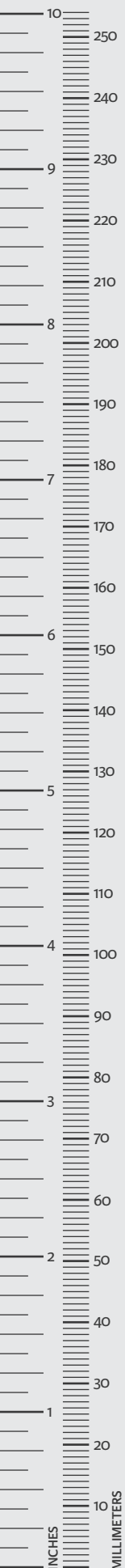



Monopolar Pick.....	288	<b>LITETOUCH</b>	
Otoscope .....	294	Uni-Handle .....	18
T-Tube Inserter .....	305	<b>LITTLER</b>	
<b>LEGER</b>		Suture Carrying Scissors.....	158
Scissors .....	332	<b>LOMBARD</b>	
<b>LE MEE</b>		Mallet .....	317
Diagnostic Ear Speculum.....	295	<b>LONG</b>	
Tongue Depressor w/Suction.....	201	Elevator .....	133
<b>LEMOINE</b>		Long Backhanded Elevator (TABB) .....	55
Drill/Burr .....	248	<b>LOOPS</b>	
Nails.....	248	Billeau Ear Loop .....	20, 284
<b>LEMPERT</b>		Blunt Ear Loop.....	284
Elevator .....	8, 69	House Billeau Ear Loop .....	20
Endural Curette .....	7	Loop and Ball End Retractor .....	327
Raspatory.....	312	Saint Paul Ear Loop .....	284
Rongeur Heavy Pattern .....	24, 105	Snellen Ear Loop .....	284
Suction Tube .....	297	Traumann Ear Loop.....	285
<b>LERAULT</b>		<b>LOVE</b>	
Elevator .....	270	Nerve Root Retractor .....	102
<b>LERICHE</b>		Uvula Retractor .....	127
Hemostatic Forceps.....	177	<b>LOWINGER</b>	
<b>LERMOYER</b>		Laryngeal Probe .....	239
Adenoid Curette.....	194	<b>LUBET</b>	
Snare Wire Pre-Shaped .....	203	Barbon Forceps .....	273
<b>LEROUX ROBERT</b>		Forceps.....	359
Retractor .....	202	<b>LUC</b>	
<b>LEVINE</b>		Nasal Cup Forceps .....	359
Orbital Decompression Instrument Set.....	340	Nasal Spoon Forceps .....	359
Ring with Suction .....	340	<b>LUCAE</b>	
Knife .....	340	Ear Forceps .....	359
Suction Pick .....	340	Mallet .....	88
Suction Curette.....	340	Nasal Dressing Bayonet Forceps .....	76
Sickle Knife.....	340	<b>LUER-LOCK</b>	
Forceps, 45°.....	340	Adapter .....	232, 301
Curette Dissector.....	340	<b>LUSK</b>	
Perforator Elevator .....	340	MicroBite™ Forceps .....	360
Instrument Tray.....	340	<b>M</b>	
<b>LEWIS</b>		<b>MAGNAN</b>	
Septum Forceps .....	75	Bipolar Forceps.....	175
<b>LICHTWICZ</b>		Hook .....	278
Antrum Trocar Needle.....	117	<b>MALLETS</b>	
<b>LIGHT SOURCES</b>		Copper Head Mallet .....	88
Olympus Fiberoptic Light Source Adapter .....	237	Cottle Mallet.....	88
Storz Fiberoptic Light Source Adapter.....	237	Gerzog Mallet.....	88
Wolf Fiberoptic Light Source Adapter.....	237	Lombard Mallet.....	317
<b>LILLIE</b>		Lucae Mallet .....	88
Ear Hook .....	17	Mallet, W/Nylon Heads.....	88
<b>LIMA</b>		Mallet .....	317
Bone Curette.....	194	Mead Mallet .....	89
<b>LINDEMENN</b>		Square Head Mallet .....	317
Drill/Burr .....	248	<b>MALTZ</b>	
<b>LISTER</b>		Cartilage Knife .....	87
Bandage Scissors .....	158		

Rasps Single-Ended.....	322
<b>MARCHAC</b>	
Osteotome.....	319
<b>MARIE</b>	
Nerve Dissecting Forceps.....	196
<b>MARQUET</b>	
Alligator Forceps.....	274
Ball Tip Probe.....	289
Chisel.....	265
Elevator.....	270
Elevator Double-Ended.....	270
Hook.....	279
Knife.....	282
Pick.....	288
Rasp.....	289
<b>MARTEL</b>	
Flap Grasping Forceps.....	182
<b>MARTIN</b>	
Bone Cutting Forceps.....	196
Cartilage Cutting Block.....	264
Knife/Mirror.....	286
<b>MASPETIOL</b>	
Suction Tube.....	297, 298
<b>MASSON</b>	
Mouth Gag with Tongue Depressor.....	200
<b>MAXILLARY</b>	
Maxillary Ostium Seeker.....	93
Parsons Maxillary Seeker.....	369
<b>MAXILLOFACIAL DRILLS/BURRS</b>	
Cutting.....	246
Diamond.....	247
Drill/Burr.....	248
Hand Drill.....	248
Lemoine Drill/Burr.....	248
Lindemenn Drill/Burr.....	248
Tungsten-Carbide.....	247
<b>MAXILLOFACIAL ELEVATORS</b>	
Obwegeser Flat Periosteal Elevator.....	249
Obwegeser-Tessier Flat Periosteal Elevator.....	249
<b>MAXILLOFACIAL FORCEPS</b>	
Tessier Disimpaction Forceps.....	249
Tessier Dissecting Forceps.....	249
<b>MAXILLOFACIAL MISCELLANEOUS</b>	
Obwegeser Mandibular Awl.....	250
<b>MAXILLOFACIAL NAILS</b>	
Klossek Nails.....	248
Lemoine Nails.....	248
<b>MAXILLOFACIAL OSTEOTOMES</b>	
Tessier Osteotome.....	249
<b>MAXILLOFACIAL RETRACTORS</b>	
Obwegeser Channel Retractor.....	250
Obwegeser Soft Tissue Retractor.....	250
<b>MAXILLOFACIAL SCISSORS</b>	
Tessier Dissecting Scissors.....	250
<b>MAYO</b>	
Scissors Beveled Blades.....	158
Scissors, W/Tungsten-Carbide Blades.....	159
<b>MAYO HEGAR</b>	
Needle Holder.....	185
Needle Holder, W/Tungsten-Carbide Jaws.....	151
<b>McCABE</b>	
Canal Knife.....	48
Culbertson Canal Knife.....	48
Facial Nerve Dissecting Forceps.....	49
Flap Knife Dissector.....	48
Perforation Rasp.....	49
<b>McCOLLOUGH</b>	
Elevator.....	70
<b>McGEE</b>	
Crimping/Closing Forceps.....	274
Footplate Pick.....	49
Malleus Crimping Forceps.....	14
Oval Window Rasp.....	49
Suction Tube.....	35
<b>McHUGH</b>	
Flap Knife.....	49
<b>McINDOE</b>	
Forceps.....	180
Osteotome.....	320
<b>McIVOR</b>	
Mouth Gag Set.....	126
<b>McKENTY</b>	
Periosteal Elevator.....	70
Sphenoid Punch Thru-Cut.....	96
<b>MEAD MALLET</b>	89
<b>MEASURING RODS (CALIPERS)</b>	
Cause Measuring Rods (Calipers).....	285
Charachon Measuring Rods (Calipers).....	285
Columella Distance Measuring Rod Forceps.....	286
Dumon Measuring Rods (Calipers).....	285
Measuring Rods (Calipers).....	285
Robier Measuring Rods (Calipers).....	285
Sauvage Measuring Rod (Caliper).....	286
Vince Measuring Rod (Caliper).....	286
<b>MELTZER</b>	
Meltzer Adenoid Punch.....	126
<b>MERO PACK INSERTION FORCEPS</b>	76
<b>METZENBAUM</b>	
Chisels.....	65
Scissors.....	128
Scissors, Delicate.....	159
Scissors, Standard.....	189
Scissors, W/Tungsten-Carbide Blades.....	158
<b>MICRO</b>	
Micro Alligator Forceps.....	274
Micro Alligator Forceps, W/Tube Shaft.....	274
Micro Backbiting Forceps.....	96
Micro Dissecting Forceps.....	314

Micro Mosquito Forceps .....	176	<b>MORSELIZERS</b>	
Micro Scissors, Spring Handle .....	332	Rubin Septum Morselizer .....	89
<b>MICROLARYNGEAL</b>		Rubin Septum Morselizer, Guard .....	89
Microlaryngeal Alligator Forceps.....	136	<b>MOURE</b>	
Microlaryngeal Cup Forceps.....	136	Adenoid Curette with Basket.....	194
Microlaryngeal Scissors.....	137	Adenoid Curette without Basket .....	194
Microsurgery Knife .....	233	Shears.....	205
<b>MICROLITE</b>		<b>MOUTH GAGS AND BLADES</b>	
Suction Needle .....	32	Accessory - Palatine Blade for 7803C .....	200
<b>MIDDLETON</b>		April Oral Stabilizer.....	198
Adenoid Curette.....	120	Davis Boyle Mouth Gag.....	198
<b>MILLARD</b>		Davis Boyle Tongue Depressor.....	199
Double Hook .....	85	Davis Mouth Gag Set.....	124
<b>MINI FRIEDMAN</b>		Davis Ring Blades.....	125
Rongeur .....	23, 104	Denhardt Mouth Gag .....	125
<b>MINI-STRUYCKEN</b>		Dingman Mouth Gag Set .....	125
Thru-Cut Forceps.....	360	Doyen Mouth Gag .....	199
<b>MIRRORS</b>		Jennings Mouth Gag.....	125, 199
House Middle Ear Mirror .....	45	Kilner Mouth Gag .....	199
Laryngeal Mirrors .....	123	Masson Mouth Gag with Tongue Depressor .....	200
Martin Knife/Mirror.....	286	McIvor Mouth Gag Set.....	126
Zini Mirror .....	286	Moriniere Mouth Gag Set.....	238
<b>MISCELLANEOUS</b>		Oral Stabilizer .....	124
Mixer Forceps, Pediatric .....	165	Seamann Seiffert Mouth Gag.....	200
Mole Breast Tensor .....	336	<b>MUSTARD TABLE</b> .....	130, 140
<b>MOM</b>		<b>MYRINGOTOMY</b>	
Ball End Seeker W/Suction .....	304	Myringotomy Instrument Set .....	37
Curette .....	266	House Mini Forceps.....	37
Flap Knife W/Suction.....	283	Buck Ear Curette .....	37
Sickle Knife W/Suction.....	283	Billeau Ear Loop .....	37
<b>MONDAIN</b>		Barbara Pick.....	37
Retractor .....	290	Ear Speculum .....	37
<b>MONOPOLAR</b>		Baron Suction Tubes .....	37
Adson Monopolar Forceps.....	182	Instrument Tray.....	37
Apfelbaum Monopolar Suction Tube .....	367	<b>MYRINGOPLASTY</b>	
Bordure Monopolar Elevator.....	267	Myringoplasty Knife .....	57
Freche Monopolar Knife .....	367	<b>N</b>	
Freche Monopolar Suction Tube.....	367	<b>NAILS</b>	
Herman Monopolar Hook.....	367	Klossek Nails .....	248
Legent Monopolar Pick.....	288	Lemoine Nails.....	248
Monopolar Ball Tip Coagulator.....	183	<b>NASAL CANNULAS</b>	
Monopolar Cables .....	183	Von Eicken Suction Cannulas.....	116
Monopolar Cautery Knife .....	205	<b>NASAL CURETTES</b>	
Monopolar Coagulating Forceps, Insulated .....	183	Antrum Curette .....	66
Monopolar Knife.....	205	Coakley Antrum Curettes.....	67
Monopolar Suction Tube .....	368	Coakley Sinus Curette, Backward .....	67
Rouvier Monopolar Knife, W/Suction .....	368	Coakley Sinus Curette, Forward .....	67
Rouvier Monopolar Knife.....	368	Frontal Sinus Curette.....	67
<b>MORGON</b>		<b>NASAL CHISELS</b>	
Sickle Knife .....	283	Ballenger V-Shaped Chisel .....	65
<b>MORINIERE</b>		Converse Guarded Chisel.....	65
Mouth Gag Set.....	238	Cottle Chisel .....	65
<b>MORRISON-HURD</b>		Freer Chisel .....	65
Dissector and Pillar Retractor .....	123		

Metzenbaum Chisel.....	65	Watson Williams Nasal Polyp Forceps.....	79
<b>NASAL ELEVATORS</b>		Weil-Blakesley Forceps, Thru-Cut .....	80
Ball Elevator.....	68	Weil-Blakesley Nasal Suction Forceps .....	81, 82
Boies Nasal Fracture Elevator.....	68	Weil-Blakesley Sinus Forceps .....	79, 80
Cottle Septum Elevator.....	68, 350	Weil Nasal Forceps.....	79
Cottle Skin Elevator.....	68	Wilde Dressing Forceps, Delicate .....	80
Dingman Periosteal Elevator.....	68	<b>NASAL GOUGES</b>	
Freer Septum Elevator.....	68, 174	Parkes Hump Gouge.....	83
Gillies Zygoma Elevator .....	69	<b>NASAL HOOKS</b>	
Goldman Displacer Septum Elevator .....	69	Converse Skin Hook.....	83
Gorney Septum Suction Elevator .....	69	Cottle Double Hook.....	83
House Elevator.....	69	Cottle-Joseph Double Hook .....	83
Joseph Periosteal Elevator .....	69, 351	Cottle Skin Hook.....	83
Lempert Elevator .....	8, 69	Double Fixation Hook .....	84
McCollough Elevator.....	70	Frazier Skin Hook.....	84
McKenty Periosteal Elevator .....	70	Johnson Skin Hook .....	84
Pennington Elevator.....	70	Joseph Skin Hook.....	84
Pierce Elevator .....	70	Kleinert-Kutz Skin Hook .....	85
Woodson Elevator .....	70	Millard Double Hook .....	85
Zygomatic Arch Elevator .....	70	Sisson Nerve Hook .....	85
<b>NASAL FORCEPS</b>		<b>NASAL KNIVES</b>	
Asch Septum Straightening Forceps .....	71	Ballenger Swivel Knife.....	86
Biopsy and Grasping Forceps .....	71	Cottle Nasal Knife .....	86
Biopsy and Grasping Forceps, Long.....	71	Dacryocystorhinostomy Sickle Knife .....	86
Blakesley Forceps, Thru-Cut.....	72	Freer Septum Knife .....	86
Blakesley Nasal Suction Forceps, Thru-Cut.....	81	Joseph Button End Knife .....	87
Blakesley Septum Forceps .....	71	Joseph Nasal Knife.....	87
Bruening Septum Forceps.....	72	Maltz Cartilage Knife.....	87
Cupped Sinus Forceps.....	72	Sickle Knife .....	87
Frontal Recess Forceps .....	355	<b>NASAL MALLETS</b>	
Giraffe Frontal Sinus Recess Forceps .....	73	Copper Head Mallet .....	88
Giraffe Frontal Sinus Recess Forceps, Thru-Cut.....	73	Cottle Mallet.....	88
Gruenwald Clean-Bite Forceps.....	73	Gerzog Mallet.....	88
Gruenwald-Jansen Bayonet Forceps.....	74	Lucae Mallet .....	88
Gruenwald Nasal Bayonet Forceps .....	74	Mallet, W/Nylon Heads.....	88
Gruenwald Nasal Forceps, Modified Jaws.....	74	Mead Mallet .....	89
Gruenwald Nasal Forceps, Thru-Cut .....	74	<b>NASAL MORSELIZERS</b>	
Heuwieser Antrum Grasping Forceps.....	75	Rubin Septum Morselizer .....	89
Hildyard Post-Nasal Biopsy Forceps .....	75	Rubin Septum Morselizer, Guard .....	89
Jansen-Middleton Septum Forceps .....	75	<b>NASAL NEEDLES</b>	
Lewis Septum Forceps.....	75	Sinus Septum Needle, Angled Shaft .....	90
LUC Nasal Spoon Forceps.....	359	Sinus Septum Needle, Bayonet Shaft.....	90
Lucae Nasal Dressing Bayonet Forceps .....	76	<b>NASAL NEEDLE HOLDERS</b>	
MeroPack Insertion Forceps .....	76	Parell Needle Holder, W/Tungsten-Carbide Jaws.....	89
Noyes Nasal Dressing Forceps .....	76	<b>NASAL OSTEOTOMES</b>	
Pear-Shaped Cupped Jaw Forceps .....	76	Anderson-Neivert Osteotome .....	90
Punch Biopsy Forceps, Thru-Cut .....	76	Cinelli Osteotome.....	90
Skinner Maxillary Biopsy Forceps .....	77	Cottle Osteotome .....	91
Struempel-Lusk Nasal Suction Forceps, Pediatric.....	81	Hexagonal Handle Osteotomes.....	91
Struempel Pediatric Forceps.....	77	Neivert Osteotome.....	91
Struempel-Voss Forceps .....	77	Osteotome, (Tardy Style) .....	93
Stryucken Turbinate Forceps.....	77	Parkes Lateral Osteotome .....	91
Takahashi Nasal Forceps .....	78	Rubin Osteotome.....	92
Takahashi Nasal Suction Forceps.....	82	Silver Osteotome.....	92
Thru-Flow Nasal Suction Forceps.....	82	Swiss Osteotomes .....	92
Walsham Septum Straightening Forceps.....	78		

Tardy Osteotome .....	93	Ruskin Rongeur .....	105
<b>NASAL OSTIUM SEEKERS</b>		<b>NASAL SAWS</b>	
Frontal Ostium Seeker .....	93	Joseph Nasal Saw .....	87
Maxillary Ostium Seeker.....	93	<b>NASAL SCISSORS</b>	
Ostium Probe .....	93	Becker Septum Scissors .....	106
<b>NASAL PICKS</b>		Caplan Nasal Bone Scissors, Double-Action .....	106
Mushroom Pick.....	94	Converse Dural Scissors.....	106
<b>NASAL PROBES</b>		Cottle Dorsal Scissors .....	106
Skilern Sinus Probe.....	94	Dorsal Scissors .....	107
<b>NASAL PUNCHES</b>		Fomon Dissecting Scissors.....	107
Antrum Punch, Sidebiting .....	97	Fomon Dorsal Scissors .....	107
Articulating Frontal Sinus Punch .....	95	Fomon Dorsal Scissor, W/Tungsten-Carbide Blades ..	107
Backbiter Forcep, Rotating .....	95	Fomon Lower Lateral Scissors.....	108
Circular Cutting Punch.....	95	Fomon Saber Back Scissors .....	108
Hajek-Koffler Antrum Punch .....	94	Goldman Septum Scissors.....	108
Hajek-Koffler Punch, Thru-Cut .....	96	Gorney Turbinate Scissors .....	108
Hajek-Kofler Sphenoid Punch, Rotating.....	96	Iris Scissors.....	109
McKenty Sphenoid Punch,Thru-Cut .....	96	Knapp Strabismus Scissors.....	109
Micro Backbiter Forceps .....	96	Knight Nasal Scissors .....	109
Ostrum Antrum Backbiter Punch .....	97	Lakeside Nasal Scissors .....	109
Punch Rongeur.....	97	Nasal Sinus Scissors, Adult.....	110
<b>NASAL RASPS</b>		Nasal Sinus Scissors, Pediatric.....	110
Converse Rasp.....	98	Ragnell Nasal Scissors.....	110
Fomon Rasp .....	98	Stevens Tenotomy Scissors .....	110, 111
Glabella Rasp, W/Tungsten-Carbide Teeth.....	98	<b>NASAL SNARES</b>	
Nasal Rasp, W/Tungsten-Carbide Teeth .....	99	Krause Nasal Snare .....	111
Wiener Antrum Rasp .....	99	Snare Wire .....	111
<b>NASAL RETRACTORS</b>		<b>NASAL SPECULA/SPECULUM</b>	
Army-Navy Retractor .....	100	Beckman Nasal Specula .....	112
Aufricht Nasal Retractor .....	100	Cottle Septum Speculum.....	112
Blair Retractor .....	100	Cottle Specula .....	112
Cheek Retractor .....	100	Halle Nasal Speculum .....	112
Converse Nasal Retractor .....	101	Hartmann Nasal Speculum.....	113
Cottle Alar Retractor.....	101	Killian Septum Specula .....	113
Cottle Knife Guide and Retractor.....	101	Palmer Nasal Speculum .....	335
Cottle Neivert Retractor.....	101	Palmer Piquet Specula .....	335
Cottle Retractor .....	101	Septum Speculum, Ebony .....	113
Cushing Vein Retractor .....	101	Sonnenschein Nasal Speculum.....	114
Fomon Retractor .....	102	Tieck Infant Nasal Speculum .....	114
Freer Hook/Retractor .....	102	Vacher Nasal Speculum .....	335
Goldman Knife Guide and Retractor .....	103	Vienna Nasal Specula, Conventional.....	114
Knapp Retractor .....	102	Vienna Nasal Specula, Modified .....	115
Love Nerve Root Retractor .....	102	Vienna Nasal Specula, Original.....	114
Neivert Knife Guide and Retractor .....	103	<b>NASAL SUCTION TUBES/ACCESSORIES</b>	
Ragnell Retractor .....	103	Ferguson-Frazier Suction Tube, Angled .....	115
Senn Retractor .....	103	Ferguson-Frazier Suction Tube, Strong Angle.....	115
University of Minnesota Cheek Retractor .....	100	Frazier Suction Tube, Medium Angle .....	116
<b>NASAL RONGEURS</b>		Kahn-Frazier Suction Tube .....	116
Beyer Rongeur .....	103	Laryngeal Suction Tube .....	116
Kerrison-Costen Rongeur .....	104	<b>NASAL TROCAR/CANNULAS</b>	
Kerrison Mastoid Rongeur.....	23, 104	Lichtwicz Antrum Trocar Needle .....	117
Lempert Rongeur, Heavy Pattern .....	24, 105	Ruskin Antrum Trocar Needle .....	117
Mini Friedman Rongeur .....	104	Sinus Trocar and Cannula .....	117
Rowland Bone Rongeur.....	105	Van Alyea Frontal Sinus Cannula.....	117
Ruskin Mini Rongeur .....	105		



**NEEDLE HOLDERS**

Barraquer Needle Holder ..... 184  
 Brown Needle Holder ..... 150  
 Castroviejo Needle Holder ..... 150  
 Crile-Wood Needle Holder ..... 149, 184  
  
 Crile-Wood Needle Holder, W/Tungsten-Carbide Jaws...  
 ..... 149  
 Derf Needle Holder ..... 151  
 Garabedian Needle Holder Insert Only ..... 243  
 Garabedian Needle Holder, W/Tungsten-Carbide Jaws...  
 ..... 242  
 Halsey Needle Holder, W/Tungsten-Carbide Jaws ..... 151  
 Halsey Needle Holder ..... 184  
 Mayo-Hegar Needle Holder,  
 W/Tungsten-Carbide Jaws..... 151  
 Mayo Hegar Needle Holder ..... 185  
 Olsen-Webster Needle Holder/Scissors,  
 W/Tungsten-Carbide Jaws..... 151  
 O'Brien Needle Holder ..... 185  
 Parell Needle Holder, W/Tungsten-Carbide Jaws..... 89  
 Perous Needle Holder Insert Only ..... 243  
 Ryder Needle Holder, W/Tungsten-Carbide Jaws ..... 152  
 Stratte Needle Holder ..... 185  
 W/Tungsten-Carbide Jaws ..... 150  
 Webster Needle Holder, W/Tungsten-Carbide Jaws .. 152  
 Webster Needle Holder ..... 152

**NEEDLES**

Hough Needle ..... 41  
 House Needle ..... 45  
 Jordan Needle ..... 48  
 KOS Needle..... 48  
 Lichtwicz Antrum Trocar Needle ..... 117  
 Needle, Sharp Point..... 20  
 Oro-Tracheal Laryngeal Injector Needles ..... 139  
 Schuknecht Needle ..... 53  
 Sinus Septum Needle, Angled Shaft ..... 90  
 Sinus Septum Needle, Bayonet Shaft..... 90  
 Tonsil Needle..... 130

**NEGUS**

Tonsil Seizing Forceps ..... 197

**NEIVERT**

Knife Guide and Retractor ..... 103  
 Osteotome..... 91

**NETTERVILLE**

Double-Ended Elevator..... 133  
 Instrument Tray ..... 133  
 Long Elevator ..... 133  
 Measuring Probe..... 133  
 Thyroplasty Instrument Set..... 132  
 Silicone Strip Holder ..... 132  
 Long Elevator ..... 132  
 Double-Ended Elevator ..... 132  
 Window Template ..... 132  
 Measuring Probe..... 132

Instrument Tray..... 132  
 Silicone Strip Holder ..... 132  
 Window Template..... 133

**NEWS**

Tracheal Retractor..... 127

**NIPPERS**

Dieter-Charachon Malleus Nipper ..... 272  
 Hough Crura Nipper Forceps, Very Fine..... 12  
 House-Dieters Malleus Nipper ..... 26

**NON-PERFORATING TOWEL CLAMPS ..... 166**

**NOYES**

Ear Dressing Forceps ..... 14  
 Nasal Dressing Forceps ..... 76

**O**

**O'BRIEN**

Needle Holder ..... 185

**OBWEGESER**

Channel Retractor..... 250  
 Flat Periosteal Elevator ..... 249  
 Mandibular Awl..... 250  
 Raspatory..... 369  
 Soft Tissue Retractor..... 250

**OBWEGESER-TESSIER**

Flat Periosteal Elevator ..... 249

**OFFRET**

Stitch Scissors..... 332

**OLSEN-WEBSTER**

Needle Holder/Scissors, W/Tungsten-Carbide Jaws.. 151

**OLYMPUS**

Fiberoptic Light Source Adapter..... 237, 378  
 Telescope Sleeve 2° W/Cleaning Port ..... 378  
 Telescope Sleeve 32° W/Cleaning Port ..... 378, 379  
 Telescope Sleeve 47° W/Cleaning Port ..... 379  
 Telescope Sleeve 72° W/Cleaning Port ..... 379

**OMBREDANNE**

Towel Forceps..... 181

**ORO-TRACHEAL**

Injector Cannula ..... 139  
 Laryngeal Injector Set..... 139

**ORSEL**

Maxillary Forceps..... 361  
 Suction Elevator..... 374  
 Suction Irrigation Cannula ..... 374

**O'SHAUGNESSY**

Tonsil Seizing Forceps ..... 197

**OSTEOTOMES**

Aiach Osteotome ..... 318  
 Anderson-Neivert Osteotome ..... 90  
 Becker Osteotome..... 318  
 Cinelli Osteotome..... 90  
 Claoue Osteotome ..... 318  
 Cottle Osteotome ..... 91  
 Hexagonal Handle Osteotomes..... 91

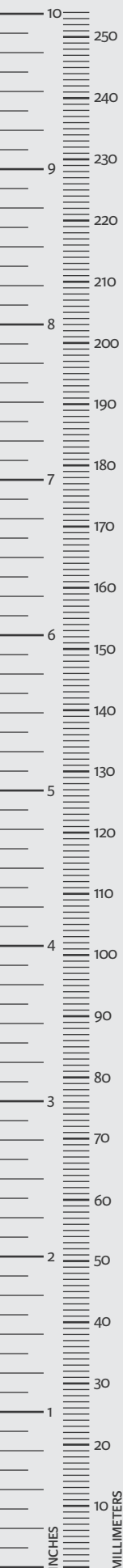

Kawamoto Osteotome .....	318	Minimally Invasive Sinus Instrument Set .....	341
Marchac Osteotome.....	319	Pedi Backbiting Forceps.....	341
McIndoe Osteotome .....	320	Push-Pull Anrostomy Blade .....	341
Neivert Osteotome.....	91	Sinus Probe.....	341
Osteotome, (Tardy Style) .....	93	Suction Elevator .....	341
Parkes Lateral Osteotome .....	91	Sinus Suction Tube.....	341
Pellegrini Osteotome .....	320	Suction Curette.....	341
Pollet Pech Osteotome .....	320	Instrument Tray.....	341
Robin Osteotome.....	320	<b>PEAN</b>	
Rubin Osteotome.....	92	Forceps.....	177
Silver Osteotome.....	92, 320	Pear-Shaped Cup Jaw Forceps.....	76
Swiss Osteotomes .....	92	<b>PECH-CANNONI</b>	
Tardy Osteotome .....	93	Rasp Single-Ended .....	323
Tessier Osteotome.....	249	<b>PELLEGRINI</b>	
<b>OSTIUM SEEKERS</b>		Dorsal Scissors.....	189
Frontal Ostium Seeker .....	93	Osteotome.....	320
Maxillary Ostium Seeker.....	93	Scissors .....	332
Ostium Probe .....	93	<b>PENNINGTON</b>	
<b>OSTRUM</b>		Elevator .....	70
Antrum Backbiter Punch.....	97	<b>PERFORATORS</b>	
<b>P</b>		Ear Perforator Burr.....	287
<b>PALMER</b>		Middle Ear Perforator .....	287
Nasal Speculum .....	335	<b>PERIOSTEAL</b>	
Piquet Specula .....	335	ENT Elevator.....	8
<b>PAPARELLA</b>		Joseph Periosteal Elevator .....	69/351
Duckbill Elevator.....	50	McKenty Periosteal Elevator .....	70
Fenestrometer.....	50	Obwegeser Flat Periosteal Elevator .....	249
Fine Needle.....	50	Obwegeser-Tessier Flat Periosteal Elevator .....	249
Heavy Needle .....	50	Pariteal Periosteal Elevator.....	144
Incudostapedial Joint Knife .....	50	Spreader.....	144
Sickle Knife.....	51	<b>PERIOSTEOTOME</b>	
“Whirlybird” Pick .....	51	Dean Periosteotome.....	8
<b>PAPARELLA-SAUNDERS</b>		<b>PERKINS</b>	
Hook.....	51	Retractor .....	22
Window Rasp and Marker.....	51	<b>PEROUSE</b>	
<b>PAPARELLA-WEITLANER</b>		Micro Elevator .....	227
Retractor .....	21	Needle Holder Insert Only.....	243
<b>PAPON</b>		<b>PESSEY</b>	
Endoscopic Tube Handle .....	210	Claw Retractor .....	327
Telescope Holder .....	210	<b>PEYNEGRE</b>	
<b>PARELL</b>		Nasal Scissors.....	332
Needle Holder, W/Tungsten-Carbide Jaws.....	89	Punch Forceps W/Cleaning Port .....	361
<b>PARKES</b>		Scissors .....	370
Hump Gouge .....	83	<b>PICKS</b>	
Lateral Osteotome.....	91	Austin Needle Pick.....	38
Rasp Single-Ended .....	323	Austin Pick.....	39
<b>PARSONS</b>		Blunt Pick.....	287
Accessories.....	341	Bruzzo Pick .....	287
Hockey Stick Seeker, Sharp.....	341	Charachon Pick .....	287
Uncinate Seeker, Angled .....	341	Curved Pick W/Suction .....	288
Maxillary Seeker, Curved.....	341	Ear Picks.....	288
Laryngeal Sprinkler .....	242	Guilford-Wright Footplate Hook .....	40
Maxillary Seeker .....	369	Guilford-Wright Stapes Pick.....	40
		Hough Pick .....	42

Hough Stapedectomy Pick.....	41
House-Crabtree Dissector Pick.....	43
House Oval Window Pick.....	46
House Pick.....	46
House Strut Pick.....	47
Legent Monopolar Pick.....	288
Marquet Pick.....	288
McGee Footplate Pick.....	49
Mushroom Pick.....	94
Portmann Handle Pick.....	288
Rosen Pick.....	52
<b>PIERCE</b>	
Elevator.....	70
<b>PIGNAT</b>	
Laryngoscope.....	236
<b>PITANGUY</b>	
Small Flap Demarcator.....	314
<b>PLASTIC SURGERY CHISELS</b>	
Cottle Chisel.....	311
Double Guarded Chisel.....	311
Jost Chisel.....	311
“V” Shaped Chisel.....	311
<b>PLASTIC SURGERY CURETTES</b>	
Volkman.....	311
<b>PLASTIC SURGERY ELEVATORS</b>	
Plastic Surgery Elevator.....	312
Sebileau Elevator.....	271, 313
Slamia Breast Elevator.....	313
Stenstrom Elevators.....	313
Trelat Elevators.....	313
<b>PLASTIC SURGERY ELEVATORS/DISSECTORS</b>	
Agris-Dingmann Elevator/Dissector.....	312
Elevator/Dissector.....	312
<b>PLASTIC SURGERY FORCEPS</b>	
Adson Dressing Forceps.....	146
Adson Tissue Forceps.....	147
Adson Tissue Forceps, Delicate.....	147
Adson Tissue Forceps, W/Tungsten-Carbide Jaws.....	146
Bipolar Jewelers Forceps.....	315
Bishop-Harmon Dressing Forceps.....	147
Bishop-Harmon Tissue Forceps.....	147
Brown-Adson Tissue Forceps.....	147
Castroviejo Suture Forceps.....	147
Cottle Columella Forceps.....	148
D'Assumpcao Flap Forceps.....	314
Dressing Forceps.....	148
Forceps W/Teeth.....	314
Graefe Fixation Forceps.....	148
Jeweler Forceps.....	148, 315
Jewelers Forceps.....	315
Micro Dissecting Forceps.....	314
Pitanguy Small Flap Demarcator.....	314
Potts-Smith Tissue Forceps.....	148
Servant Desepidermiser Pince Forceps.....	314
Tissue Forceps.....	148

**PLASTIC SURGERY GOUGES**

Killian Septum Gouge.....	315
“V” Shaped Gouge.....	315

**PLASTIC SURGERY HOOKS**

Ginestet Bone Hook.....	316
Humby Double Hook.....	316
Large Tendon Hook.....	316
Round Cartilage Hook.....	316

**PLASTIC SURGERY KNIVES**

Joseph Button End Knife.....	317
------------------------------	-----

**PLASTIC SURGERY MALLET**

Lombard Mallet.....	317
Mallet.....	317
Square Head Mallet.....	317

**PLASTIC SURGERY MISCELLANEOUS**

Areola Breast Markers.....	335
Bone Awl.....	336
Bone Graft Driver.....	336
Defourmental Breast Markers.....	336
Mole Breast Tensor.....	336

**PLASTIC SURGERY OSTEOTOMES**

Aiach Osteotome.....	318
Becker Osteotome.....	318
Claoue Osteotome.....	318
Kawamoto Osteotome.....	318
Marchac Osteotome.....	319
McIndoe Osteotome.....	320
Pellegrini Osteotome.....	320
Pollet Pech Osteotome.....	320
Robin Osteotome.....	320
Silver Osteotome.....	320

**PLASTIC SURGERY RASPATORIES**

Farabeuf Raspatory.....	324
Lempert Raspatory.....	312

**PLASTIC SURGERY RASPS**

Aufricht Rasps.....	321
Belloc Rasps.....	321
Bigot Rasps.....	321
Curved Rasp.....	322
Defourmental, Rasp.....	321
Diamond Dust Rasps, Single-Ended.....	322
Fomon Rasp, Double-Ended.....	322
Fomon Rasp, Single-Ended.....	322
Gorney Rasp, Double-Ended.....	322
Maltz Rasps, Single-Ended.....	322
Nasal Rasps, Single-Ended.....	323
Nasal Rasp, W/Tungsten-Carbide Teeth.....	323
Parkes Rasp, Single-Ended.....	323
Pech-Cannoni Rasp, Single-Ended.....	323
Rasp, Cross-Cut, Single-Ended.....	324
Rees Rasps, Double-Ended.....	324
Veau Rasps, Single-Ended.....	324

**PLASTIC SURGERY RETRACTORS**

Aufricht Nasal Retractor.....	325
Claoue Retractor.....	325





Converse Alar Retractor .....	325	Flap Knife .....	283
Desmarres Retractor.....	325	Retractor .....	291
Dufourmental Retractor .....	325	<b>POLITZER</b>	
Freeman Face Lift Retractor .....	326	Forceps.....	361
Freeman Flap Retractor .....	326	Lancet Knife Handle and Blades .....	283
Gorney Rake Retractor .....	326	<b>POLLET PECH</b>	
Joseph Retractor, (Skin Hook) .....	326	Osteotome.....	320
Jost Retractor .....	327	<b>PONCET</b>	
Kilner Retractor .....	327	Hooks .....	279
Loop and Ball End Retractor .....	327	<b>PORTMANN</b>	
Pessey Claw Retractor .....	327	Handle Pick.....	288
Ragnell Retractor .....	328	Hooks .....	279
Rake Retractor.....	328	Tongue Depressor.....	201
Right Angled Double Retractor .....	327	Tonsil Seizing Forceps .....	197
Senn-Miller Retractor .....	328	<b>POTTS-SMITH</b>	
Volkman Retractor.....	328	Tissue Forceps.....	148
<b>PLASTIC SURGERY RONGEURS</b>		<b>PRADES</b>	
Beyer Bone Rongeur .....	329	Alligator Forceps .....	362
<b>PLASTIC SURGERY SCISSORS</b>		Elevator .....	351
Becker Converse Scissors .....	329	<b>PRECELLI</b>	
Becker Wire Scissors, W/Tungsten-Carbide Blades ..	329	Dissecting Forceps.....	180
Boettcher Scissors .....	329	<b>PRESS</b>	
Bregat Scissors.....	329	Fascia Press .....	303
Brophy Gum and Suture Scissors.....	330	Footprint Press .....	303
Cartilage Scissors .....	187, 330	House Gelform Press .....	59
Converse Scissors .....	330	Sheehy Fascia Press .....	59
Cottle-Pech Scissors.....	330	<b>PROBES</b>	
Cottle Scissors.....	187, 330	Bowman Lacrimal-Probe, Stainless Steel .....	152
Dissecting Scissors.....	331	Jako Laryngeal Probes .....	135
Facelift Scissors, W/Guard .....	331	Lowinger Laryngeal Probe.....	239
Fomon Scissors .....	331	Marquet Ball Tip Probe.....	289
Gorney Plastic Surgery Scissors.....	153	Netterville Measuring Probe .....	133
Heymann-Klossek Scissors .....	331	Ostium Probe .....	93
Joseph Scissors .....	331	Sinus Probe.....	383
Kilner-Jost Scissors.....	332	Skillern Sinus Probe.....	94
Leger Scissors .....	332	Sterkers Ball Tip Probe .....	289
Micro Scissors, Spring Handled .....	332	Tenotome Probe.....	289
Offret Stitch Scissors .....	332	<b>PROETZ</b>	
Pellegrini Dorsal Scissors.....	332	Suction/Irrigator.....	205
Peynegre Nasal Scissors.....	332	<b>PROSTHESIS PLACEMENT HOOK (TABB)</b> .....	55
Plastic Surgery Scissors .....	159	<b>PUNCHES</b>	
Ragnell Undermining Scissors .....	333	Antrum Punch, Sidebiting .....	97
Reynolds Scissors .....	333	Articulating Frontal Sinus Punch .....	95
Rouvier Scissors.....	333	Backbiter Forcep, Rotating .....	95
Scissors, Spring Handle .....	159	Circular Cutting Punch.....	95
Shea Vein Graft Scissors.....	333	Hajek-Koffler Antrum Punch .....	94
Stevens Tenotomy Scissors .....	334	Hajek-Koffler Punch, Thru-Cut .....	96
Straight Scissors .....	333	Hajek-Kofler Sphenoid Punch, Rotating.....	96
Vannas Scissors.....	334	King Adenoid Punch .....	126
Weit Scissors .....	334	McKenty Sphenoid Punch,Thru-Cut .....	96
<b>PLASTIC SURGERY SPECULA/SPECULUM</b>		Meltzer Adenoid Punch .....	126
Palmer Nasal Speculum .....	335	Micro Backbiter Forceps .....	96
Palmer Piquet Specula .....	335	Ostrum Antrum Backbiter Punch .....	97
Vacher Nasal Speculum .....	335	Punch Biopsy Forceps, Thru-Cut .....	76
<b>PLESTER</b>		Punch Rongeur.....	97
Elevator .....	271		

Ronis Adenoid Punch ..... 126

**R**

**RAGNELL**

Nasal Scissors..... 110  
 Retractor ..... 103, 328  
 Undermining Scissors ..... 189, 333

**RAKE RETRACTOR** ..... 328

**RASPATORIES**

Ear Raspatory ..... 268  
 Farabeuf Raspatory..... 324  
 Lempert Raspatory ..... 312

**RASPS**

Aufricht Rasps ..... 321  
 Belloc Rasps..... 321  
 Bigot Rasps..... 321  
 Converse Rasp..... 98  
 Curved Rasp..... 322  
 Defourmentel, Rasp..... 321  
 Diamond Dust Rasps, Single-Ended ..... 322  
 Fomon Rasp, Double-Ended..... 322  
 Fomon Rasp, Single-Ended ..... 322  
 Fomon Rasp ..... 98  
 Glabella Rasp, W/Tungsten-Carbide Teeth..... 98  
 Gorney Rasp, Double-Ended..... 322  
 Joseph Rasp ..... 369  
 Maltz Rasps, Single-Ended..... 322  
 Marquet Rasp ..... 289  
 McCabe Perforation Rasp ..... 49  
 McGee Oval Window Rasp ..... 49  
 Nasal Rasp, W/Tungsten-Carbide Teeth ..... 99, 323  
 Nasal Rasps, Single-Ended ..... 323  
 Obwegeser Raspatory ..... 369  
 Parkes Rasp, Single-Ended ..... 323  
 Pech-Cannoni Rasp, Single-Ended..... 323  
 Rasp, Cross-Cut, Single-Ended..... 324  
 Rees Rasps, Double-Ended..... 324  
 Stenstrom Rasp..... 289  
 Veau Rasps, Single-Ended ..... 324  
 Wiener Antrum Rasp ..... 99

**REAL TISSUE FORCEPS**.....180

**REDON**

Dissecting Forceps..... 197

**REES**

Rasps Double-Ended..... 324

**RETRACTORS**

Angot-Vanecloo Retractor ..... 290  
 Army-Navy Retractor ..... 100  
 Aufricht Nasal Retractor ..... 100, 325  
 Beckman-Weitlaner Retractor ..... 290  
 Bellucci-Wulstein Retractor ..... 21  
 Bizeau Retractor..... 290  
 Blade Retractor ..... 202  
 Blair Retractor ..... 100

Cheek Retractor ..... 100  
 Claoue Retractor..... 325  
 Converse Alar Retractor ..... 325  
 Converse Nasal Retractor ..... 101  
 Cottle Alar Retractor..... 101  
 Cottle Knife Guide and Retractor ..... 101  
 Cottle Neivert Retractor..... 101  
 Cottle Retractor ..... 101  
 Cushing Vein Retractor ..... 101  
 Dautrey Retractor ..... 369  
 Desmarres Retractor..... 186, 325  
 Dufourmentel Retractor ..... 325  
 Farabeuf Retractors ..... 186  
 Flexible Arm Retractor ..... 304  
 Fomon Retractor ..... 102  
 Freeman Face Lift Retractor ..... 326  
 Freeman Flap Retractor ..... 326  
 Freer Hook/Retractor ..... 102  
 Goldman Knife Guide and Retractor ..... 103  
 Goodyear Uvula Retractor ..... 127  
 Gorney Rake Retractor ..... 326  
 Heiss Automatic Skin Retractor ..... 21  
 Hurd Dissector/Pillar Retractor..... 123  
 Hurd Elevator/Pillar Retractor, Coated..... 195  
 Hurd Elevator/Pillar Retractor ..... 195  
 J. House Vascular Strip Retractor ..... 21  
 Joseph Retractor, (Skin Hook) ..... 326  
 Jost Retractor ..... 327  
 Kilner Retractor ..... 327  
 Knapp Retractor ..... 102  
 Laryngeal Retractor ..... 239  
 Leroux Robert Retractor ..... 202  
 Loop and Ball End Retractor ..... 327  
 Love Nerve Root Retractor ..... 102  
 Love Uvula Retractor ..... 127  
 Mondain Retractor ..... 290  
 Morrison-Hurd Dissector and Pillar Retractor ..... 123  
 Neivert Knife Guide and Retractor ..... 103  
 News Tracheal Retractor ..... 127  
 Obwegeser Channel Retractor..... 250  
 Obwegeser Soft Tissue Retractor ..... 250  
 Paparella-Weitlaner Retractor..... 21  
 Perkins Retractor ..... 22  
 Pessey Claw Retractor ..... 327  
 Plester Retractor ..... 291  
 Ragnell Retractor ..... 103, 328  
 Rake Retractor ..... 328  
 Retractor ..... 239  
 Ribbon Retractors-Malleable ..... 186  
 Right Angled Double Retractor ..... 327  
 Robier Retractor..... 290  
 Schuknecht Retractor ..... 291  
 Schuknecht-Weitlaner Retractor..... 22  
 Senn-Miller Retractor ..... 186, 328  
 Senn Retractor ..... 103  
 University of Minnesota Cheek Retractor ..... 100



Volkman Retractor.....	328	Sinus Trocar and Sleeve .....	383
Weitlaner-Wullstein Retractor .....	291	Speculum .....	372
Weitlaner Retractor (Baby) .....	291	Suction Tube-Elevator .....	351
Weitlaner Retractor .....	22, 291	<b>ROWLAND</b>	
Wullstein-Weitlaner Retractor .....	22	Bone Rongeur.....	105
<b>RETRACTORS/ELEVATORS</b>		<b>ROYCE</b>	
Hurd Elevator/Pillar Retractor .....	195	Ear Knife Angled .....	19
Hurd Elevator/Pillar Retractor, Coated.....	195	Ear Knife Bayonet.....	19
<b>REYNOLDS</b>		<b>RUVAULT</b>	
Scissors .....	333	Sickle Knife .....	205
<b>REYT</b>		<b>RUBIN</b>	
Diverticuloscope.....	225	Osteotome.....	92
<b>RIGHT ANGLED DOUBLE RETRACTOR</b> .....	327	Septum Morselizer .....	89
<b>RIBBON RETRACTOR, MALLEABLE</b> .....	186	Septum Morselizer Guard.....	89
<b>ROBIER</b>		<b>RULERS</b>	
Measuring Rods (Calipers).....	285	Ruler .....	144
Retractor .....	290	<b>RUSKIN</b>	
<b>ROBIN</b>		Antrum Trocar Needle .....	117
Osteotome.....	320	Bone Cutting Forceps .....	363
<b>ROCHESTER-OCCHNER</b>		Mini Rongeur.....	105
Artery Forceps .....	165	Rongeur .....	24, 105
<b>ROCHESTER-PEAN</b>		<b>RYDER</b>	
Artery Forceps .....	166	Needle Holder, W/Tungsten-Carbide Jaws .....	152
<b>ROEDER</b>		<b>S</b>	
Towel Forceps.....	166	<b>SABER BACK SCISSORS</b> .....	189
<b>ROMANET</b>		<b>SAGE</b>	
Curette .....	266	Tonsil Snare Straight Tip.....	128
<b>RONGEURS</b>		<b>SAINT PAUL</b>	
Beyer Bone Rongeur, Double-Action .....	329	Ear Loop .....	284
Beyer Bone Rongeur, Single-Action .....	23, 103	<b>SATALOFF</b>	
Kerrison-Costen Rongeur .....	104	Indirect Laryngeal Instrument Set.....	224
Kerrison Mastoid Rongeur.....	23, 104	Flap Knife.....	224
Lempert Rongeur, Heavy Pattern .....	24, 105	Indirect Alligator Forceps .....	224
Mini Friedman Rongeur .....	23, 104	Indirect Cup Forceps .....	224
Punch Rongeur.....	97	Indirect Heart Shaped Forceps.....	224
Rowland Bone Rongeur.....	105	Indirect Scissors .....	224
Ruskin Mini Rongeur .....	105	Indirect Suction Tube.....	224
Ruskin Rongeur .....	24, 105	Instrument Tray.....	224
<b>RONIS</b>		Laryngeal Dilator .....	224
Adenoid Punch.....	126	Modular Handle.....	224
<b>ROSEN</b>		Oro-Tracheal Injector .....	224
Cartilage Knife .....	149	Sharp Knife .....	224
Elevator .....	271	Sickle Knife.....	224
Pick .....	52	Vascular Knife.....	224
Sickle Knife .....	284	Laryngoscopes.....	222
Suction Tube .....	36	Anterior Commissure Laryngoscope .....	222
<b>ROUVIER</b>		Dual Suction with Light Fibers, Large.....	222
Alligator Forceps .....	362	Dual Suction with Light Fibers, Medium.....	222
Cup Forceps .....	362	Dual Suction with Light Fibers, Small-Medium...	222
Cup Forceps W/Cleaning Port .....	362	Dual Suction with Light Fibers, Small.....	222
Monopolar Knife.....	368	Vallecula Laryngoscope .....	222
Monopolar Knife W/Suction .....	368	Laryngoscope Accessories .....	223
Punch Forceps .....	362	Microlaryngeal Instrument Set.....	219
Scissors .....	333, 370		

Adapter, Angled .....	220	Boettcher Scissors .....	329
Alligator Forceps .....	220	Bregat Scissors .....	329
Alligator Forceps, Fine .....	220	Brophy Gum and Suture Scissors .....	152, 330
Ball Dissectors .....	219	Caplan Nasal Bone Scissors, Double-Action .....	106
Collagen Injection Needle .....	219	Cartilage Scissors .....	187
Connector for Injection Needle .....	219, 220	Cartilage Scissors .....	330
Cotton Applicator .....	219	Converse Double-Edge Scissors .....	153
Cup Forceps, Downbite .....	219	Converse Dural Scissors .....	106
Curette .....	220	Converse Scissors .....	187, 330
Flap Knife .....	220	Cottle-Pech Scissors .....	330
French Velvet Eye Suction .....	219	Cottle Dorsal Scissors .....	106
Grasper, Heart Shaped .....	220	Cottle Scissors .....	187, 330
Hook .....	219	Dean Tonsil Scissors .....	128
Knife Handle .....	220	Dessi Scissors, W/Cleaning Port .....	370
Mirror .....	219	Dissecting Scissors .....	331
Percutaneous Injection Needle .....	220	Dorsal Scissors .....	107
Sharp Knife .....	220	Facelift Scissors, W/Guard .....	331
Sickle Knife .....	220	Fauer Sinus Scissors .....	370
Spatula .....	219	Fisch Crura Scissors .....	25
Universal Ring Handle .....	219	Fomon Dissecting Scissors .....	107
Vascular Knife .....	220	Fomon Dorsal Scissor, W/Tungsten-Carbide Blades ..	107
Microlaryngeal Instrument Accessories .....	221	Fomon Dorsal Scissors .....	107, 153
Thyroplasty Elevator .....	138	Fomon Lower Lateral Scissors .....	108
<b>SAUVAGE</b>		Fomon Saber Back Scissors .....	108
Measuring Rod (Caliper) .....	286	Fomon Scissors .....	331
<b>SAWS</b>		Forehead Scissors .....	154
Joseph Nasal Saw .....	87	Fox Scissors .....	187
<b>SCHNIDT</b>		Freeman Rhytidectomy Scissors .....	154
Tonsil Forceps .....	122	Goldman Septum Scissors .....	108
Tonsil Seizing Forceps .....	197	Gorney Plastic Surgery Scissors .....	154
<b>SCHNIDT-BOETTCHER</b>		Gorney Turbinate Scissors .....	108
Tonsil Forceps .....	122	Guerrier Tonsil Scissors .....	202
<b>SCHUKNECHT</b>		Guilford-Wright Wire Cutting Scissors .....	160
Footplate Hook .....	52	Heymann-Klossek Scissors .....	188, 331
Hook .....	53	House-Bellucci Alligator Scissors, Delicate .....	26
Needle .....	53	Iris Scissors, Large Finger Rings, Sharp/Sharp .....	155
Retractor .....	291	Iris Scissors, Sharp/Blunt .....	155
Roller Knife .....	52	Iris Scissors, Sharp/Sharp .....	154, 155
Sickle Knife .....	53	Iris Scissors, Sure-Grip, W/Tungsten-Carbide Blades ..	156
Spatula .....	53	Iris Scissors, "Supercut" .....	156
Suction Tube .....	36	Iris Scissors .....	109
Whirlybird Excavator .....	53	Jako Microlaryngeal Scissors .....	135
Wire Bending Die .....	305	Jankowski Sinus Scissors, W/Cleaning Port .....	370
Wire Crimping Forceps .....	15	Joseph Scissors, Double Edge .....	156
<b>SCHUKNECHT-WEITLANER</b>		Joseph Scissors .....	156, 188, 331
Retractor .....	22	Kaye Dissecting Scissors, Fine .....	157
<b>SCISSORS</b>		Kaye Facelift Scissors, W/Tungsten-Carbide Blades ..	157
Baby Metzenbaum Scissors .....	153	Kaye Facelift Scissors .....	157
Becker Converse Scissors .....	329	Kilner-Jost Scissors .....	332
Becker Septum Scissors .....	106	Kleinsasser Microlaryngeal Scissors .....	137
Becker Wire Scissors, W/Tungsten-Carbide Blades .....	161, 187, 329	Knapp Strabismus Scissors .....	109, 157
Bellucci Scissors, Micro, Black Finish .....	25	Knight Nasal Scissors .....	109
Bellucci Scissors, Miniature, Fine .....	25	Lahey Dissecting Scissors .....	158
Bellucci Scissors, Very Fine .....	25	Lakeside Nasal Scissors .....	109
		Leger Scissors .....	332
		Lister Bandage Scissors .....	158

Littler Suture Carrying Scissors .....	158
Matzenbaum Scissors, Delicate .....	188
Mayo Scissors, Beveled Blades .....	157, 188
Mayo Scissors, W/Tungsten-Carbide Blades .....	158
Metzenbaum Scissors, Delicate .....	159
Metzenbaum Scissors, W/Tungsten-Carbide Blades .....	159
Metzenbaum Scissors-Standard .....	189
Metzenbaum Scissors .....	128
Micro Scissors, Spring Handled .....	332
Micro Scissors .....	239, 293
Nasal Sinus Scissors, Adult .....	110
Nasal Sinus Scissors, Pediatric .....	110
Offret Stitch Scissors .....	332
Operating Scissors .....	160, 189
Pellegrini Dorsal Scissors .....	189, 332
Peynegre Nasal Scissors .....	332
Peynegre Scissors .....	370
Plastic Surgery Scissors .....	160
Ragnell Nasal Scissors .....	110
Ragnell Undermining Scissors .....	189, 333
Reynolds Scissors .....	333
Rouvier Scissors .....	333, 370
Scissors, Saber Back .....	189
Scissors, Spring Handle .....	160
Shea Vein Graft Scissors .....	190, 333
Sterkers-Micro Scissors .....	293
Stevens Stitch Scissors, Ribbon Type .....	161
Stevens Stitch Scissors .....	161
Stevens Tenotomy Scissors .....	110, 111, 161, 190, 334
Straight Scissors .....	333
Streiff Scissors .....	190
Tessier Dissecting Scissors .....	250
Universal Wire Suture Scissors .....	161
Vannas Scissors .....	334
Weit Scissors .....	334
Woo Laryngeal Scissors .....	239
<b>SEAMANN SEIFFERT</b>	
Mouth Gag .....	200
<b>SEBILEAU</b>	
Elevator .....	271, 313
<b>SELESNICK</b>	
Lateral Skull Base Set .....	261
Hooks .....	261, 262
Dissectors .....	261
Elevators .....	261
Spatula-Dissectors .....	261
Micro Curettes .....	261
Cup Forceps .....	261
Whirlybird Picks .....	261
Sickle Knife .....	261
Dissecting Scissors .....	262
Neurotology Coagulating Bipolar Forceps .....	262
Angot-Venecloo Retractor .....	262
Bifurcated Bipolar Cable .....	262
Instrument Tray, Two Level .....	262
Pick Tray .....	262
<b>SENN</b>	
Retractor .....	103
<b>SENN-MILLER</b>	
Retractors .....	186, 328
<b>SEPARATORS</b>	
Ear Separator .....	272
House Separator .....	46
Separator .....	272
<b>SERVANT</b>	
Desepidermiser Pince Forceps .....	314
<b>SHAPLEIGH</b>	
Ear Curette .....	7
<b>SHEA</b>	
Curette .....	54
Fenestration Hook .....	54
Footplate Hook .....	54
Incision Knife .....	54
Oblique Hook .....	54
Speculum Holder .....	31
Vein Graft Scissors .....	190, 333
<b>SHEEHY</b>	
Fascia Press .....	59
Ossicle Holding Clamp .....	16
<b>SICKLE KNIFE</b> .....	87
<b>SILICONE MAT</b> .....	192
<b>SILVER</b>	
Osteotome .....	92, 320
<b>SINUS CURETTES</b>	
Freche Sinus Curette .....	349
Jankowski Sinus Curette .....	349
Klossek Curette .....	349
Klossek Curette/Elevator .....	349
LDG Sinus Curette .....	349
<b>SINUS ELEVATORS</b>	
Cottle-Mckenty Elevator .....	350
Cottle Septum Elevator .....	350
Dissector/Elevator .....	350
Guillen Suction Tube-Elevator .....	350
Herman Elevator .....	350
Howarth Elevator .....	350
Joseph Periosteal Elevator .....	69, 351
Prades Elevator .....	351
Rouvier Suction Tube-Elevator .....	351
Suction Tube-Elevator .....	351
<b>SINUS FORCEPS</b>	
Backbiting Forceps .....	352
Backbiting Forceps, Rotatable .....	352
Blakesley Forceps .....	352
Blakesley Forceps-Fenestrated .....	353
Bossard Cup Forceps-Fenestrated .....	353
Citelli-Freche Forceps .....	353
Citelli Punch Forceps .....	353
Clip-Applying Forceps .....	354



De Gabory Laryngeal Cup Forceps, W/Cleaning Port	358	Monopolar Suction Tube	368
Dessi Bipolar Forceps	354	Rouvier Monopolar Knife	368
Dessi Bipolar Forceps, Detach	354	Rouvier Monopolar Knife, W/Suction	3,663
Dessi Universal Cup Forceps	355	<b>SINUS NEEDLES</b>	
Faure Fenestrated Forceps	355	Sinus Septum Needle, Angled Shaft	90
Fenestrated Cup Forceps	355	Sinus Septum Needle, Bayonet Shaft	90
Fenestrated Cup Forceps W/Cleaning Port	356	<b>SINUS OSTIUM SEEKERS</b>	
Frontal Recess Forceps	355	Frontal Ostium Seeker	93, 369
Jankowski Cup Forceps	356, 357	Maxillary Ostium Seeker	93
Jankowski Cup Forceps, Fenestrated	357	Parsons Maxillary Seeker	369
Jankowski Cup Forceps W/Cleaning Port	356	<b>SINUS RASPS</b>	
Jankowski Heartshaped Cup Forceps	357	Joseph Rasp	369
Jansen-Middleton Forceps	357	Obwegeser Raspatory	369
Josephine Terrier Punch Forceps	357	<b>SINUS RETRACTORS</b>	
Klossek Cup Forceps, Fenestrated	358	Dautrey Retractor	369
Klossek Cup Forceps, W/Suction	358	<b>SINUS SCISSORS</b>	
Large Fenestrated Cup Forceps	358	Dessi Scissors, W/Cleaning Port	370
Lubet Barbon Forceps	359	Fauer Sinus Scissors	370
Lucae Ear Forceps	359	Jankowski Sinus Scissors, W/Cleaning Port	370
Luc Nasal Cup Forceps	359	Peynegre Scissors	370
Luc Nasal Spoon Forceps	359	Rouvier Scissors	370
Lusk MicroBite™ Forceps	360	<b>SINUS SPECULA/SPECULUM</b>	
Mini-Struycken Through-Cutting Forceps	360	Beckman Speculum	371
Orsel Maxillary Forceps	361	Cottle Speculum	371
Oval Cup Forceps	361	Hartmann Speculum	371
Peynegre Punch Forceps, W/Cleaning Port	361	Killian Nasal Speculum	371
Politzer Forceps	361	Killian Nasal Speculum, W/Fiberoptics	371
Prades Alligator Forceps	362	Nasal Speculum	372
Rouvier Alligator Forceps	362	Rouvier Speculum	372
Rouvier Cup Forceps	362	Tieck-Halle Speculum	372
Rouvier Cup Forceps W/Cleaning Port	362	Vacher Nasal Speculum	372
Rouvier Punch Forceps	362	Vienna Nasal Speculum	372
Ruskin Bone Cutting Forceps	363	<b>SINUS SUCTION TUBES/ACCESSORIES</b>	
Small Fenestrated Cup Forceps	363	Claoue Suction Tube and Probe	373
Stamm Cup Forceps, W/ Cleaning Port	363	De Gabory Suction Tube Handle	376
Straight Cup Forceps, W/ Cleaning Port	363	Faure Suction Tube	373
Weil-Blakesley Forceps	363	Frazier Suction Irrigation System	373
Wormald Anterior Skull Base Clip-Appling Forceps	364	Guillen Suction Tube-Elevator	373
Wormald Bipolar Forceps with Suction	365	Jankowski Suction Tube	373
<b>SINUS KNIVES</b>		Jankowski Suction Tube, W/Bulbus Tip	374
Ballenger Swivel Knife	366	Orsel Suction Elevator	374
Fredrich Sickle Knife	366	Orsel Suction Irrigation Cannula	374
<b>SINUS MISCELLANEOUS</b>		Suction Cannula	374
Cleaning Adapter	383	Suction Irrigation Cannula	374
Dessi Suction Irrigation Pump	383	Suction Irrigation Tube	376
Legent Flexible Tension Arm	384	Suction Tube	375
Legent Flexible Tension Arm Accessories	384	Suction Tube, Angled	375
Rouvier Sinus Trocar and Sleeve	383	Suction Tube, Blunt, Malleable	375
Sinus Probe	383	Suction Tube Elevator	375
Sinus Trocar and Cannula	117	Suction Tube-Elevator, Rotatable	374
<b>SINUS MONOPOLAR INSTRUMENTS</b>		Suction Tube, W/Bulbus Tip	376
Apfelbaum Monopolar Suction Tube	367	<b>SINUS TELESCOPE SLEEVES/ACCESSORIES</b>	
Freche Monopolar Knife	367	Comeg Telescope Sleeve, 2°, W/Cleaning Port	377
Freche Monopolar Suction Tube	367	Comeg Telescope Sleeve, 32°, W/Cleaning Port	377
Herman Monopolar Hook	367	Comeg Telescope Sleeve, 47°, W/Cleaning Port	377

Comeg Telescope Sleeve, 72°, W/Cleaning Port .....	377	Cottle Septum Speculum .....	112
Olympus Fiberoptic Light Source Adapter .....	378	Cottle Specula .....	112
Olympus Telescope Sleeve, 2°, W/Cleaning Port.....	378	Cottle Speculum .....	371
Olympus Telescope Sleeve, 32°, W/Cleaning Port .....	378, 379	Darrouzet Speculum.....	294
Olympus Telescope Sleeve, 47°, W/Cleaning Port.....	379	Deveze Speculum .....	294
Olympus Telescope Sleeve, 72°, W/Cleaning Port.....	379	Diagnostic Ear Speculum, Disposable .....	295
Storz Fiberoptic Adapter.....	380	Ear Speculum, Oval Oblique, Black Finish.....	30
Storz Telescope Adapter .....	380	Farrior Speculum, Oval.....	28
Storz Telescope Sleeve, 2°, W/Cleaning Port .....	380	Farrior Speculum, Oval Oblique.....	28
Storz Telescope Sleeve, 32°, W/Cleaning Port .....	380	Farrior Speculum, Round .....	27
Storz Telescope Sleeve, 47°, W/Cleaning Port .....	380	Gruber Speculum, Oval.....	29
Storz Telescope Sleeve, 72°, W/Cleaning Port .....	381	Gruber Speculum, Round .....	28
Telescope Sleeve, W/Cleaning Port .....	382	Halle Nasal Speculum .....	112
Telescope Support Forceps.....	382	Hartmann Nasal Speculum.....	113
Wolf Fiberoptic Light Source Adapter.....	381	Hartmann Speculum .....	371
Wolf Telescope Adapter .....	381	Hartmann Speculum, Oval .....	29
Wolf Telescope Sleeve, 2°, W/Cleaning Port .....	381	Hartmann Speculum, Round .....	29
Wolf Telescope Sleeve, 32°, W/Cleaning Port .....	381	Killian Nasal Speculum, W/Fiberoptics .....	371
Wolf Telescope Sleeve, 47°, W/Cleaning Port .....	382	Killian Nasal Speculum.....	371
Wolf Telescope Sleeve, 72°, W/Cleaning Port .....	382	Killian Septum Specula .....	113
<b>SINUS TROCAR AND CANNULAS .....</b>	<b>117</b>	Legent Diagnostic Ear Speculum.....	294
<b>SISSON</b>		Legent Otoscope .....	294
Nerve Hook .....	85	Le Mee Diagnostic Ear Speculum .....	295
<b>SKILLERN</b>		Nasal Speculum .....	372
Sinus Probe.....	94	Palmer Nasal Speculum .....	335
<b>SKINNER</b>		Palmer Piquet Specula .....	335
Maxillary Biopsy Forceps .....	77	Rouvier Speculum.....	372
<b>SLAMIA</b>		Septum Speculum, Ebony .....	113
Breast Elevator .....	313	Sonnenschein Nasal Speculum.....	114
<b>SLUDER</b>		Tieck-Halle Speculum.....	372
Tonsillectome.....	204	Tieck Infant Nasal Speculum .....	114
<b>SNARES</b>		Toynbee Speculum, Round.....	30
Bruenings Tonsil Snare.....	202	Vacher Nasal Speculum .....	335, 372
Eve Tonsil Snare .....	128	Vienna Nasal Specula, Conventional.....	114
Krause Nasal Snare .....	111	Vienna Nasal Specula, Modified .....	115
Sage Tonsil Snare, Straight Tip .....	128	Vienna Nasal Specula, Original .....	114
Tyding Tonsil Snare.....	129	Vienna Nasal Speculum .....	372
Vacher Tonsil Snare .....	203	<b>SPECULUM HOLDER</b>	
<b>SNARE WIRE</b>		Shea Speculum Holder.....	31
Krause Snare Wire, Pre-Shaped .....	203	Universal Speculum Holder.....	30
Lermoyer Snare Wire, Pre-Shaped.....	203	<b>SPLINTS</b>	
Snare Wire, Pre-Cut.....	129	Camo Dental Splint-Disposable .....	204
Snare Wire .....	111	Davis Boyle Dental Splint.....	198
<b>SNELLEN</b>		<b>SPONGE FORCEPS</b>	
Ear Loop .....	284	Foerster Sponge Forceps .....	166
<b>SONNENSCHNEIN</b>		<b>SPRAGUE</b>	
Nasal Speculum .....	114	Ear Curette .....	7
<b>SPATULAS</b>		<b>SPRING HANDLE SCISSORS.....</b>	<b>159</b>
Schuknecht Spatula .....	53	<b>STAINLESS STEEL</b>	
<b>SPECULA/SPECULUM</b>		Stainless Steel Cups .....	191
Beckman Nasal Specula .....	112	Stainless Steel Plate.....	192
Beckman Speculum .....	371	Stainless Steel Trays .....	192
Boucheron Speculum, Round.....	27	<b>STAMM</b>	
		Cup Forceps W/ Cleaning Port .....	363
		Skull Base Instrument Set.....	342

Cup Forceps, Bayonet.....	342	Andrews Suction Tube .....	129
Hook.....	342	Barnes Suction Tube.....	32
Ball Seeker .....	342	Baron Suction Tube .....	32
Scissors, Bayonet.....	342	Bellucci Suction Tube .....	33
Elevators .....	342	Brackman Suction Irrigator .....	296
Malleable Suctions.....	342	Brackman Suction Tube .....	33
Suction Tubes, Angled .....	342	Brasnu Suction Tube.....	240
Bipolar Forceps .....	342	Causse Suction Irrigator .....	296
Instrument Tray.....	342	Charachon Suction Tube W/Thumb Control.....	300
Bifurcated Bipolar Cable .....	342	Claoue Suction Tube and Probe.....	373
<b>ST. CLAIRE THOMPSON</b>		De Gabory Suction Tube Handle.....	376
Adenoid Forceps .....	122	Dubreui Suction Tube.....	296
<b>ST. PAUL</b>		Faure Suction Tube .....	373
St. Paul Ear Loop .....	284	Ferguson-Frazier Suction Tube, Angled .....	33, 115
<b>STENSTROM</b>		Ferguson-Frazier Suction Tube, Strong Angle.....	33, 115
Elevators .....	313	Forehead Suction Elevator.....	144
Rasp .....	289	Frayse Suction Tube W/Luer Lock .....	296
<b>STERKERS</b>		Frazier Suction Irrigation System .....	373
Alligator Micro-Forceps .....	276	Frazier Suction Tube, Medium Angle .....	116
Ball Tip Probe .....	289	Frazier Suction Tube .....	34
Curette .....	267	Garabedian Suction Tube.....	240
Hooks .....	279	Guilford-Wright Suction Tube.....	34
Micro Scissors .....	293	Guillen Suction Tube-Elevator .....	373
Sickle Knife .....	284	House-Baron Suction Tube .....	35
Suction Irrigator .....	298	House Cutoff Suction Adapter .....	34
<b>STEVENS</b>		House Suction Adapter.....	297
Stitch Scissors.....	161	House Suction Irrigator .....	35
Stitch Scissors Ribbon Type .....	161	House Suction Tube .....	300
Tenotomy Scissors.....	110, 111, 161, 190, 334	Huttenbrink Suction Tube .....	241
<b>STORZ</b>		Jankowski Suction Tube, W/Bulbus Tip .....	374
Fiberoptic Light Source Adapter.....	237, 380	Jankowski Suction Tube.....	373
Telescope Adapter .....	380	Kahn-Frazier Suction Tube .....	35, 116
Telescope Sleeve 2° W/Cleaning Port .....	380	Laryngeal .....	134
Telescope Sleeve 32° W/Cleaning Port .....	380	Laryngeal Suction Tube .....	116
Telescope Sleeve 47° W/Cleaning Port .....	380	Lempert Suction Tube.....	297
Telescope Sleeve 72° W/Cleaning Port .....	381	Luer-Lock Adapter.....	301
Wolf Telescope Adapter.....	380	Maspétiol Suction Tube .....	297, 298
<b>STRATTE</b>		McGee Suction Tube .....	35
Needle Holder .....	185	MicroLite Suction Needles (Disposable) .....	32
<b>STREIFF</b>		Microsurgery Suction Tube .....	297
Scissors .....	190	Monopolar Suction Tube .....	240
<b>STRUEMPEL</b>		Orsel Suction Elevator .....	374
Ear Forceps Fine .....	15	Orsel Suction Irrigation Cannula .....	374
Pediatric Forceps.....	77	Proetz Suction/Irrigator.....	205
<b>STRUEMPEL-LUSK</b>		Rosen Suction Tube .....	36
Nasal Suction Forceps, Pediatric.....	81	Rosen-Type Suction Cannula .....	298
<b>STRUEMPEL-VOSS</b>		Rouvier Suction Tube Elevator .....	351
Forceps .....	77	Schuknecht Suction Tube.....	36
<b>STRYUCKEN</b>		Sterker Suction Irrigator.....	298
Turbinate Forceps .....	77	Suction Cannula .....	299, 374
<b>STUBBS</b>		Suction Handle W/Bypass Control (Disposable).....	32
Adenoid Currettes .....	121	Suction Irrigation Cannula .....	374
<b>SUCTION TUBES/ACCESSORIES</b>		Suction Irrigation Tube .....	299
Andrews-Pynchon Suction Tube .....	129	Suction Irrigator .....	299
		Suction Tube, Angled .....	375
		Suction Tube, Blunt, Malleable .....	375



Suction Tube, W/Bulbus Tip.....	376
Suction Tube-Elevator, Rotatable.....	374
Suction Tube.....	375
Suction Tube Cannula.....	240, 241
Suction Tube Elevator.....	375
Suction Tube Handle.....	300
Suction Tube with Finger Control.....	300
Thomassin Suction Tube.....	298
Turning Adapter Luer Lock.....	301
Wertheimer Suction Tube.....	297
Yankauer Suction Tube.....	129
Zimmermann Suction Tube W/Luer Lock.....	301
<b>SULCUS</b>	
Elevator.....	271
<b>SUTURE AND FIXATION FORCEPS</b>	
Castroviejo Forceps.....	182
<b>SWANN-MORTON</b>	
Scalpel Handle.....	292
<b>T</b>	
<b>T-TUBE</b>	
Goode T-Tube Insertion Forceps.....	276
Legent T-Tube Inserter.....	305
<b>TABB</b>	
Long Backhanded Elevator.....	55
Prosthesis Placement Hook.....	55
<b>TAKAHASHI</b>	
Nasal Forceps.....	78
Nasal Suction Forceps.....	82
<b>TARDY</b>	
Osteotome.....	93
<b>TELESCOPE SLEEVES/ACCESSORIES</b>	
Comeg Telescope Sleeve, 2°, W/Cleaning Port.....	377
Comeg Telescope Sleeve, 32°, W/Cleaning Port.....	377
Comeg Telescope Sleeve, 47°, W/Cleaning Port.....	377
Comeg Telescope Sleeve, 72°, W/Cleaning Port.....	377
Olympus Fiberoptic Light Source Adapter.....	378
Olympus Telescope Sleeve, 2°, W/Cleaning Port.....	378
Olympus Telescope Sleeve, 32°, W/Cleaning Port.....	378, 379
Olympus Telescope Sleeve, 47°, W/Cleaning Port.....	379
Olympus Telescope Sleeve, 72°, W/Cleaning Port.....	379
Storz Fiberoptic Adapter.....	380
Storz Telescope Adapter.....	380
Storz Telescope Sleeve, 2°, W/Cleaning Port.....	380
Storz Telescope Sleeve, 32°, W/Cleaning Port.....	380
Storz Telescope Sleeve, 47°, W/Cleaning Port.....	380
Storz Telescope Sleeve, 72°, W/Cleaning Port.....	381
Telescope Sleeve, W/Cleaning Port.....	382
Telescope Support Forceps.....	382
Wolf Fiberoptic Light Source Adapter.....	381
Wolf Telescope Adapter.....	380, 381
Wolf Telescope Sleeve, 2°, W/Cleaning Port.....	381
Wolf Telescope Sleeve, 32°, W/Cleaning Port.....	381
Wolf Telescope Sleeve, 47°, W/Cleaning Port.....	382
Wolf Telescope Sleeve, 72°, W/Cleaning Port.....	382
<b>TEIXIDO</b>	
Cartilage Cutter.....	265
<b>TEMPORAL</b>	
Bone Specimen Holder.....	305
<b>TENDON HOOK LARGE</b> .....	316
<b>TENOTOME</b>	
Probe.....	289
<b>TERRIER</b>	
Forceps.....	177
<b>TERRIS</b>	
Thyroidectomy Accessories.....	210
Malleable Retractor.....	210
Elevator.....	210
Suction Elevator.....	210
Suction Tube, Malleable.....	210
Thyroidectomy Instrument Set.....	209
Retractors.....	209
Elevators.....	209
Peanut Holder.....	209
Malleable Suction Elevator.....	209
Malleable Nerve Suction.....	209
Medium Instrument Tray.....	209
<b>TESSIER</b>	
Disimpaction Forceps.....	249
Dissecting Forceps.....	249
Dissecting Scissors.....	250
Osteotome.....	249
<b>THOMASSIN</b>	
Alligator Forceps.....	276
Elevator.....	271
Hook.....	280
Suction Tube.....	298
Tray Insert.....	302
<b>THRU-FLOW</b>	
Nasal Suction Forceps.....	82
<b>TIECK</b>	
Infant Nasal Speculum.....	114
<b>TIECK-HALLE</b>	
Speculum.....	372
<b>TISSUE FORCEPS</b>	
Adson Dressing / Tissue Forceps.....	178
Allis Tissue Forceps.....	164
Allis Tissue Forceps, Delicate.....	181
Babcock Tissue Forceps.....	164
Bishop-Harmon Tissue Forceps.....	147
Brown-Adson Tissue Forceps.....	147, 178
Chaput Tissue Forceps.....	196
DeBakey-Diethrich Vascular Tissue Forceps.....	181
Real Tissue Forceps.....	180
Tissue Forceps, 1 x 2 Teeth.....	179
Tissue Forceps.....	147

**TOBEY**

Ear Forceps ..... 15

**TONGUE DEPRESSORS**

Canuyt Tongue Depressor ..... 201  
 Chabolle Tongue Depressor ..... 198  
 Kilner Tongue Depressor ..... 199  
 Lecouteur Tongue Depressor ..... 201  
 Le Mee Tongue Depressor, W/Suction ..... 201  
 Portmann Tongue Depressor ..... 201  
 Tongue Depressor, Disposable ..... 201  
 Wieder Tongue Depressor ..... 127

**TONSIL DISSECTORS/RETRACTORS**

Hurd Dissector/Pillar Retractor ..... 123  
 Morrison-Hurd Dissector and Pillar Retractor ..... 123

**TONSIL FORCEPS**

Allis-Coakley Tonsil Forceps ..... 121  
 Birket Tonsil Seizing Forceps ..... 196  
 Bourgeois Tonsil Forceps ..... 196  
 Negus Tonsil Seizing Forceps ..... 197  
 O'Shaugnessy Tonsil Seizing Forceps ..... 197  
 Portman Tonsil Seizing Forceps ..... 197  
 Schnidt-Boettcher Tonsil Forceps ..... 122  
 Schnidt Tonsil Forceps ..... 122  
 Schnidt Tonsil Seizing Forceps ..... 197  
 St. Claire Thompson Adenoid Forceps ..... 122  
 White Tonsil Forceps ..... 122

**TONSIL KNIVES**

Fisher Tonsil Knife ..... 123

**TONSIL NEEDLES**

Tonsil Needle ..... 130

**TONSIL RETRACTORS**

Hurd Dissector/Pillar Retractor ..... 123  
 Love Uvula Retractor ..... 127  
 Morrison-Hurd Dissector and Pillar Retractor ..... 123  
 News Tracheal Retractor ..... 127

**TONSIL SCISSORS**

Dean Tonsil Scissors ..... 128  
 Guerrier Tonsil Scissors ..... 202  
 Metzenbaum Scissors ..... 128

**TONSIL SNARES**

Eve Tonsil Snare ..... 128  
 Sage Tonsil Snare, Straight Tip ..... 128  
 Snare Wire, Pre-Cut ..... 129  
 Tyding Tonsil Snare ..... 129  
 Vacher Tonsil Snare ..... 203

**TONSIL SUCTION TUBES/ACCESSORIES**

Andrews-Pynchon Suction Tube ..... 129  
 Andrews Suction Tube ..... 129  
 Yankauer Suction Tube ..... 129

**TONSILLECTOME**

Sluder Tonsillectome ..... 204

**TOWEL FORCEPS**

Backhaus Towel Forceps ..... 181  
 Non-Perforating Towel Forceps ..... 166  
 Ombredanne Towel Forceps ..... 181

Roeder Towel Forceps ..... 166

**TOYNBEE**

Speculum Round ..... 30

**TRACHEAL DILATORS**

Laborde Tracheal Dilator ..... 130, 225  
 Trousseau Tracheal Dilator ..... 130

**TRAUMANN**

Ear Loop ..... 285

**TRAYS/ACCESSORIES**

Charachon Ear Forceps Tray ..... 302  
 Instrument Holder Insert ..... 302  
 Instrument Tray, Laryngeal Forceps ..... 140  
 Laryngeal Instrument Tray ..... 139  
 Laryngoscope Tray ..... 170  
 Mustard Table ..... 170  
 Nasal and Sinus Instrument Trays ..... 118  
 Netterville Instrument Tray ..... 133  
 One-Level Tray ..... 167  
 Otology Instrument Tray ..... 302  
 Otology Tray Set ..... 60, 170  
 Pick Tray, Plastic ..... 169  
 Pick Tray ..... 61  
 Plastic Otology Tray ..... 61  
 Small Instrument Tray ..... 167  
 Stainless Steel Tray ..... 302  
 Thomassin Tray Insert ..... 302  
 Three-Level Modular Tray ..... 169  
 Three-Level Tray ..... 60, 169  
 Two-Level Tray ..... 61, 168

**TRELAT**

Elevators ..... 313

**TROCAR/CANNULAS**

Albertini Trocar and Cannula ..... 117  
 Lichtwicz Antrum Trocar Needle ..... 117  
 Ruskin Antrum Trocar Needle ..... 117  
 Sinus Trocar and Cannula ..... 117  
 Van Alyea Frontal Sinus Cannula ..... 117

**TROUSSEAU**

Tracheal Dilator ..... 130

**TUNGSTEN-CARBIDE**

Adson Tissue Forceps ..... 146  
 Becker, Wire Scissor ..... 161, 187, 329  
 Burrs ..... 247  
 Crile-Wood Needle Holder ..... 149  
 Fomon Dorsal Scissors ..... 107  
 Garabedian Needle Holder ..... 242  
 Garabedian Needle Holder Insert Only ..... 243  
 Glabella Rasp ..... 98  
 Halsey Needle Holder ..... 151  
 Iris Scissors, Sure Grip ..... 155  
 Kaye Facelift Scissors ..... 156  
 Mayo Scissors ..... 158  
 Mayo-Hegar Needle Holder ..... 151  
 Metzenbaum Scissors ..... 158  
 Nasal Rasps ..... 99, 323

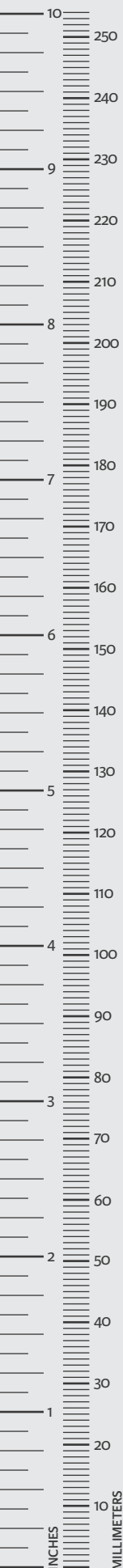

Olsen-Webster Needle Holder .....	151	Retractor .....	328
Parell Needle Holder .....	89	<b>VON EICKEN</b>	
Ryder Needle Holder .....	152	Suction Cannulas .....	116
Stratte Needle Holder .....	150	<b>W</b>	
Webster Needle Holder .....	152	<b>WALSHAM</b>	
<b>TYDING</b>		Septum Straightening Forceps .....	78
Tonsil Snare .....	129	<b>WATSON WILLIAMS</b>	
<b>U</b>		Nasal Polyp Forceps .....	79
<b>UNIVERSAL</b>		<b>WEBSTER</b>	
Universal Speculum Holder .....	30	Needle Holder .....	152
Universal Wire Suture Scissors .....	161	Needle Holder, W/Tungsten-Carbide Jaws .....	152
<b>UNIVERSITY OF MINNESOTA</b>		<b>WEIL</b>	
Cheek Retractor .....	100	Nasal Forceps .....	79
<b>UVULA</b>		<b>WEIL-BLAKESLEY</b>	
Goodyear Uvula Retractor .....	127	Forceps .....	363
Love Uvula Retractor .....	127	Forceps, Thru-Cut .....	80
<b>V</b>		Nasal Suction Forceps .....	81, 82
<b>V-SHAPED CHISEL</b> .....	311	Sinus Forceps .....	79, 80
<b>V-SHAPED GOUGE</b> .....	315	<b>WEIT</b>	
<b>VACHER</b>		Micro Elevator “Golf Club” Elevator .....	271
Nasal Speculum .....	335, 372	Scissors .....	334
Tonsil Snare .....	203	<b>WEITLANER</b>	
<b>VAN ALYEA</b>		Retractor .....	22, 291
Frontal Sinus Cannula .....	117	Retractor (Baby) .....	291
<b>VANNAS</b>		<b>WEITLANER-WULLSTEIN</b>	
Scissors .....	334	Retractor .....	291
<b>VAUGHAN</b>		<b>WERTHEIMER</b>	
Suction Sinus Instruments .....	343	Suction Tube .....	297
Punch Cleaner, 4.0mm and 6.0mm .....	343	<b>WHIRLYBIRD KNIFE</b> .....	41
Suction Picks .....	343	<b>WHITE</b>	
Suction Cup Forceps .....	343	Tonsil Forceps .....	122
Malleable Suctions .....	343	<b>WIEDER</b>	
Suction Mushroom Punches .....	343	Wieder Tongue Depressor .....	127
Suction Sickle Knife .....	343	<b>WIENER</b>	
Instrument Tray .....	343	Antrum Rasp .....	99
<b>VEAU</b>		<b>WIET</b>	
Rasps Single-Ended .....	324	Chronic Ear/Stapes Surgery Instruments .....	263
<b>VENT TUBE</b>		Alport Incus Hook .....	263
Cutting Block .....	305	Derlacki Mobilizer .....	263
<b>VIENNA</b>		Footplate Pick, Angled 45° .....	263
Nasal Specula Conventional .....	114	Harrison Knife .....	263
Nasal Specula Modified .....	115	House Barbara Pick, Sraight .....	263
Nasal Specula Original .....	114	House Crabtree Dissector Pick (Jimmy) .....	263
Nasal Speculum .....	372	House Gimmick Elevator .....	263
<b>VINCE</b>		House Lancet Knife #1 .....	263
Measuring Rod (Caliper) .....	286	House Pick, 3.0mm .....	263
<b>VINCENT</b>		Measuring Instrument .....	263
Punch .....	305	Needle .....	263
<b>VOLKMANN</b>		Perkins Retractors .....	263
Curettes .....	174, 311	Roller Knife .....	263
		Weit Micro Elevators .....	263
		Whirlybird Pick .....	263

**WILDE**

Dressing Forceps, Delicate ..... 80

**WINDOW RASP AND MARKER**

Paparella-Saunders Window Rasp and Marker ..... 51

**WIRE CUTTERS**

Becker Wire Scissors, W/Tungsten Carbide Blades .....  
161, 187, 329  
Guilford-Wright Wire Cutting Scissors ..... 161  
Universal Wire Suture Scissors ..... 162

**WOLF**

Fiberoptic Light Source Adapter..... 237, 381  
Telescope Adapter ..... 381  
Telescope Sleeve 2° W/Cleaning Port ..... 381  
Telescope Sleeve 32° W/Cleaning Port ..... 381  
Telescope Sleeve 47° W/Cleaning Port ..... 382  
Telescope Sleeve 72° W/Cleaning Port ..... 382

**WOO**

Laryngeal Scissors ..... 239

**WOODSON**

Elevator ..... 70

**WORK TABLE**

Hubbard Worktable W/Bracket..... 31  
Worktable Ossicle Holding Clamp..... 31  
Worktable Piston Trimming Gauge ..... 31  
Worktable Set ..... 31

**WORMALD**

Anterior Skull Base and Pituitary Instrument Accessories  
..... 346  
Anterior Skull Base and Pituitary Instrument Set ..... 344  
Bending Tool ..... 344  
Instrument Tray..... 344  
Malleable Probes ..... 344  
Malleable Suction Basket ..... 344  
Malleable Suction Curettes ..... 344  
Malleable Suction Elevator ..... 344  
Malleable Suction Probe..... 344  
Pituitary Forceps ..... 344  
Pituitary Scissors ..... 344  
Anterior Skull Base Clip-Applying Forceps ..... 364  
Bipolar Forceps with Suction ..... 365  
Frontal Sinus Surgery Instrument Set ..... 347  
Bending Tool ..... 347  
Instrument Tray..... 347  
Knot Pusher, 3.0mm ..... 347  
Malleable Sinus Probes..... 347  
Malleable Suction Curette ..... 347  
Malleable Suction Elevator ..... 347  
Hemorrhage Control Set ..... 346  
Clamps ..... 346  
Clip Applying Forceps ..... 346  
Instrument Tray..... 346  
Needle Holder ..... 346  
Hemorrhage Control Set Accessories ..... 346  
Clip Applying Forceps, Rotatable..... 346

**WULLSTEIN-WEITLANER**

Retractor ..... 22

**Y**

**YANKAUER**

Suction Tube ..... 129

**Z**

**ZIMMERMANN**

Suction Tube W/Luer Lock..... 301

**ZINI**

Mirror ..... 286

**ZYGOMATIC**

Zygomatic Arch Elevator ..... 70













Availability of these products might vary from a given country or region to another, as a result of specific local regulatory approval or clearance requirements for sale in such country or region.

- Always refer to the appropriate instructions for use for complete clinical instructions.
- Non contractual document. The manufacturer reserves the right, without prior notice, to modify the products in order to improve their quality.
- Warning: Applicable laws restrict these products to sale by or on the order of a physician.

---

## For more information or to place an order, please contact:

### United States, Canada, Asia, Pacific, Latin America

USA 800-654-2873 ▪ 888-980-7742 fax

International +1 609-936-5400 ▪ +1 609-750-4259 fax

[integralife.com](http://integralife.com)



Integra MicroFrance SAS  
Le Pavillon, 03160  
Saint-Aubin-le-Monial ▪ France



Integra York PA, Inc.  
589 Davies Drive  
York, PA 17402 ▪ USA